

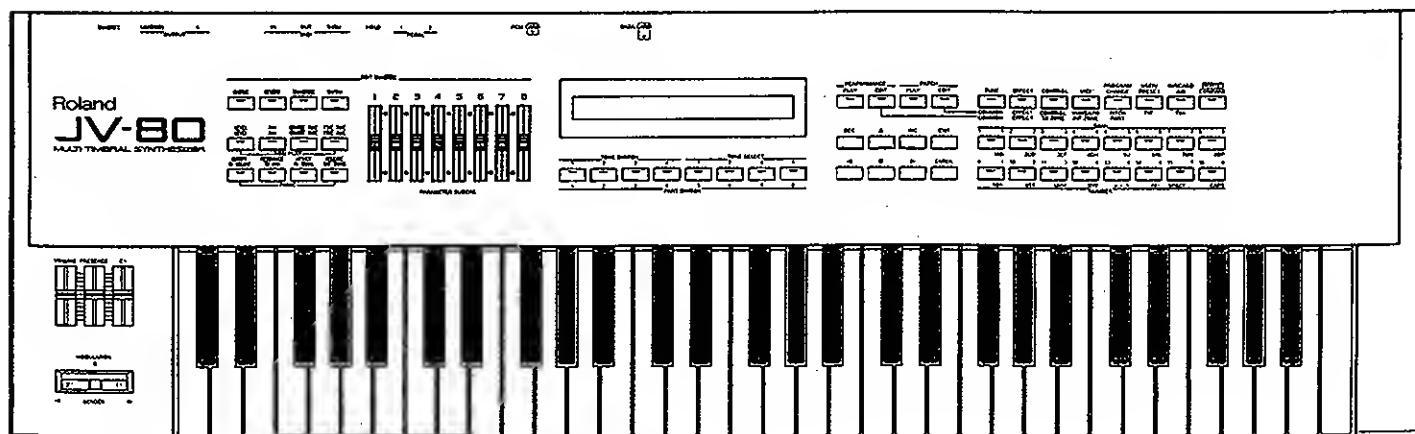

Roland

MULTI TIMBRAL SYNTHESIZER

JV-80

OWNER'S MANUAL



	CAUTION RISK OF ELECTRIC SHOCK DO NOT OPEN	
ATTENTION : RISQUE DE CHOC ELECTRIQUE NE PAS OUVRIR		
CAUTION: TO REDUCE THE RISK OF ELECTRIC SHOCK, DO NOT REMOVE COVER (OR BACK). NO USER-SERVICEABLE PARTS INSIDE. REFER SERVICING TO QUALIFIED SERVICE PERSONNEL.		



The lightning flash with arrowhead symbol, within an equilateral triangle, is intended to alert the user to the presence of un-insulated "dangerous voltage" within the product's enclosure that may be of sufficient magnitude to constitute a risk of electric shock to persons.



The exclamation point within an equilateral triangle is intended to alert the user to the presence of important operating and maintenance (servicing) instructions in the literature accompanying the product.

INSTRUCTIONS PERTAINING TO A RISK OF FIRE, ELECTRIC SHOCK, OR INJURY TO PERSONS.

IMPORTANT SAFETY INSTRUCTIONS

WARNING — When using electric products, basic precautions should always be followed, including the following:

1. Read all the instructions before using the product.
2. Do not use this product near water — for example, near a bathtub, washbowl, kitchen sink, in a wet basement, or near a swimming pool, or the like.
3. This product should be used only with a cart or stand that is recommended by the manufacturer.
4. This product, either alone or in combination with an amplifier and headphones or speakers, may be capable of producing sound levels that could cause permanent hearing loss. Do not operate for a long period of time at a high volume level or at a level that is uncomfortable. If you experience any hearing loss or ringing in the ears, you should consult an audiologist.
5. The product should be located so that its location or position does not interfere with its proper ventilation.
6. The product should be located away from heat sources such as radiators, heat registers, or other products that produce heat.
7. Avoid using the product where it may be affected by dust.
8. The product should be connected to a power supply only of the type described in the operating instructions or as marked on the product.
9. The power-supply cord of the product should be unplugged from the outlet when left unused for a long period of time.
10. Do not tread on the power-supply cord.
11. Do not pull the cord but hold the plug when unplugging.
12. When setting up with any other instruments, the procedure should be followed in accordance with instruction manual.
13. Care should be taken so that objects do not fall and liquids are not spilled into the enclosure through openings.
14. The product should be serviced by qualified service personnel when:
 - A. The power-supply cord or the plug has been damaged; or
 - B. Objects have fallen, or liquid has been spilled into the product; or
 - C. The product has been exposed to rain; or
 - D. The product does not appear to operate normally or exhibits a marked change in performance; or
 - E. The product has been dropped, or the enclosure damaged.
15. Do not attempt to service the product beyond that described in the user-maintenance instructions. All other servicing should be referred to qualified service personnel.

SAVE THESE INSTRUCTIONS

WARNING: THIS APPARATUS MUST BE EARTHED

For the U.K.

IMPORTANT: THE WIRES IN THIS MAINS LEAD ARE COLOURED IN ACCORDANCE WITH THE FOLLOWING CODE.
GREEN-AND-YELLOW: EARTH, BLUE: NEUTRAL, BROWN: LIVE

As the colours of the wires in the mains lead of this apparatus may not correspond with the coloured markings identifying the terminals in your plug proceed as follows:

The wire which is coloured GREEN-AND-YELLOW must be connected to the terminal in the plug which is marked by the letter E or by the safety earth symbol  or coloured GREEN or GREEN-AND-YELLOW.

The wire which is coloured BLUE must be connected to the terminal which is marked with the letter N or coloured BLACK.

The wire which is coloured BROWN must be connected to the terminal which is marked with the letter L or coloured RED.

The product which is equipped with a THREE WIRE GROUNDING TYPE AC PLUG must be grounded.

**MULTI TIMBRAL
SYNTHESIZER**

JV-80

Owner's Manual

Introduction

Thank you for purchasing the Roland JV-80 Multi Timbral Synthesizer. To take full advantage of the JV-80's functions, and to enjoy long and trouble-free use, please read this owner's manual carefully.

Copyright © 1991 by ROLAND CORPORATION

All rights reserved. No part of this publication may be reproduced in any form without the permission of ROLAND CORPORATION.

HOW TO USE THIS MANUAL

This manual consists of the following sections describing the respective modes of the JV-80. Though we recommend that you take time to read through this entire manual once, those who have a general knowledge about synthesizers can read the desired sections as needed when using the instrument.

Section 1 : Setting Up and Playing the JV-80

This section covers preparation before play, ROM Play operations, connection to external devices, and trying out the various sounds of the JV-80.

Section 2 : General Overview

This section covers the structure of the sound sources of the JV-80, and Patches and Performances, which are the units of sound.

Section 3 : Play

This section covers the operations for using the JV-80 in the Play mode (Patch Play/Performance Play) and describes the functions of the parameters related to this mode.

Section 4 : Edit

This section covers the operations of the modes (Patch Edit/Performance Edit/Rhythm Edit) which are used to edit sound program data (Patch/Performance/Rhythm Tone), and describes the functions of parameters related to these modes.

Section 5 : Command

This section covers the operations and functions of the Write mode, which include the storing of edited data and organization of the data.

Section 6 : Reference

This section includes a list of error messages, a sound program data list and MIDI implementation. Also, an index of operations and the main index will help you in using this manual. By using the index of operations, you can quickly find the pages that contain information about the operations and functions you want to know about.

●The explanations contained in the pages you refer to have been made as comprehensive as possible. Since many functions and operations throughout the JV-80 are quite similar, you may find repetition of the same or similar information in several sections.

●In the Play section and the Edit section, concrete application examples are given before explanation of the parameters of a function and the method for operating and setting them. (An asterisk ★ indicates the examples.) The resulting sound applications in using the parameters (and the effective ways of setting them) are given at the beginning of each section of Patch/Performance in the Play section and at the beginning of each item of Patch/Performance in the Edit section. Following these explanations, the basic functions of each parameter are explained.

■ Panel Indications

The buttons and switches used in operation are referred to in this manual just as their names appear on the panel, printed above (or below) each button.

[Example]

Chorus button → **CHORUS**
Tone switch → **TONE SWITCH**
Cursor buttons → **◀/▶**

The parameter names are expressed as **Mode** or **ChoRate**. Since they are usually given as abbreviations, the full names are written next to them: for example, "key mode" and "chorus rate." Then the editable range of the parameter is given: for example, 0 — 127 for a continuous one, or - 100/ - 50/0/50/100 for specified (step) ones.

■ Display

The various functions of the instrument are accessed through the display. Please keep in mind that there may be slight differences between the data (like in sound program names) in factory settings and the displays shown in the manual.

CONTENTS

■ MAIN FEATURES OF THE JV-80	7
■ IMPORTANT NOTES	8
■ PANEL CONTROLS AND TERMINALS	9

SECTION 1 SETTING UP AND PLAYING THE JV-80

1. CONNECTING THE JV-80 TO EXTERNAL EQUIPMENT	12
2. TURN THE POWER ON	13
■ Adjusting the Contrast of the LCD	14
3. LISTENING TO THE ROM PLAY FEATURE	15
4. PLAYING THE JV-80	17
■ Trying Out the Realtime Performance Functions	18
■ Switches	19

SECTION 2 GENERAL OVERVIEW OF THE JV-80

1. MODES	22
2. TWO TYPES OF SOUND UNITS (PATCHES AND PERFORMANCES)	23
■ Patches and Tones	23
■ Performances and Patches	24
3. SOUND SOURCE AND CONTROLLERS	25
4. ORGANIZATION OF THE SOUND SOURCE	27
■ Internal Sound Source	27

SECTION 3 PLAY

1. PLAYING PATCHES	30
■ What is the Patch Play mode?	30
■ Parameters Available for Realtime Control	31
■ Operation	33
● Selecting the Patch Play Mode	33
● Changing Patches	33
● Selecting and Adjusting the Patch Parameters with the Assign Buttons	34
● How to use the TONE SWITCH	35
■ Explanations of the Parameters	36
LEVEL	36
PAN	39
COARSE TUNE	41

FINE TUNE	43
CUTOFF	44
RESONANCE	46
The parameters called up by the ATTACK / RELEASE buttons	47

2. PLAYING A PERFORMANCE	51
■ What is the Performance Play mode?	51
■ Parameters Available for Realtime Control	52
■ Operation	56
● Selecting the Performance Play Mode	56
● Changing Performances	56
● Selecting and Adjusting the Performance Parameters with the Assign Buttons	57
● How to use the PART SWITCH	58
■ Explanations of the Parameters	59
● Part Parameters	59
LEVEL	59
PAN	59
COARSE TUNE	59
FINE TUNE	59
● Transmit Zone Parameters	62
TX VOLUME	62
TX PAN	62
TX TRANS	63
● Internal Zone Parameters	66
INT TRANS	66
3. Other Play Operations	68
■ Operation	68
■ Explanations of the Parameters	69
EFFECT	69
PROGRAM CHANGE	70
● Panic function	71
4. System Common Parameters	72
■ Operation	72
■ Explanations of the Parameters	73
TUNE	73
CONTROL	73
MIDI	75

SECTION 4 EDIT

1. Patch Edit	78
■ What is the Patch Edit mode?	78
■ How to Edit in the Patch Edit Operations	80
● Using TONE SELECT	81
● Selecting Parameters with the Assign Buttons	81

- Explanations of the parameters 83
 - Parameters Selected by **COMMON** 83
 - Parameters Selected by **EFFECT** 85
 - Parameters Selected by **CONTROL** 90
 - Parameters Selected by **WAVE/LFO** 95
 - Parameters Selected by **PITCH** 101
 - Parameters Selected by **TVF** 105
 - Parameters Selected by **TVA** 110
- 2. Performance Edit** 115
 - What is the Performance Edit mode? 115
 - How to edit a Performance 117
 - Using **PART SWITCH** 118
 - Explanations of the parameters 120
 - Performance Common Parameters** 120
 - Parameters Selected by **COMMON** 120
 - Parameters Selected by **EFFECT** 122
 - Transmit Zone Parameters** 124
 - Parameters Selected by **TX ZONE** 126
 - Internal Zone Parameters** 130
 - Parameters Selected by **INT ZONE** 131
 - Part Parameters** 134
 - Parameters Selected by **PART** 136
- 3. Rhythm Edit Mode** 139
 - What are rhythm sound programs? 139
 - Rhythm Tone Editing 139
 - Explanations of the parameters 141
 - Parameters Selected by **EFFECT** 141
 - Parameters Selected by **CONTROL** 143
 - Parameters Selected by **WAVE/LFO** 144
 - Parameters Selected by **PITCH** 145
 - Parameters Selected by **TVF** 147
 - Parameters Selected by **TVA** 150

SECTION 6 REFERENCE

- 1. Error Messages** 168
- 2. Troubleshooting** 170
- 3. Waveform List** 174
- 4. Initialize Data** 175
- 5. Factory Setting** 180
- 6. Blank Chart** 184
- 7. Operation Examples of the JV-80** 189
- Roland Exclusive Messages** 197
- MIDI Implementation** 199
- MIDI Implementation Chart** 207
- **Multi Sound Source for Desktop Music and Home Studio Applications** 209
- **Main Specifications** 210
- **Index of Functions and Operations** 219

SECTION 5 COMMAND

- **Write Mode** 154
 - **Operation** 154
 - Write 155
 - Copy 157
 - Initialize 160
 - Card 161
 - Bulk (Bulk Dump) 164
 - Protect 166

MAIN FEATURES OF THE JV-80

The JV-80 is an advanced synthesizer with built-in sound sources that give you a wide range of sound shaping features. These allow you to use flexible filter (TVF) and amplifier (TVA) controls to process the various high-quality sound elements. Because of the rich built-in sound sources and the comprehensive MIDI control functions which let you make changes to the sounds and various parameters in realtime, the JV-80 is ideal for both live performance situations and desktop music applications.

● Various Modes for Powerful Performance Potential

The JV-80 features two operating modes: the Patch Play mode, which enables you to use the full expressive capabilities of the JV-80 by playing a single sound in realtime, and the Performance Play mode, which allows you to play eight different Parts (internal sound sources) over eight different MIDI channels. In the Key mode, there is a Solo mode that lets you make special key assignments, along with portamento for playing expressive melody lines in legato.

● Wide Range of Sound Waveforms

Naturally, the JV-80 provides basic synthesizer waveforms, such as the sawtooth wave, square wave and pulse wave. It also features built-in waveforms that have various frequency elements or short 'actual' sounds.

Since waveforms can be processed by FXM (Frequency Cross-Modulation), the JV-80 is capable of satisfying the most demanding sound programming applications, from recreating realistic sounds to producing unusual, otherworldly effects. New waveforms can also be added by installing the optional PCM card or expansion board.

● Built-in Digital Effects

Chorus and reverb effects are built into the JV-80. Rich stereo effects that add spaciousness and depth to the sound can be gained by using chorus and reverb.

● Flexible Realtime Parameter Control

Control over individual parameters can be assigned to the sliders or footswitches/pedals. The expressive potential is enormous, since a wide range of parameters can be selected for independent and simultaneous control.

● Touch-sensitive Keyboard

The keyboard of the JV-80 features velocity and aftertouch sensitivity. This allows you to change the tonal quality and volume of the sound by how strongly you hit the keys or how strongly you press down on them after hitting them.

● Ease of Operation

In order to simplify play and edit operations, the JV-80 has a large LCD display (40 characters by 2 lines) with corresponding soft keys which are used to directly select the assigned parameters in the display.

● Convenient Performance Functions

Even during performance, the sound programs and their parameters can be adjusted in realtime (and over MIDI) with the use of the Parameter Sliders. This makes it easy to adjust the sound to match the performance situation or the character of the song.

● Multi-timbral Operation

The JV-80 features multi-timbral capacity with seven independent synthesizer Parts and one rhythm Part. This allows you to create the sound of an ensemble or group with just the JV-80, controlling the sound sources over MIDI.

● Memory Card

By using an optional DATA card (M-256E), the internal settings can be stored. Sound program data which is stored on the DATA card can be called up for use while playing.

● Convenient Panic Function

The JV-80 has a panic function that lets you quickly cut off 'stuck' notes when using the unit to control other MIDI sound sources.

■ IMPORTANT NOTES

In addition to the items listed under Safety Precautions on page 2, please read and adhere to the following:

[Power Supply]

- When making any connections with other devices, always turn off the power to all equipment first; this will help prevent damage or malfunction.
- Do not use this unit on the same power circuit with any device that will generate line noise, such as a motor or variable lighting system.

[Placement]

- This unit may interfere with radio and television reception. Do not use this unit in the vicinity of such receivers.

[Maintenance]

- For everyday cleaning wipe the unit with a soft, dry cloth (or one that has been slightly dampened with water). To remove stubborn dirt, use a mild neutral detergent. Afterwards, be sure to wipe the unit thoroughly with a soft, dry cloth.
- Never use benzene, thinners, alcohol or solvents of any kind, to avoid the risk of discoloration and/or deformation.

[Additional Precautions]

- Protect the unit from strong impact.
- Never strike or apply strong pressure to the display.
- A small amount of heat will radiate from the unit, and thus should be considered normal.
- Before using the unit in a foreign country, consult with qualified service personnel.

[Memory Backup]

- The unit contains a battery which maintains the contents of memory while the main power is off. The expected life of this battery is 5 years or more. However, to avoid the unexpected loss of memory data, it is strongly recommended that you change the battery every 5 years. Please be aware that the actual life of the battery will depend on the physical environment (especially temperature) in which the unit is used. When it is time to change the battery, consult with qualified service personnel.
- The unit's battery functions during normal operation as well as maintaining the contents of memory when the main power supply is turned off. When the battery becomes weak, there is a risk of losing the contents of the memory. To avoid the unexpected loss of memory data, replace the battery before it becomes weak.
- When the battery becomes weak, the following message will appear in the display: "Internal Battery Low". Please change the battery as soon as possible to avoid the loss of memory data.
- Please be aware that the contents of memory may at times be lost; when the unit is sent for repairs or when by some chance a malfunction has occurred. Important data should be stored on a DATA card, or written down on paper. During repairs, due care is taken to avoid the loss of data. However, in certain cases, (such as when circuitry related to memory itself is out of order) we regret that it may be impossible to restore the data.

[Expansion Board]

- When using the optional expansion board, refer to the expansion board manual for the instructions on installation and use of the board.

PANEL CONTROLS AND TERMINALS

Front panel

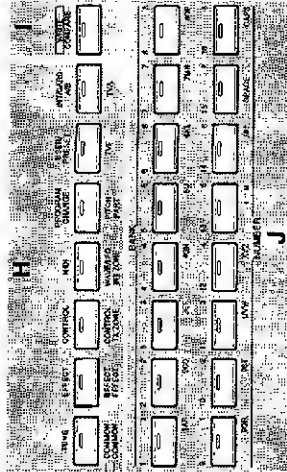
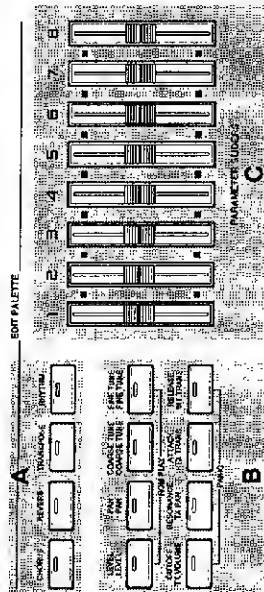

Side panel

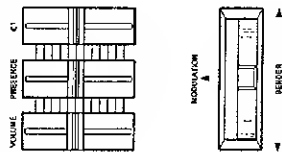

Master Volume Slider

This slider adjusts the output from the output jacks and headphone jack.

Presence Controller

This slider adjusts the density and brightness of the total instrument sound.

C1 Slider

This slider lets you change the sound of internal sound sources in real time. The parameters controlled in this way are user-assignable.

Bender/Modulation Lever

This lever can control several functions, such as bending of pitch and applying vibrato.

A

Chorus Button

This button turns the chorus effect for the entire instrument on and off. The indicator lights up when chorus is turned on. This on/off switch has priority over other chorus controls.

Reverb Button

This button turns the reverb effect for the entire instrument on and off. The indicator lights up when reverb is turned on. This on/off switch has priority over other reverb controls.

Transpose Button

This button turns the key transpose settings for the entire instrument on and off. The indicator lights up when key transpose is turned on.

Rhythm Button

Pressing this button selects the Rhythm Edit mode (the mode used to set the Rhythm Tone and Rhythm Set).

B

Assign Buttons

These buttons select the parameters to be assigned to the eight Parameter Sliders for realtime control (in Patch/Performance Play modes). The letters emitted in orange on the buttons indicate the parameters controllable in the Patch Play mode, and the letter pink in blue indicate the parameters controllable in the Performance Play mode.

C

Parameter Sliders

These sliders are used when changing the set values of the parameters shown in the display — — for example, when editing sound programs — — and controlling external MIDI events.

D

LCD Display

This indicates various information of the JV-30 according to the selected operation.

E

Tone Switches 1 — 4

These switches turn the sound of the Tone on and off in the Patch Play/Edit mode. The indicator lights up when the Tone is on.

Tone Select Buttons 1 — 4

These buttons select the Tone to be called up in the display in Patch Play/Edit. It is possible to select several Tones simultaneously by pressing several buttons at the same time. The # indicator shows the Tone currently selected.

Part Switches 1 — 8

These function as on/off switches for receiving and transmitting MIDI data of each Part, and on/off switches for the sounding of each Part. The functions to be turned on and off change according to the assign button currently selected.

F

Mode Select Buttons

These buttons select the mode in which the JV-30 is operated: modes for playing the instrument (Patch Play/Performance Play) and modes for adjusting the sound programs (Patch Edit/Performance Edit).

G

INC/DEC Buttons

These buttons are used to change the set values of the parameters which are indicated on the display. Pressing the INC button increases the value in single unit increments, and pressing the DEC button decreases the value in single unit increments.

Page Buttons (▲/▼)

When "▲" or "▼" are shown at the bottom right of the LCD, these buttons are used to select the other available parameter setting pages. The next page is selected by pressing "▼", and the previous page is selected by pressing "▲".

Cursor Buttons (←/→)

These buttons are used when moving the underlined portion (cursor) displayed in the LCD, or when entering a command. Pressing the ← button moves the cursor to the left, and pressing the → button moves it to the right.

EXIT Button

This button is used to cancel the current operation. Pressing this button once returns the display to the previous page.

ENTER Button

This button is used to execute a command.

※The INC/DEC, page, cursor buttons feature an auto repeat function (which has the same effect as pressing the same button repeatedly) when one of the buttons is held down. You can speed up the change in values by holding down one button (▲, ▼, ←, →) and then pressing and holding down the opposite button (▲, ▼, ←, →).

H

Function Selected Buttons

By pressing one of these buttons, the chosen function (parameter) is called up. The selected function or parameter differs depending on the mode.

I

Write Button

Pressing this button selects the Write mode in which edited data is stored and commands touch to that of copying data) are executed.

J

Bank/Number Buttons

These buttons are used to select the sound program (Performance or Patch). In order to select a Performance, use buttons 1 — 16 (indicated by the blue numbers at the top left of the buttons). When selecting a Patch, use both the Bank buttons 1 — 8 and the Number buttons 1 — 8. These buttons are also used to input characters when naming Performances and Patches.

Rear Panel

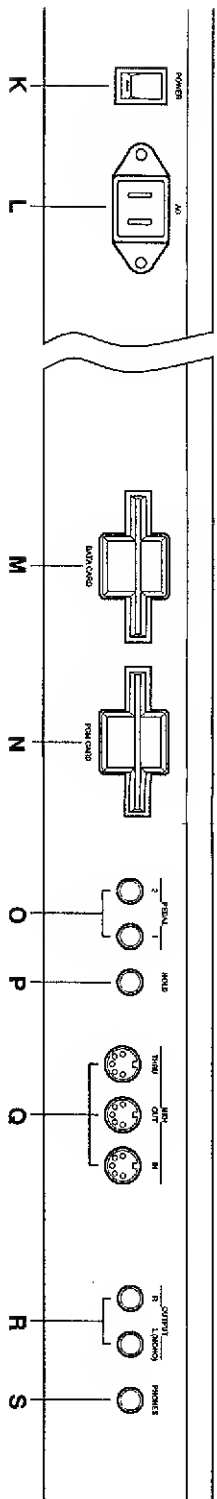

K

Power Switch

This switch turns the power on and off.

L

AC Connector

The power cord is connected here.

M

DATA Card Slot

Insert optional DATA cards (M-258E, etc.) here.

N

PCM Card Slot

Insert optional PCM cards, made especially for the JV-90, here.

O

Pedal Jacks 12

Optional pedal switches (FS-1, DP-2, etc.) and expression pedals (EV-6, EV-10) can be connected to these jacks. By assigning specific functions to the connected pedal, it can be used to control various operations (such as sustain/hold functions and program changes).

P

Hold Pedal Jack

Optional pedal switches (FS-1, DP-2, etc.) can be connected to these jacks to control trigger functions.

Q

MIDI Connectors (IN/OUT/THRU)

These connectors allow the JV-90 to be connected to other MIDI devices when sending and receiving MIDI data.

R

Output Jacks

These jacks output the stereo audio signal to an amplifier or mixer. Connecting a cable to only the left jack (L) results in mono output.

S

Phones Jack

This jack is for connection of a set of headphones. We recommend that you use Roland TR-2050R/20 headphones (optional). The audio signal is also output through the main output jacks even when headphones are connected.

SECTION 1

***SETTING UP AND
PLAYING THE JV-80***

1. CONNECTING THE JV-80 TO EXTERNAL EQUIPMENT

Since neither an amplifier or speakers is built into the JV-80, you should have some kind of amplification/speaker system in order to hear the instrument. When using a set of headphones, insert the headphone plug into the PHONES jack on the JV-80.

When using an amp/speaker setup, be sure the volume of the amplifier is at minimum before turning the system on. This will help prevent damage to your speaker systems.

When using the optional PJ-1M cable, the instrument can be directly connected to the jacks of a stereo set by removing the phone plug adaptors and using the RCA pin connectors.

We suggest that you use the stereo outputs of this instrument to take full advantage of the functions of the JV-80. However, if you require a mono output, use only the L (MONO) jack.

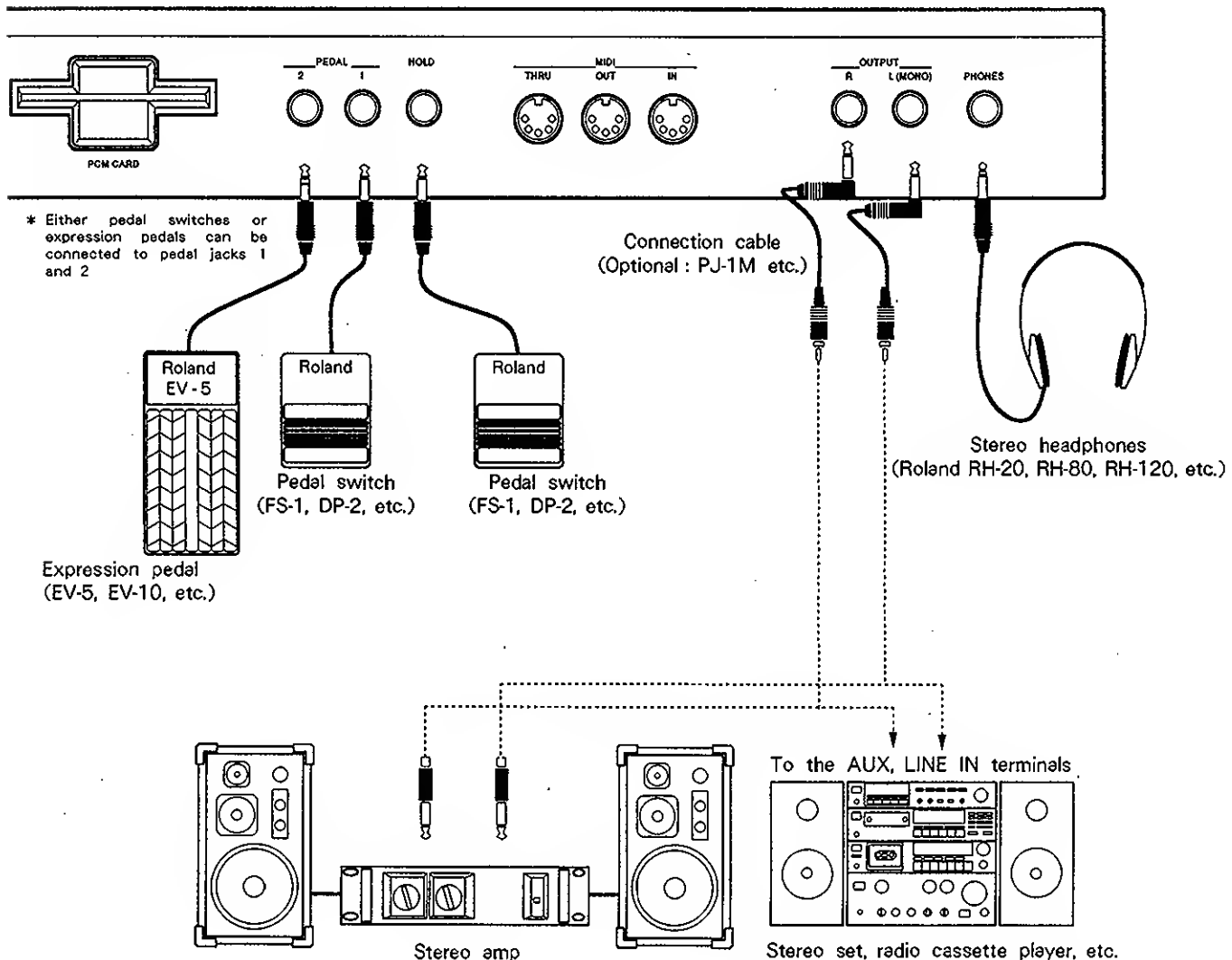

2. TURN THE POWER ON

After making the proper connections, turn on the power according to the procedure given below.

[1] Before you turn on the power, check the following points:

- Are all connections made correctly?
- Are the volume controls of the amplifier and other equipment turned down?
- Is the volume control of the JV-80 turned down?

[2] Turn on the power switch on the rear panel of the JV-80. The following display appears. The JV-80 has a protection circuit that mutes the output for a few seconds after the power is turned on.

【Example of the display】

```
PERFORM #PERFORM NAME:      Part Level
I01      #127|127|127|127|127|127|127|127
```

※ Upon power up, the JV-80 recalls the last selected Performance or Patch.

[3] Turn on the power of the connected devices, such as the amplifier, and adjust the volume.

[4] Adjust the sound volume with the master volume control of the JV-80.

VOLUME



↑ Maximum
volume

↓ Minimum
volume

※ Adjust the sound at the TVA level (P.36), Resonance (P.46) or the Part level (P.59) if the sound is still distorted even after adjusting the overall level with the master volume slider.

[5] When turning off the power, first turn off the external devices, then turn off the JV-80.

※ Be careful not to set the output level too high when connecting the JV-80 directly to an audio system. The speakers may be damaged by an excessive volume level.

■ Adjusting the Contrast of the LCD

Occasionally, the characters in the display may be difficult to read, depending on existing lighting conditions and the placement of the JV-80. If this is the case, adjust the contrast of the LCD according to the steps given below.

- 【1】** Press either **PERFORMANCE PLAY** or **PATCH PLAY**. (The indicator of the button will light.)
- 【2】** Press **TUNE**. (The indicator will light.)

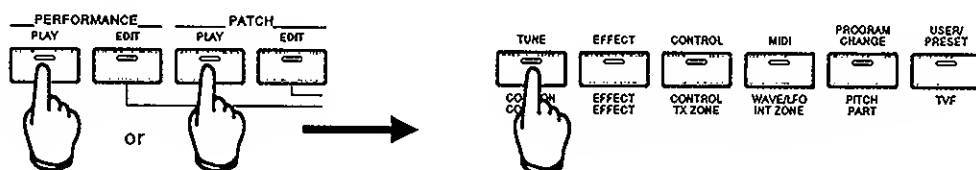

- 【3】** Adjust the contrast by using Parameter Slider 3.

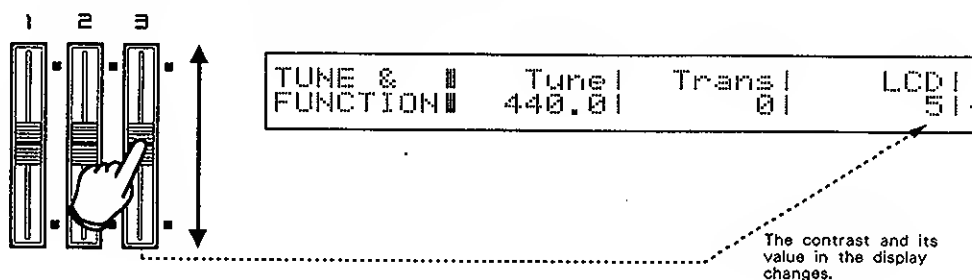



- 【4】** Press **TUNE** once you finish adjusting the contrast. (The indicator goes out.)

※ You can also return to individual modes by pressing the mode select buttons.

3. LISTENING TO THE ROM PLAY FEATURE

The JV-80 contains several demo songs that showcase the various sophisticated functions of the instrument, such as the multi-timbral capabilities and the Solo mode. The ROM Play function automatically plays these songs. We suggest that you connect a stereo amplifier or listen through a set of stereo headphones in order to get the full benefit of the JV-80's advanced capabilities.

- [1]** While holding down the  button, press the  button. This selects the ROM Play mode.

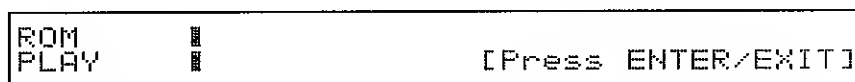
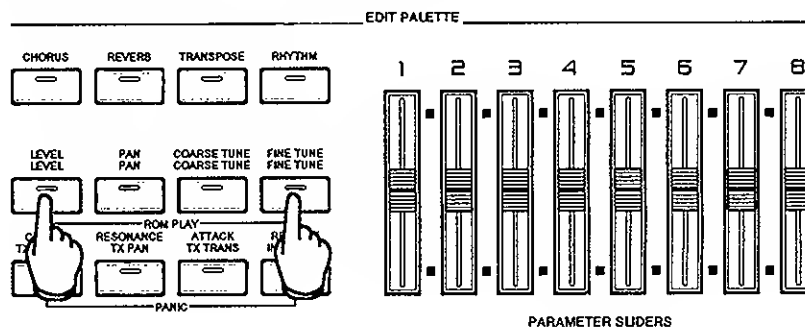

- [2]** Press **ENTER** to start playback from the first song. Adjust the volume of playback by using the MASTER VOLUME slider. Press **EXIT** to stop playback.

1	Introduction	Songs 1 through 5 are parts that play back as a medley, and together form one whole song. Music by Eric Persing Copyright © 1991, Eric Persing Music
2	House Sounds	
3	Cosmo Space	
4	Acoustics	
5	Finale!!	
6	Perseverance	Music by Adrian Scott Copyright © 1991, Adrian Scott
7	New Listening	

- [3]** Press **EXIT** after playback has stopped. This returns the instrument to the standard operating mode.

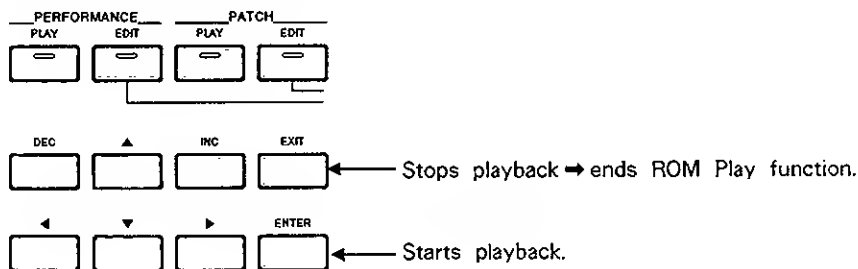

- ✘ Keys or buttons other than those described above will not function, since all other functions of the JV-80 are temporarily suspended during ROM Play.
- ✘ The notes and other musical data of the ROM Play are not transmitted from the MIDI OUT terminal.

● Profiles of the composers

Eric Persing
Eric Persing is one of the most in-demand session players and programmers in the Los Angeles area. Eric began working for Roland as a product specialist, first doing clinics and support, then gradually became more involved in product and sound design. Eric has worked with such artists as Michael Jackson, Chaka Khan, Larry Carlton, Marcus Miller, and Bon Jovi. His music and sounds can also be heard on many TV shows and commercials. Actively involved in film music, he has worked with top composers including Michel Colombier, Danny Elfman, and Bill Conti.
Adrian Scott
Adrian was the keyboardist and vocalist for the world-famous hit-making Australian pop group Air Supply. After pursuing a solo career, he captured the silver prize at the World Song Festival Tokyo '84 in 1984. As a session musician, he has backed up many famous Australian artists, including John Farnham and Kylie Minogue. He currently resides in Melbourne and is active as a producer of commercial music and film music.

※ Warning : All rights reserved. Unauthorized use of this material is a violation of applicable laws.

■ The chart below lists the Patches used in each of the demo songs.

1	Introduction	A11: A.Piano 1	A88: Stereoww Bs	B18: Orch Strings
2	House Sounds	A11: A.Piano 1	A76: House Bass	A86: Rubber Bs 1
		A82: Thumpin Bass		
3	Cosmo Space	B86: Big n Beefy	B83: JP - 8 Pad	B37: GlassVoices
		B88: Analog Seq	B21: Slow Strings	
4	Acoustics	A56: Velo Harmnix	A55: 12 strings	A72: St Fretless
		B21: Slow Strings		
5	Finale!!	B21: Slow Strings	B18: Orch Strings	B22: Velo Strings
6	Perseverance	A83: Pick Bass	A66: Funk Gtr	B36: Pvox Oooze
		A85: Yowza Bass	A25: Dig Rhodes 2	B87: RevCymBend
		A65: Clean Start	B34: Beauty Vox	A24: Dig Rhodes 1
		A37: Wave Bells	A88: Stereoww Bs	B56: AltoLead Sax
		B68: Air Lead	B52: Stab Brass	B87: RevCymBend
7	New Listening	A51: Nylon Gtr 1	A75: Analog Bs 1	B25: Orch Stab 1
		A15: Pop Piano 2	B84: Puff	A64: Pop Strat
		B46: Brass Sect 1	B44: Hatmon Mute2	B57: Alto Sax
		B23: BrightStrngs		

★ Rhythm Set : 1-6 = preset B 7 = preset A

4. PLAYING THE JV-80

When the JV-80 is shipped, it contains settings (Patches) of preset sounds. This section will explain the various sounds and how to select them.

First turn on the power, then press **PATCH PLAY**. You can now play the instrument from the keyboard.

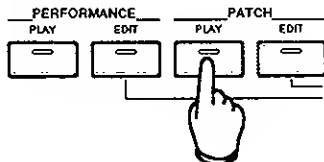

```
PATCH  #A.Piano 1      : TWA Level1
I11    #   1271      1271 1271 127
```

Try playing the instrument and listening to various sounds by changing Patches.

The numbers 1 — 8 printed in orange on the **BANK** / **NUMBER** buttons at the right side of the panel indicate the bank and number of the Patch. Patches numbered 11 — 88 can be selected using both the **BANK** and **NUMBER** buttons. The numbers (Patch number) and the letters (Patch name) in the LCD change according to the buttons that are pressed.

You can also select additional Patches.

By combining **USER/PRESET** and **INT/CAR A/B**, the following can be selected:

User memory, Internal and Preset are described in detail in the next section of this manual, "ORGANIZATION OF THE SOUND SOURCE," P.27.

- User memory → Internal 11 — 88
- Card 11 — 88 (when an optional DATA card is used)
- Preset → A 11 — 88, B 11 — 88

Try playing the different sounds, switching between Patches by pressing these buttons.

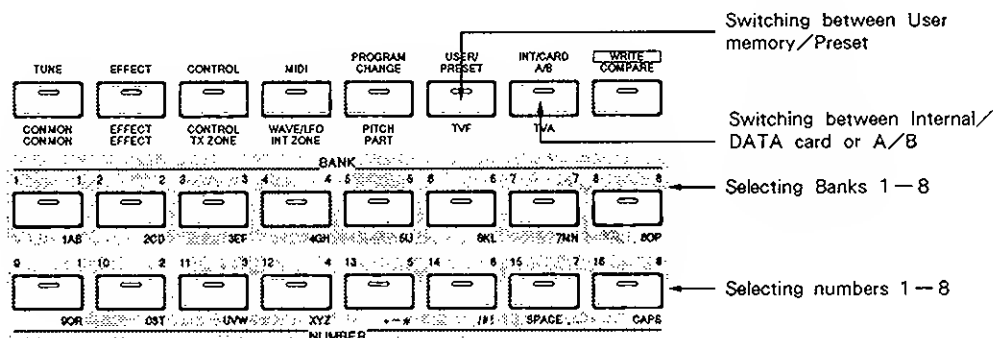

The Patch currently selected can be confirmed by checking the display.

- I 11 — 88 → Internal Patches (User memory)
- C 11 — 88 → Card Patches (User memory)
- A 11 — 88 → Patches of Preset A
- B 11 — 88 → Patches of Preset B

■ Trying Out the Realtime Performance Functions

The JV-80 has various controls for altering the sound as you play. Try out some of these functions while playing the keyboard. The application of effects can also be determined for individual sound programs by using the same controllers.

Listen to some of the differences by selecting other Patches.

● Velocity/Aftertouch

The volume and the tonal quality (or timbre) of the sound will change according to your playing dynamics (velocity), or how hard you strike the keys. The action of pressing a key down after playing it is called "aftertouch." Pitch, tone and volume can also be changed using aftertouch.

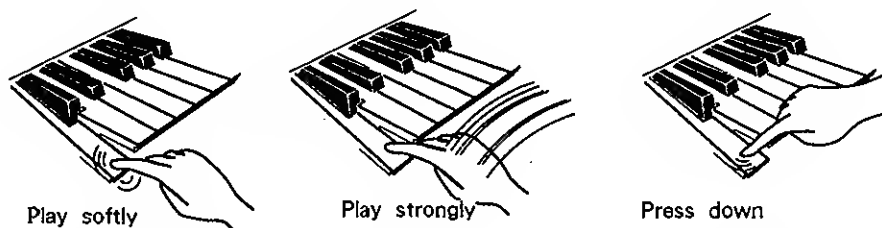

● Bender/Modulation Lever

While playing a note, you can move the Bender/Modulation Lever to the left to lower the pitch, or to the right to raise the pitch. This is called the pitch bend effect. You can also push the lever forward to add expressive modulation effects, such as vibrato or tremolo, while you play.

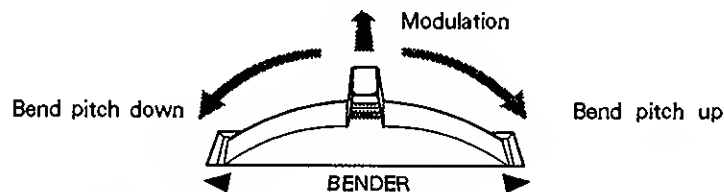

● C1 Slider

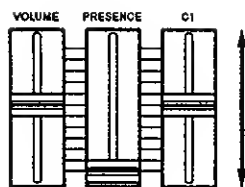

The volume and tone of the sound can be changed by moving this slider up and down while playing the keyboard. The functions of the slider differ depending on the settings.

● Presence Controller

This is used to change the tonal quality of the sound; it adjusts the brightness and clarity. The higher the lever is moved the more pronounced the effect becomes.

- ※ Further expressive control is available with a pedal switch (FS-1 or DP-2) or expression pedal (EV-5 or EV-10). By connecting a pedal switch to the HOLD jack on the rear panel, you can have the sound sustain even after you release the keys. By connecting an expression pedal to one of the pedal jacks, you can use the pedal to change the volume or the tone of the sound.
- ※ you can also change various aspects of the sound in realtime by using the eight parameter sliders. see the Play Section (P.34, 57) for more details.

Switches

By using the buttons on the top left side of the front panel, you can conveniently turn on and off the internal stereo effects (chorus and reverb) and the internal transpose function.

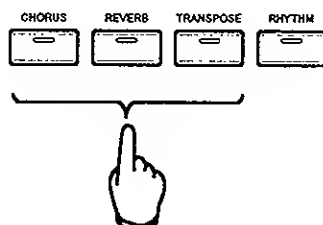

CHORUS

This button turns the chorus effect on and off.

REVERB

This button turns the reverb effect on and off.

TRANSPOSE

This button is used to turn the transpose function, set in the transpose parameter (P.73) of the system common parameters, on and off. There is no pitch transposition when the system common transpose parameter is set to 0.

SECTION 2

*GENERAL OVERVIEW
OF THE JV-80*

1. MODES

The sound programs of the JV-80 Performance Synthesizer can be called up and played in two different ways. One is by using a *Patch*, which is the basic sound program of the instrument, and the other is by using a *Performance*, which is a combination of seven Patches and one Rhythm Set. Different modes are available depending on which sound program (Patch or Performance) is selected.

Patch Play mode (P.30)

This mode plays sounds by calling up one Patch at a time. By using the eight sliders or an optional foot pedal, you can make various realtime changes in the sound and volume and even change sound programs as you play. This mode lets you operate the JV-80 as you would a conventional synthesizer.

Performance Play mode (P.51)

Since a Performance can combine up to eight different Patches, much thicker and richly textured sound programs can be created. Performances can also be used to create ensemble sounds by using different Patches to play different parts. This mode also lets you add dynamic changes and movement to your music by changing the volume and pan settings for each Patch as they are played.

Patch Edit mode (P.78)

This mode is used to access the synthesizer sound creation features of the instrument. In this mode, you can change the various elements which determine the character of the sound programs and create new Patches.

Performance Edit mode (P.115)

By combining seven Patches and one Rhythm Set as component parts of a sound, this mode lets you set the overall sound or effect that you wish to create. In this mode, the JV-80 can adapt to a wide range of applications. It can be used as a keyboard for live performance, in which you can make dynamic changes to the sound as you play by key velocity or by using connected pedals. It can also be set up as an all-purpose multiple sound source for desktop music and home studio applications.

Rhythm Edit mode (P.139)

This mode changes the settings of the Rhythm Set that is assigned to a Performance. A Rhythm Set is a group of individual Rhythm Tones, which are assigned to each key of the keyboard. This mode also allows you to set various parameters that control and change the sound of each Rhythm Tone.

※ *In addition to the modes mentioned above, there is a Write Mode (P.154) which allows you to store and organize your original sound program data.*

2. TWO TYPES OF SOUND UNITS

(PATCHES AND PERFORMANCES)

■ Patches and Tones

A Patch is the individual sound program unit of the JV-80. Patches themselves are made up of *Tones*. It is possible to create a Patch by using only a single Tone; however, sounds of remarkable complexity and clarity can be created by using up to *four* Tones in a Patch. Doing this, however, limits the maximum number of voices (notes) that can sound simultaneously, since several voices are used to create a single Patch. The *Tone* processes the basic waveforms and forms a part of the Patch. The structure of the Tone is shown below.

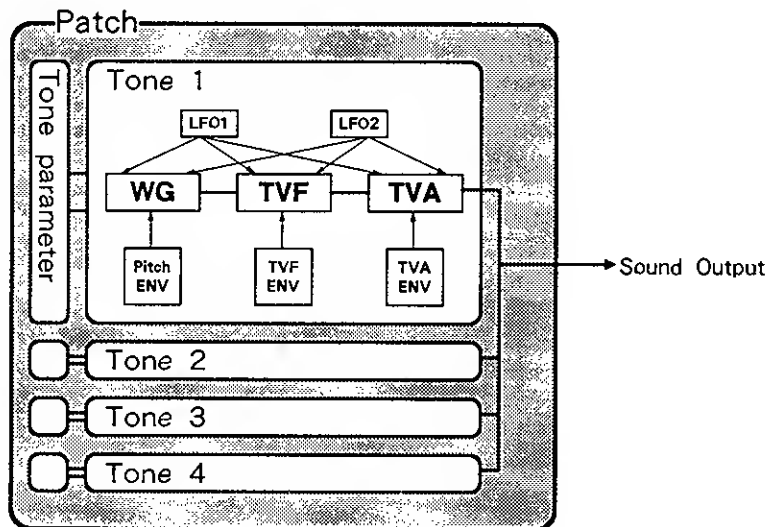

● **WG (Wave Generator)**

This calls up the waveforms stored in internal memory, optional PCM cards or expansion boards, and generates the waveform to be used as the basic sonic building block.

It also controls the pitch of the waveform at the same time. Since it is the basic sound unit, it is crucial in determining the fundamental characteristics of the final sound.

● **TVF (Time Variant Filter)**

This is used to shape the tonal qualities of the sound by processing the original waveform generated by the Wave Generator. It determines the timbre of the sound by cutting or boosting the frequency elements that make up the original waveform.

● **TVA (Time Variant Amplifier)**

This controls the volume of the sound.

● **ENV (Envelope Generator)**

This applies changes in pitch, frequency or volume when used with the WG, TVF and TVA, respectively.

● **LFO**

This applies a periodic and regular change in the pitch, frequency or volume when used with the WG, TVF and TVA, respectively. It adds expression to the sound through various vibrato-like effects.

※ *Patch parameters include the following: the parameters which set the effects for use while Patches are played, the parameters, such as bend range, commonly applied to the Tone contained in the Patch, and the parameters that set the operations of each aspect of the Tone and determine the character of the Tone.*

■ Performances and Patches

By using up to seven Patches (the individual sound programs of the JV-80), and the sound program set for percussion (Rhythm Set), an ensemble of sounds can be created. The group containing these Patches and the Rhythm Set is called a *Performance*. Each Performance is divided into separate sections, called *Parts*, and Patches are assigned to Parts 1—7, with the Rhythm Set assigned to Part 8. By changing the volume balance and the relative pitch among the parts, the total sound of the Performance can be adjusted.

The JV-80 has what are called “*internal zones*” and “*transmit zones*” between the Patches and the internal device (the controllers of the JV-80). The internal zone processes the play data from the internal device and sends them to the Patch. The transmit zone processes the play data from the internal device and sends them through the MIDI OUT terminal. In this way, the eight Parts and instruments controlled over the MIDI channels can be played independently.

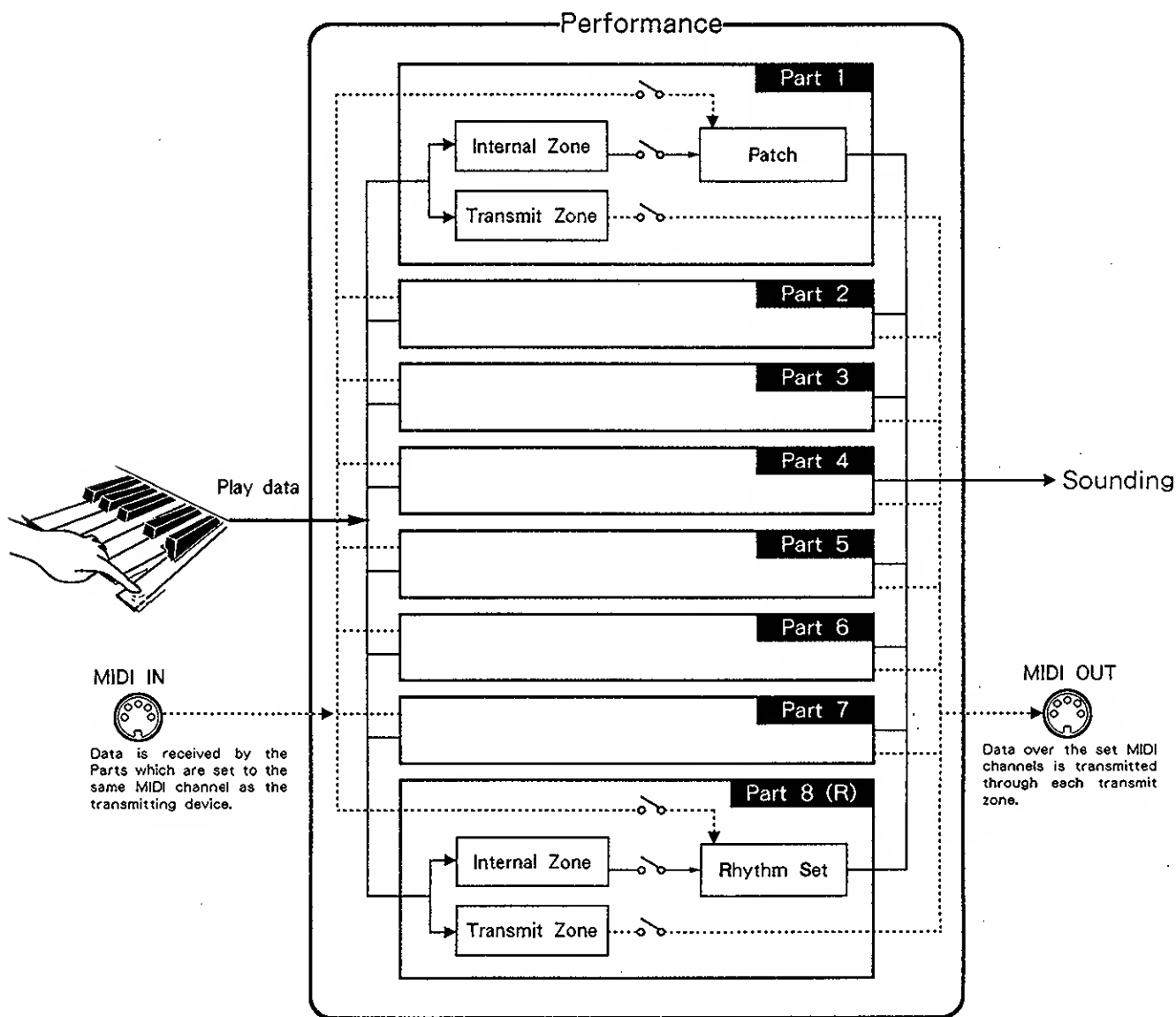

※ The parameters for setting the Parts of the Performance and determining how the sound source responds to the controllers of the JV-80, are called the Performance parameters.

3. SOUND SOURCE AND CONTROLLERS

The JV-80 has a built-in sound source that provides the sonic "building blocks" for the sound. The keyboard and other various controllers (such as the sliders and pedals), are used to control the sound source, resulting in the final sound output. The sound source and the controllers of the JV-80 are shown in the illustration below.

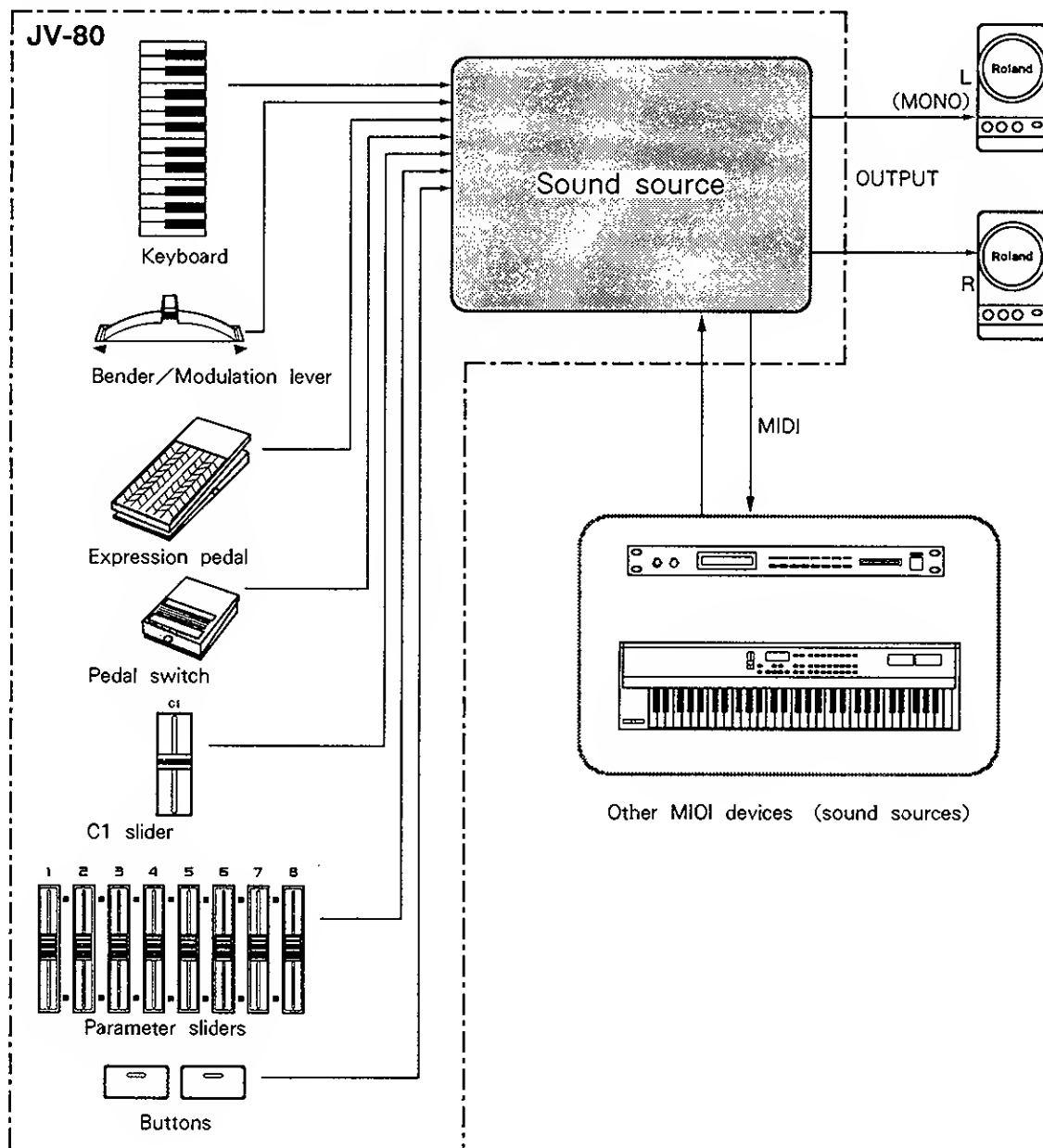

● Keyboard

This is used to play the sounds. It also lets you continuously change the various elements of the sound according to how hard you strike a key (velocity) and how strongly you press down on a key after it has been pressed (aftertouch). Effects such as vibrato and pitch bend can be obtained depending on the settings.

● Bender/Modulation Lever

The pitch alone can be changed by moving the lever laterally (to the right and left). Pressing the lever forward lets you continuously change various aspects of the sound. Generally, this is used to apply effects such as vibrato and tremolo.

● Foot Pedals

Volume, modulation and other parameters can be assigned to pedal control, via the PEDAL 1 and 2 jacks. The JV-80 also has a special jack for controlling the hold (sustain) function.

※ Either expression pedals (Optional: EV-5, EV-10) or pedal switches (Optional: FS-1, DP-2) can be connected to pedal jacks 1 and 2.

● C1 Slider

This slider can be used to control the same functions as the foot pedal, and can change the tonal quality of the sound.

● Parameter Sliders

These are used to adjust various elements of the sound in realtime. You can determine or assign beforehand the parameters you wish to control during performance. The parameters which are controlled by the Parameter Sliders differ from those controlled by the foot pedals and the C1 slider. The Parameter Sliders can also be used to set the parameters when creating or programming sounds.

● Buttons

These are used to turn parameters on and off while playing, or to change the sound programs or modes.

● MIDI

By connecting the JV-80 to other musical instruments that are MIDI-compatible, you can play and control those instruments from the JV-80, or use a connected MIDI device to play and control the sound source of the JV-80. The control data of the keyboard, bender/modulation lever and foot pedals can be transmitted through MIDI.

4. ORGANIZATION OF THE SOUND SOURCE

This section describes the organization of the sound source, so that you can best understand how to use the sound creation and performance functions of the JV-80.

Internal Sound Source

The internal sound source of the JV-80 consists of three sections: memory, in which sound program data is stored, a section of preset sounds, and the effects. The sound program that is selected (either from the panel or remotely by MIDI program change) can be heard when performance (play) data is received from the JV-80 itself or another device connected to the MIDI IN terminal. The sound signals are output through the output terminals or headphone jack after chorus/reverb effects are applied in the effects section.

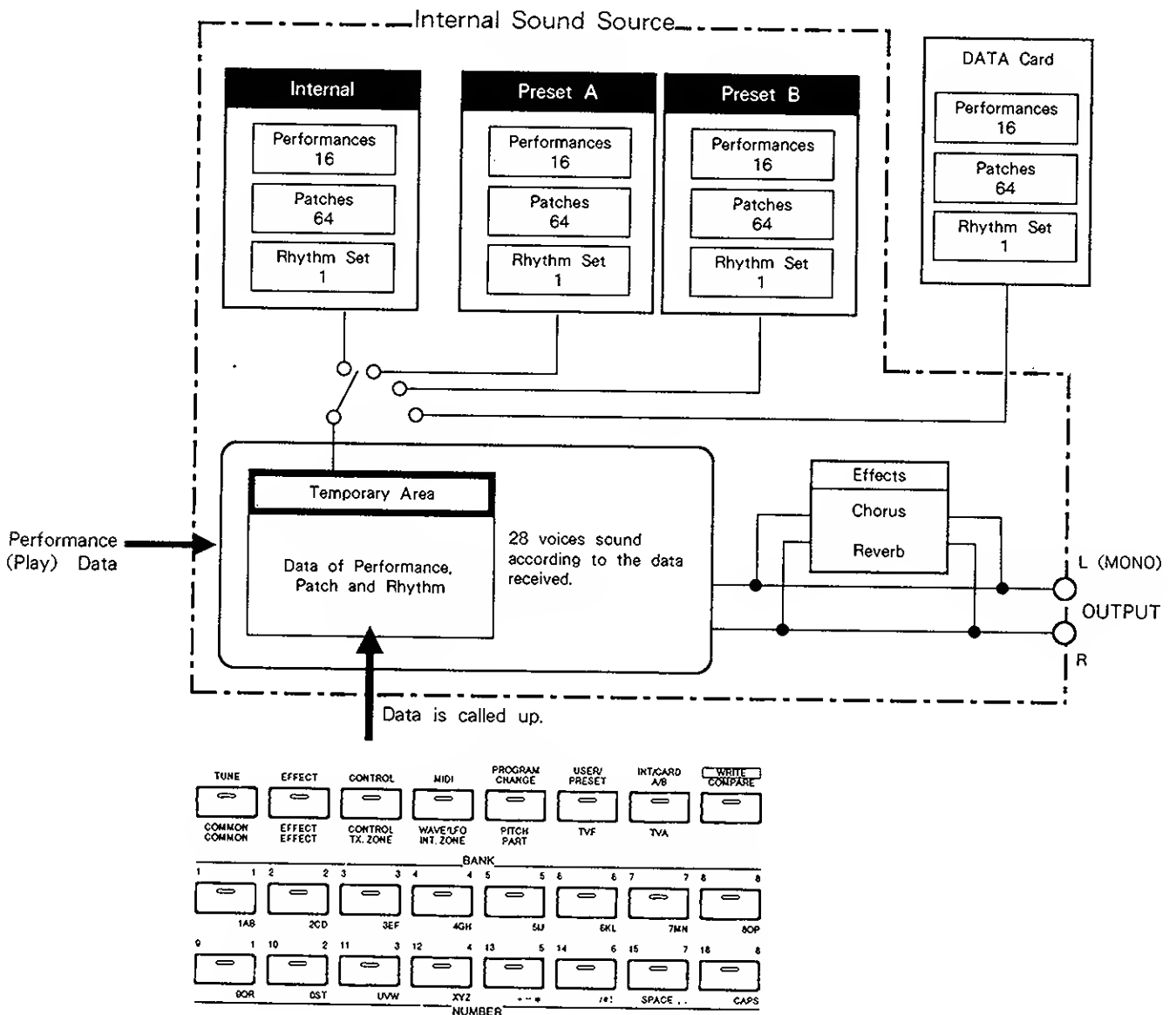

● Memory

The area in which Performances, Patches and other data are stored is called memory. The JV-80 has the following memory types.

◆ User Memory

The internal memory and DATA card (optional) are memory areas that can be used to store original sound program data. Each of the memory areas can store 16 Performances, 64 Patches and 1 Rhythm Set.

◆ Preset A/B

Each of the preset areas A and B contain 16 Performances, 64 Patches and 1 Rhythm Set. The Performance data and the Patch data stored in Preset A/B cannot be overwritten; however, you can use these sound programs as basic material for editing and then store the newly created sounds in User memory.

◆ Temporary Area

This area is used to temporarily store the sound program data. Performance data and Patch data are read in from User memory or Preset A/B by panel button operations or MIDI messages. (You can think of the temporary area as a place where a copy of the data is kept. The internal sound source sounds according to the data in the temporary area. Since any adjustments and editing of the data is done strictly in the temporary area, the original data will not be changed or lost.)

● Sound Source Section

The sound source section of the JV-80 can play up to 28 sounds simultaneously. This is the maximum number of voices, or its polyphonic capacity.

● Effects

Stereo chorus and reverb effects are built into the JV-80, and they can be used simultaneously.

SECTION 3

PLAY

SECTION 3

1. PLAYING PATCHES

What is the Patch Play mode?

In the Patch Play mode, a single Patch is called up to the temporary area from where it can be played. A Patch consists of a maximum of four Tones, and the parameters of each Tone are controlled by Parameter Sliders 1—4 or the **TONE SWITCH** buttons (1—4). However, since the data which is called up to the temporary area is used when a Performance is selected, the original Patch in the internal memory or DATA card will be retained. The data being used in the temporary area can be stored as a new Performance in the user memory. (See Command Section, Write Mode)

Since the Patch Play mode allows you to control each Tone of the Patch and fully utilize the expressive capabilities of one sound program, it adds a new dimension to the playing of lead lines and lets you create sounds that were previously not possible.

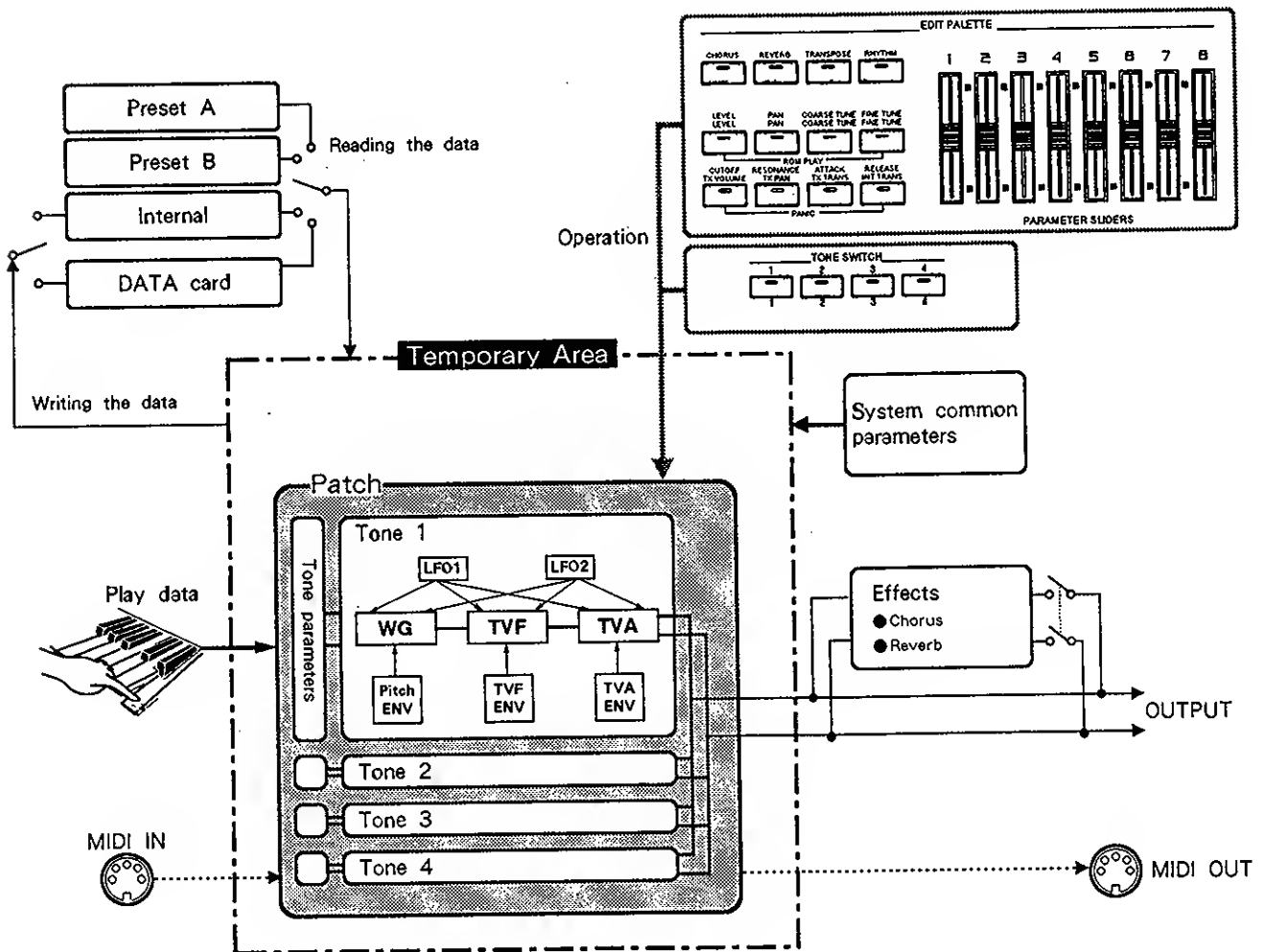

The assign buttons (P.34) are used to call up the parameters which correspond to the basic sound elements of a Tone (pitch of the sound, frequency elements, volume, changes over time, and effects). These are the standard values for how the sound changes according to time, key range, and key velocity. Using the ▲ and ▼ buttons, you select the parameters which determine how such changes are made.

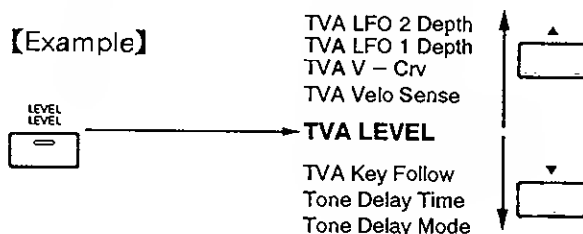

Parameters Available for Realtime Control

The parameters which can be controlled while you are playing are divided into the categories shown below.

● Pitch-related Parameters

★ Coarse Tune

This changes the pitch in half-tone units. By changing this pitch parameter, you can change the sound program. You can change the quality of the sound by shifting the pitch in octave units, or by changing the sound range of a single Tone within one sound program.

★ Fine Tune

This lets you make fine changes in the pitch. It is used to create a detuning effect or make the sound thicker. For example, you can use it to reproduce a honky-tonk piano sound by slightly changing the pitch between the Tones of two piano sounds.

● Timbre-related Parameters

★ Cutoff

This changes the cutoff frequency of the TVF. It is useful for creating dynamic changes in the brightness of the sound. It can also, completely change the timbre of the sound by altering the brightness of each Tone. A growling effect can be created by moving the Parameter Slider slightly back and forth.

★ Resonance

This creates a characteristic sound by emphasizing the frequency elements around the cutoff frequency of the TVF.

● Volume-related Parameters

★ Level

This lets you adjust the volume of the sound. When a Patch consists of several Tones, the character of the Patch as a whole can be altered by changing the relative volume balance of the Tones. For example, when the attack and decay portions of a sound are made up of separate Tones, the quality of the attack and decay portions are altered according to the Tone whose level is changed.

● Parameters related to changing the sound over time

- ★ These allow you to adjust the change in the sound over time by controlling the *envelopes applied to the wave generator, TVF and TVA*. By shortening the attack time, you can emphasize the attack portion of the sound. By controlling the *Envelope Level L3*, you can make dynamic changes in the brightness and "thickness" of the decay or sustain portion of the sound.

● Stereo Position and Effect Parameters

★ Pan and Effects

This lets you create a sense of space and movement by changing the stereo position of each Tone. For example, you can create the effect of a player moving around the stage by continuously changing the stereo position of a solo instrument sound program. Three-dimensional effects, such as placement of sounds in the foreground or echo can also be obtained by adjusting the level of the JV-80's built-in effects.

In addition to the basic parameters explained above, there are parameters which allow you to change the sound according to how hard you play the keys or what range of the keyboard you play. With the use of these parameters, you can eliminate harsh high-frequency elements in a Tone, or have an otherwise silent Tone sound when you play the keys strongly.

- ※ Both the MIDI send and receive channels can be set in the Patch Play mode as well. However, since this setting is determined not by the Patch parameters but by the system common parameters, the MIDI channel will not change even though the Patches are changed. Because of this, the MIDI channels must be set with the system common parameters (P.75).

In the Patch Play mode, one parameter controls four Tones. However, in the Patch Edit mode (P.78), which will be explained later, several parameters for one Tone are called up to the display. Because of this, it is occasionally difficult to see the entire structure of the Patch. Therefore, it is effective to use the Patch Play mode in order to edit the Patch, keeping the balance among the Tones.

■ Operation

This section how to select Patches, how to select the LCDs (pages) in which the parameters are shown, and how to adjust and set the displayed parameters.

● Selecting the Patch Play Mode

Press the **PATCH PLAY** button to enter this mode.

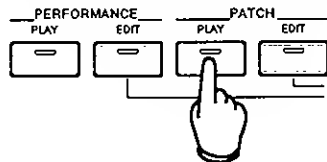

● Changing Patches

Press the **USER/PRESET** button to switch between User memory and Preset (A/B). (The indicator of the button lights when Preset is selected.)

When User memory is selected, pressing the **INT/CARD A/B** button switches between Internal and DATA card. When Preset is selected, pressing the **INT/CARD A/B** button switches between (group) A and B. (The indicator of the button lights when the DATA card or Preset B is selected.)

- ※ If the DATA card has not been properly inserted into the DATA CARD slot, the DATA card Patches cannot be selected, even when **INT/CARD A/B** is pressed.

Change the bank by pressing **BANK**, and change the number by pressing **NUMBER**. (The numbers 1 — 8 printed in *orange* indicate banks and numbers.)

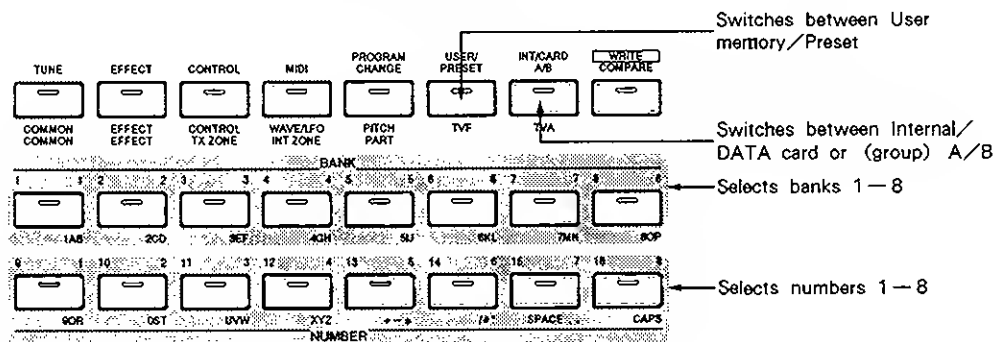

● Inserting DATA Cards





With the label side up, gently (but firmly) insert the DATA card into the DATA CARD slot on the rear panel. The DATA card has a special protect switch used to prevent accidental erasure of data stored in the card. Always make sure the Protect switch is On when inserting or removing the DATA card.



※ Use the optional M-256E for the DATA card.

■ Operation

● **Selecting and Adjusting the Patch Parameters with the Assign Buttons**

Pressing one of the *assign buttons* directly calls up the Patch parameter corresponding to that button. (The letters printed in orange above the assign buttons indicate the Patch parameters.)

Once a parameter has been selected, a “” or “” mark is shown in the display, indicating that other display pages (showing additional parameters) can be selected. In this case, the display can be changed by pressing the  and  buttons.

One display of the several available displays is called a “page.” To switch (to move to another display) by pressing the  and  buttons is referred to as “selecting pages.”

【Example】

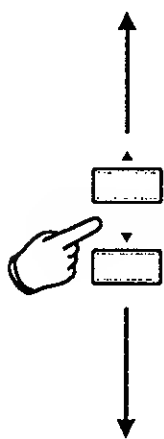

PATCH I11	#JV Strings	:	TVA LFD 2 Depth
	# 01		01 +631 -63
PATCH	#JV Strings	:	TVA LFD 1 Depth
PATCH	#JV Strings	:	TVA V-Crv T1=3_/_
PATCH	#JV Strings	:	TVA Velo Sense
PATCH I11	#JV Strings	:	TVA Level
	# 1271		1271 1271 127
PATCH	#JV Strings	:	TVA Key Follow
PATCH	#JV Strings	:	Tone Delay Time
PATCH I11	#JV Strings	:	Tone Delay Mode
	# NORMAL		NORMAL HOLD PLAY

The value for the selected parameter of each individual Part is adjusted by using the appropriate *Parameter Slider* (1—4). Each number of the four numbers in the display indicates the parameter value of each Tone, in order from left to right. The number printed above each slider indicates the Tone which can be operated by the slider.

EDIT PALETTE

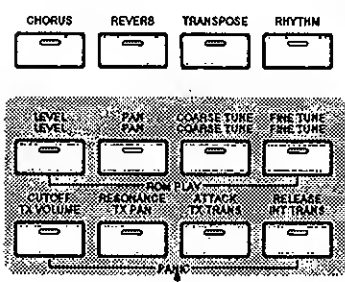

Assign buttons
(For selecting the parameters)

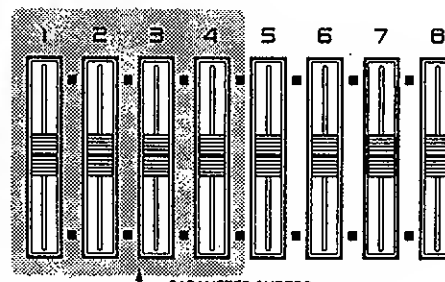

PARAMETER SLIDERS
For adjusting the parameter value

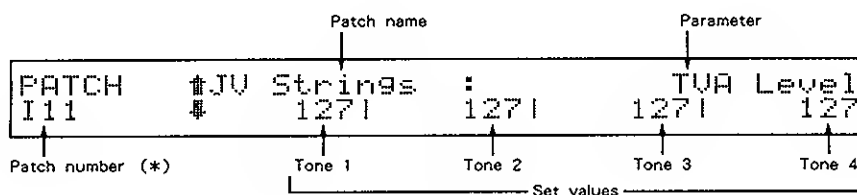

(*) : I = internal, C = DATA card, A or B = preset (group)

● Adjusting the settings with the **DEC** / **INC** buttons

You can also correct or adjust the parameter values by using the **DEC** / **INC** buttons. Move the *CURSOR* to the Part to be changed using the **◀** / **▶** buttons, and press the **INC** button to increase the value or the **DEC** button to decrease the value.

※ Holding down either the **DEC** / **INC**, **◀** / **▶** or **▲** / **▼** button steps continuously through the values (*auto repeat function*).

You can move through the values faster by holding down one of the two buttons and pressing the other.

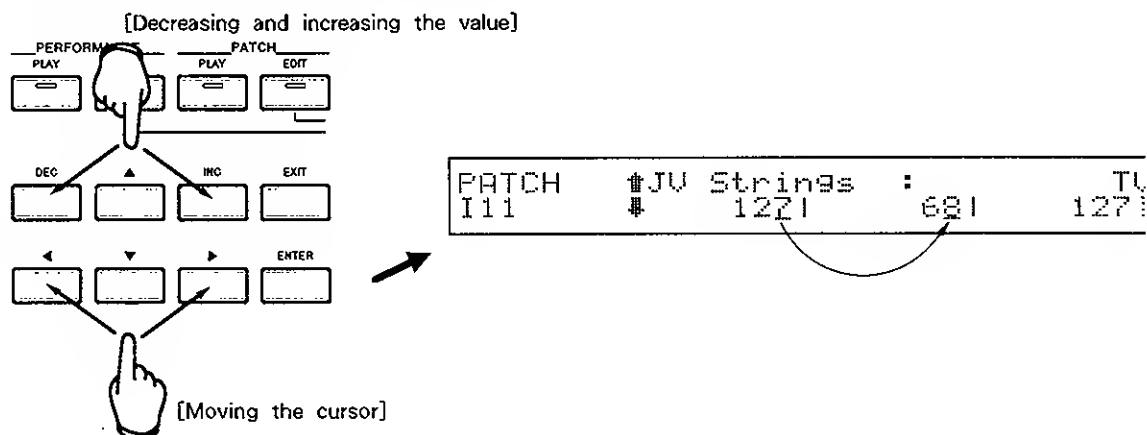

● How to use the **TONE SWITCH**

When used during play of a Patch, the **TONE SWITCH** buttons (1 — 4) function as on/off switches for the sound of the Tones. They can be conveniently used to check the sound of each component Tone in a Patch.

※ The indicator of the button lights when set to ON.

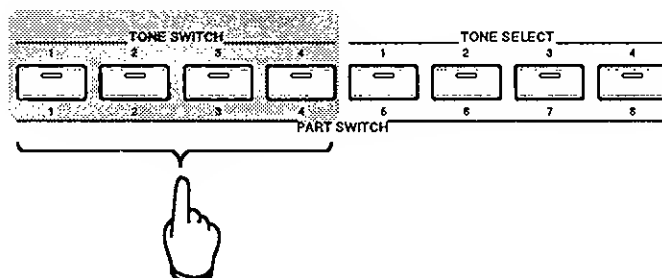

LEVEL

■ Explanations of the Parameters

This section explains the Patch parameters adjusted in the Patch Play mode for each assign button.

The parameters which are displayed when the assign button is pressed are explained first, followed by explanations of the parameters that are selected by **▲**/**▼**, in the order they are selected.

LEVEL

TVA Level TVA Level Range: 0 — 127

This determines the level (volume) of each Tone. The maximum is 127.

PATCH	#JU Strings	:	TVA Level
I11	# 127	100	68

The display selected by **▲** (4 pages)

TVA Velo Sense TVA Velocity Sensitivity Range: - 63 — +63

This determines how sensitive the level of each Tone is to the velocity.

PATCH	#JU Strings	:	TVA Velo Sense
I11	# +32	+32	0

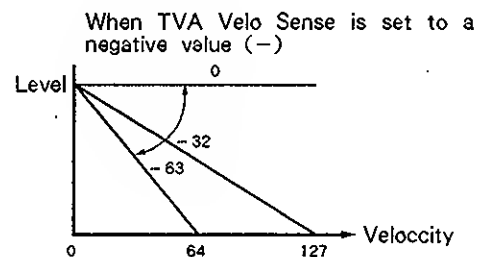
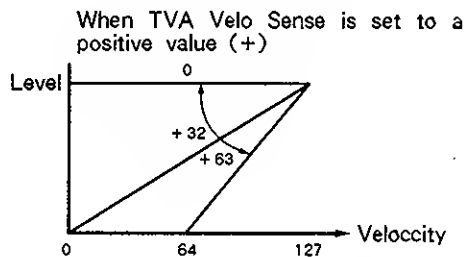

TVA V-Crv TVA Velocity Curve Type Range: 1 — 7

This determines how the level of each Tone changes in response to the playing velocity, according to the specified curve. The mark shown at the top right of the LCD indicates the shape of the curve.

PATCH	#JU Strings	:	TVA V-Crv	T1=3
I11	# 31	1	1	5

Velocity curves

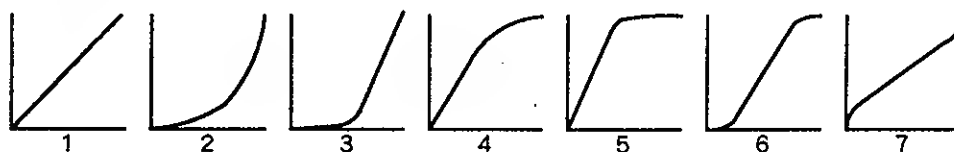

TVA LFO 1 Depth TVA LFO 1 Depth Range: - 63 — +63

TVA LFO 2 Depth TVA LFO 2 Depth Range: - 63 — +63

These two pages are used to set the depth of LFO 1 and 2 applied to the TVA level of each Tone. The larger the value, the greater the change of the level. The level changes direction depending on whether the value is positive (+) or negative (-).

```
PATCH  #JV Strings : TVA LFO 1 Depth
I11    #    +101  -101  +251  -25
```

```
PATCH  #JV Strings : TVA LFO 2 Depth
I11    #    +51   01   -51  -10
```

The display selected by ▼ (3 pages)

TVA Key Follow TVA Level Key Follow

Settings: - 100/ -70/ -50/ -40/ -30/ -20/ -10/0/+10/+20/+30/+40/+50/+70/+100

This determines how the level changes in response to the key range played. With the C4 key as a standard of reference, when the value is positive (+), the higher the key played, the greater the level. When the value is negative (-), the lower the key played, the greater the level. The farther the value is set from 0, the greater the change (increase or decrease) becomes for both positive and negative values.

```
PATCH  #JV Strings : TVA Key Follow
I11    #    +201   01  -201  -40
```

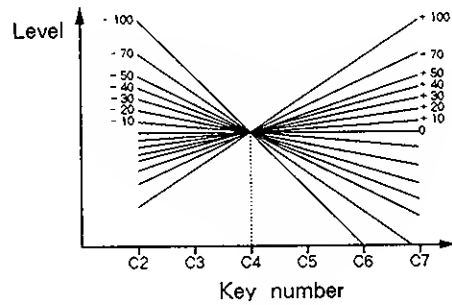

Tone Delay Time Tone Delay Time Range: 0 — 127/KEY-OFF

This determines the time that elapses from note on (playing of a key) until each Tone starts to sound. The greater the value, the longer the time. When set to KEY-OFF, the sound starts only after the key is released (note off).

```
PATCH  #JV Strings : Tone Delay Time
I11    #    01    01   40|KEY-OFF
```

LEVEL

Tone Delay Mode *Tone Delay Mode* Settings: NORM/HOLD/PLAY

This determines the type of delay applied to each Tone.

NORM simply delays the sound, and is effective even after the note is released (note off). When HOLD is selected, the Tone will not sound if the note is released before the delay time has elapsed. The PLAY (PLAYMATE) setting monitors the keyboard in applying the delay; the time from the first note on to the second note on becomes the delay time. (However, the Tone to be delayed will not sound if more than two seconds separate the two notes on.) When the Tone Delay Time is set to KEY-OFF, the instrument sounds when the key is released, regardless of the settings made here.

```
PATCH  ↑JV Strings : Tone Delay Mode
I11    █ NORMAL █ NORMAL █ HOLD █ PLAY
```

NORM

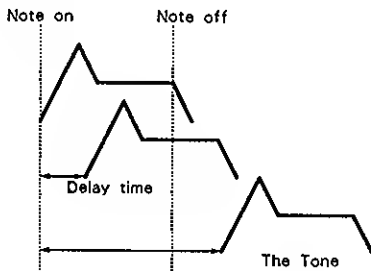

HOLD

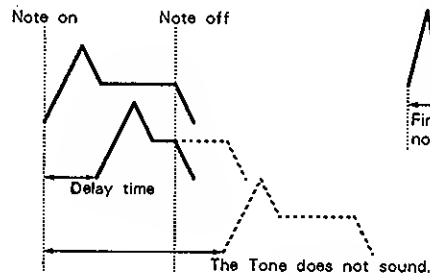

PLAY(PLAYMATE)

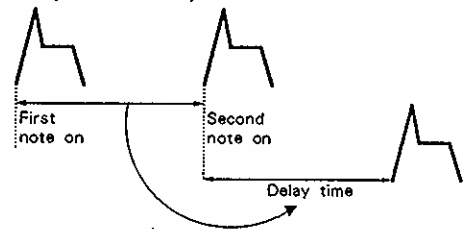

The delay time changes depending on the time difference between the first note on and the second note on.

PAN

Pan *Pan* Range: L64 — 0 — 63R/RND

This determines the stereo position of each Tone. The sound position is at the farthest left at L64, at the center at 0, and at the farthest right at 63R. When set to RND, the position changes randomly with each note played.

PATCH	↑JV Strings	:		Pan
I11	↓ 63R1	:	0 1	RND
			L631	

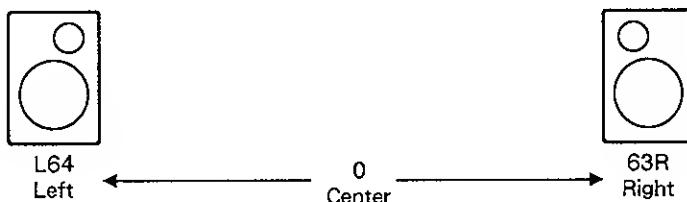

The display selected by **▲** (3 pages)

Dry level *Dry Level* Range: 0 — 127

This determines the level of the unprocessed (dry) sound (the signal to which no effect has been applied).

PATCH	↑JV Strings	:		Dry Level
I11	↓ 1271	:	1001	1001 96

Chorus Send *Chorus Send Level* Range: 0 — 127

This determines the level of the signal to be sent to the chorus processor.

PATCH	↑JV Strings	:		Chorus Send
I11	↓ 101	:	851	1001 100

Reverb Send *Reverb Send Level* Range: 0 — 127

This determines the level of the signal to be sent to the reverb processor.

PATCH	↑JV Strings	:		Reverb Send
I11	↓ 1271	:	1001	01 0

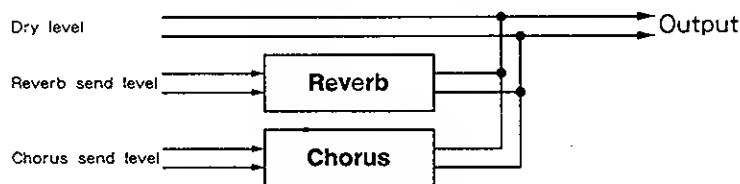

※ When using the chorus or reverb effects, press **CHORUS** or **REVERB** on the panel beforehand in order to turn on the appropriate effect.

PAN

The display selected by (1 page)

Pan Key Follow *Pan Key Follow*

Settings : -100/ -70/ -50/ -40/ -30/ -20/ -10/0/+10/+20/+30/+40/+50/+70/+100

This determines changes in the stereo image position of the sound according to the key range played. With the C4 key as a standard of reference, when the value is positive (+), higher keys played sound to the right of center. When the value is negative (-), lower keys played sound to the right of center. The farther the value is set from 0, the further the sound is placed toward the extreme pan positions.

```
PATCH   ↑JU Strings   :   Pan Key Follow
I11     ↓           01  +100|   -100|   0
```

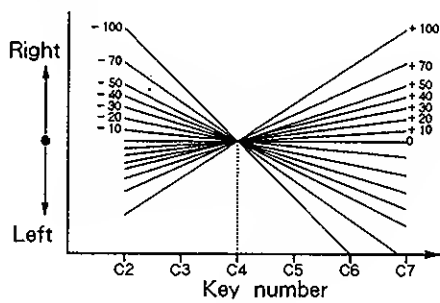

COARSE TUNE

COARSE TUNE

Coarse Tune *Coarse Tune* Range: - 48 — +48

This determines the pitch of the sound in semitone units. The greater the value, the higher the pitch.

PATCH	#JU	Strings	:	Coarse Tune
I11	#	01	01	+121 -12

The display selected by  (3 pages)

Pitch Envelope *Pitch Envelope Depth* Range: - 12 — +12

This determines the overall depth of the pitch envelope.

When the value is positive (+), the greater the depth of the envelope and the higher the pitch. When the value is negative (-), the greater the depth of the envelope and the lower the pitch. The farther the value is set from 0, the greater the pitch change becomes for both positive and negative values.

PATCH	#JU	Strings	:	Pitch Envelope
I11	#	01	01	+121 -12

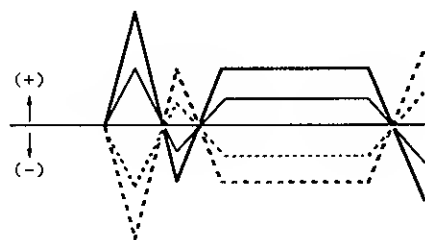

Pitch LFO1 Depth *Pitch LFO1 Depth* Range: - 63 — +63

Pitch LFO2 Depth *Pitch LFO2 Depth* Range: - 63 — +63

In these two pages, these parameters determine the depth of LFOs 1 and 2 that are applied to the pitch of each Tone. The greater the value, the greater the variation in pitch. Setting the parameter to either positive or negative values reverses the direction of the pitch change.

PATCH	#JU	Strings	:	Pitch LFO 1 Depth
I11	#	01	01	+501 -50

PATCH	#JU	Strings	:	Pitch LFO 2 Depth
I11	#	01	01	-101 -20

COARSE TUNE

The display selected by (1 page)

Pitch Key Follow *Pitch Key Follow*

Settings: -100/-70/-50/-30/-10/0/+10/+20/+30/+40/+50/+70/+100/+120/+150/+200

This determines how the pitch of each Tone changes in response to the key range played. With the C4 key as a standard of reference, when the value is positive (+), the higher the key played, the higher the pitch. When the value is negative (-), the lower the key played, the higher the pitch. The farther the value is set from 0, the greater the change (increase or decrease) becomes for both positive and negative values.

```

PATCH  ↑JV Strings  : Pitch Key Follow
I11     █          01  +100|  +100|  +100
    
```

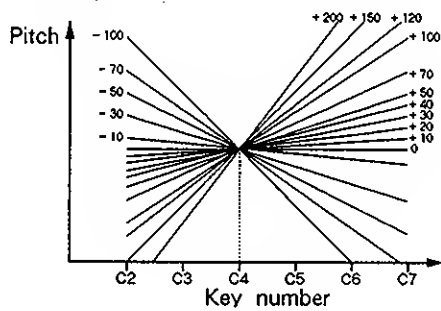

FINE TUNE

Fine Tune *Fine Tune* Range: - 50 — +50

This determines the fine pitch setting of each Tone, adjustable in units of 1/100 of a semitone. When this is set to a positive value (+), the greater the value, the higher the pitch. When negative (-), the greater the value, the lower the pitch.

PATCH	#JU	Strings	:	Fine Tune
I11	#	+51	:	-51 -10

The display selected by (1 page)

Random Pitch *Random Pitch*

Settings : 0/5/10/20/30/40/50/70/100/200/300/400/500/600/800/1200

This determines the range over which the pitch of each Tone is randomly shifted upon note on (every time a key is played). The increments are 1/100 of a semitone. At a setting of 100, the pitch is shifted randomly (up or down) within a semitone range.

PATCH	#JU	Strings	:	Random Pitch
I11	#	01	:	101 20

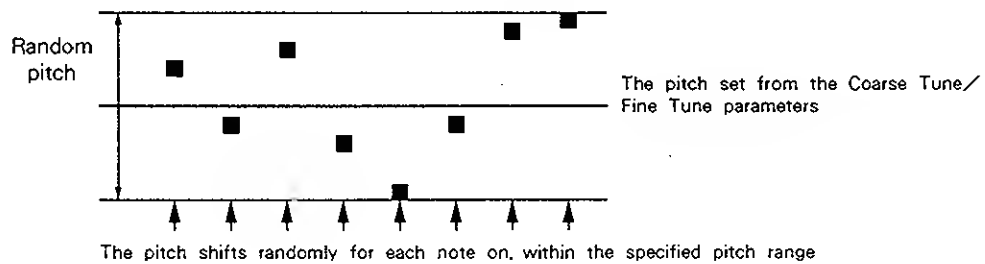

CUTOFF

CUTOFF

Cutoff TVF Cutoff Range: 0 — 127

This determines the cutoff frequency of the TVF of each Tone. The greater the value, the higher the cutoff frequency.

PATCH	↑JU Strings	:	Cutoff
I11	↓ 127	100	80

The display selected by **▲** (4 pages)

TVF Envelope TVF Envelope Depth Range: - 63 — +63

This determines the overall depth of the TVF envelope of each Tone. When the value is positive (+), the greater the depth of the envelope, the higher the cutoff frequency.

When the value is negative (-), the greater the depth of the envelope, the lower the cutoff frequency. The farther the value is set from 0, the greater the effect becomes for both positive and negative values.

PATCH	↑JU Strings	:	TVF Envelope
I11	↓ +54	0	+18

Envelope depth

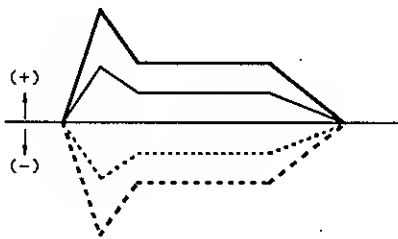

TVF-Env Velo Sense TVF Velocity Envelope Level Sensitivity Range: - 63 — +63

This determines how the TVF envelope of each Tone responds overall to key velocity. When the value is positive (+), the stronger the velocity, the higher the cutoff frequency. When the value is negative (-), the stronger the velocity, the lower the cutoff frequency.

The farther the value is set from 0, the greater the effect becomes for both positive and negative values.

PATCH	↑JU Strings	:	TVF-Env Velo Sense
I11	↓ 0	0	0

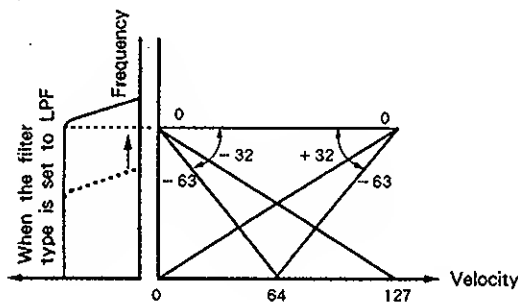

CUTOFF

TVF LFO 1 Depth TVF LFO1 Depth Range: - 63 — +63

TVF LFO 2 Depth TVF LFO2 Depth Range: - 63 — +63

In these two pages, these parameters determine the depth of LFOs 1 and 2 that are applied to the TVF cutoff frequency. The greater the value, the greater the variation in the cutoff frequency. Setting the parameter to either positive or negative values reverses the direction of the cutoff frequency change.

PATCH	↑JV Strings	:	TVF LFO 1 Depth
I11	↓	01	+63 -63

PATCH	↑JV Strings	:	TVF LFO 2 Depth
I11	↓	01	+63 -63

The display selected by ▼ (2 pages)

Filter Type Filter Type Settings: OFF/LPF/HPF

This determines the type of TVF for each Tone. The LPF (low pass filter) setting allows the low elements of the frequency to pass unfiltered. The HPF (high pass filter) setting allows the high elements of the frequency to pass unfiltered. The filter does not function when set to OFF.

PATCH	↑JV Strings	:	Filter Type
I11	↓	LPF1	HPF1 OFF

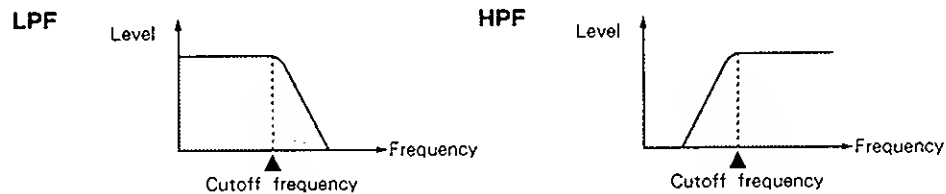

Cutoff Key Follow Cutoff Key Follow

Settings: - 100/ -70/ -50/ -30/ -10/0/+10/+20/+30/+40/+50/+70/+100/+120/+150/+200

This determines how the TVF cutoff frequency of each Tone changes in response to the key range played. With the C4 key as a standard of reference, when the value is positive (+), the higher the key played, the higher the cutoff frequency. When the value is negative (-), the lower the key played, the higher the cutoff frequency. The farther the value is set from 0, the greater the change (increase or decrease) of the cutoff frequency becomes for both positive and negative values.

PATCH	↑JV Strings	:	Cutoff Key Follow
I11	↓	01	+50 -50

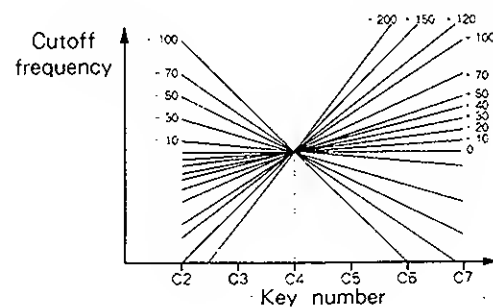

RESONANCE

RESONANCE

Resonance TVF Resonance Range: 0—127

This determines the strength of the resonance effect applied to the TVF of each Tone. The greater the value, the stronger the resonance effect.

PATCH	#JV	Strings	:	Resonance
I11	#	01	501	701 0

The display selected by (1 page)

Resonance Mode Resonance Mode Settings: HARD/SOFT

This switches between strong and moderate resonance. The resonance effect becomes stronger when set to HARD, and becomes less pronounced when set to SOFT.

PATCH	#JV	Strings	:	Resonance Mode
I11	#	SOFT1	SOFT1	HARD1 SOFT

The parameters called up by the **ATTACK** / **RELEASE** buttons

By using these two buttons, the parameters related to the envelopes of both the TVF and TVA of each Tone are called up. *The parameters are the same, but the first page and the order of the pages differs between the TVF parameters and TVA parameters (see illustration below).*

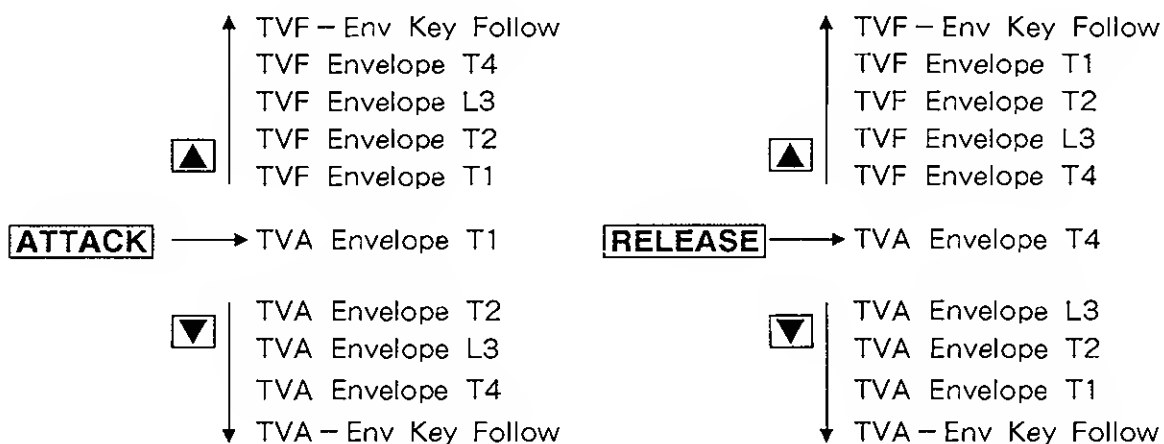

In the following five display pages, the change of the cutoff frequency over time (TVF envelope) can be controlled.

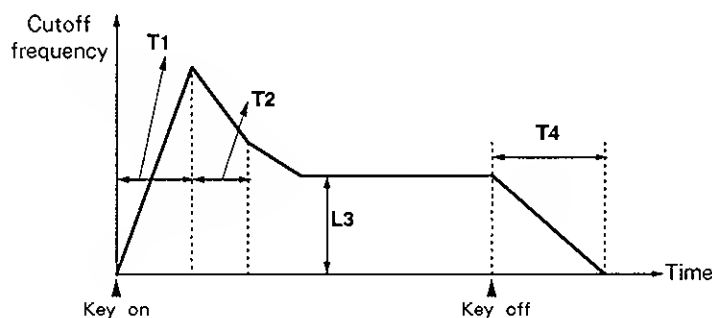

TVF Envelope T1 TVF Envelope T1 Range: 0 — 127

This determines T1 of the TVF envelope. The greater the value, the longer the time of T1, allowing you to make the sound gradually become brighter as it decays.

```

PATCH  #JV Strings : TVF Envelope T1
I11    #      01    101    251    80
    
```

ATTACK / **RELEASE**

TVF Envelope T2 *TVF Envelope T2* Range: 0 — 127

This determines T2 of the TVF envelope. The greater the value, the longer the time of T2, allowing you to make the timbre of the sound gradually become softer as it decays.

PATCH	↑JV	Strings	:	TVF Envelope T2
I11	↓	351		201 351 70

TVF Envelope L3 *TVF Envelope L3* Range: 0 — 127

This determines L3 of the TVF envelope. The greater the value, the brighter the sustained portion of the sound.

PATCH	↑JV	Strings	:	TVF Envelope L3
I11	↓	1001		401 801 95

TVF Envelope T4 *TVF Envelope T4* Range: 0 — 127

This determines T4 of the TVF envelope. The greater the value, the longer the time of T4, allowing you to make the timbre of the sound change gradually after the key is released.

PATCH	↑JV	Strings	:	TVF Envelope T4
I11	↓	101		251 251 50

TVF-Env Key Follow *TVF Envelope Time Key Follow*

Settings : -100/ -70/ -50/ -40/ -30/ -20/ -10/0/+10/+20/+30/+40/+50/+70/+100

This determines how the TVF envelope changes in response to the key range played. With the C4 key as a standard of reference, when the value is positive (+), the higher the key played, the shorter the overall time of the envelope, and the less time it takes to reach successive level values within the envelope. When the value is negative (-), the lower the key played, the shorter the overall time of the envelope, and the less time it takes to reach successive level values within the envelope.

PATCH	↑JV	Strings	:	TVF-Env Key Follow
I11	↓	+501		+201 01 -20

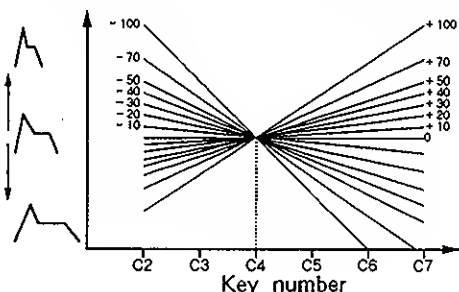

ATTACK / **RELEASE**

In the following five display pages, the change of the sound level over time (TVA envelope) can be controlled.

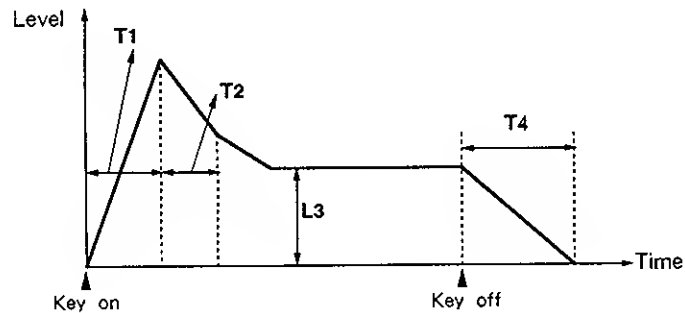

TVA Envelope T1 TVA Envelope T1 Range: 0—127

This determines T1 of the TVA envelope. The greater the value, the longer the time of T1, allowing you to make the sound start slowly.

```
PATCH  #JU Strings : TVA Envelope T1
I11    #      51   51      201    60
```

TVA Envelope T2 TVA Envelope T2 Range: 0—127

This determines T2 of the TVA envelope. The greater the value, the longer the time of T2, which makes the decay of the sound slower.

```
PATCH  #JU Strings : TVA Envelope T2
I11    #      101  201    451    90
```

TVA Envelope L3 TVA Envelope L3 Range: 0—127

This determines L3 of the TVA envelope. The greater the value, the higher the level of the sustained portion of the sound.

```
PATCH  #JU Strings : TVA Envelope L3
I11    #      1001  851    851    0
```

TVA Envelope T4 TVA Envelope T4 Range: 0—127

This determines T4 of the TVA envelope. The greater the value, the longer the time of T4, allowing you to have sounds linger on after the key is released.

```
PATCH  #JU Strings : TVA Envelope T4
I11    #      151  301    301    60
```

ATTACK / **RELEASE**

TVA - Env Key Follow *TVA Envelope Time Key Follow*

Settings : -100/ -70/ -50/ -40/ -30/ -20/ -10/0/+10/+20/+30/+40/+50/+70/+100

This determines how the TVA envelope changes in response to the key range played. When the value is positive (+), the higher the key played, the shorter the overall time of the envelope, and the less time it takes to reach successive level values within the envelope. When the value is negative (-), the lower the key played, the shorter the overall time of the envelope, and the less time it takes to reach successive level values within the envelope.

PATCH	#JU Strings	:TVA-Env	Key Follow
I11	50	+20	0 -20

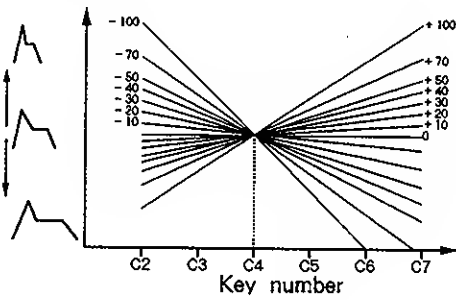

2. PLAYING A PERFORMANCE

What is the Performance Play mode?

When you play the JV-80 in the Performance Play mode, the performance data controls the Patches through the internal zone, and external MIDI data is controlled through the transmit zone.

The internal device (the controllers of the JV-80), such as the keyboard, controls the Patches assigned to each Part for the internal sound source, and also serves as a master keyboard which controls play data over eight MIDI channels through the transmit zone for the external device (MIDI). You can also change the sound of Patches assigned to the Parts according to how you play. Do this by setting the parameters of the Parts and internal/transmit zones, matching to the song and performance condition. Since data which is called up to the temporary memory area is used when a Performance is selected, the original Performance in the internal memory or DATA card will be retained. The data being used in the temporary area can be stored as a new Performance in the user memory. (See Command Section, Write Mode.)

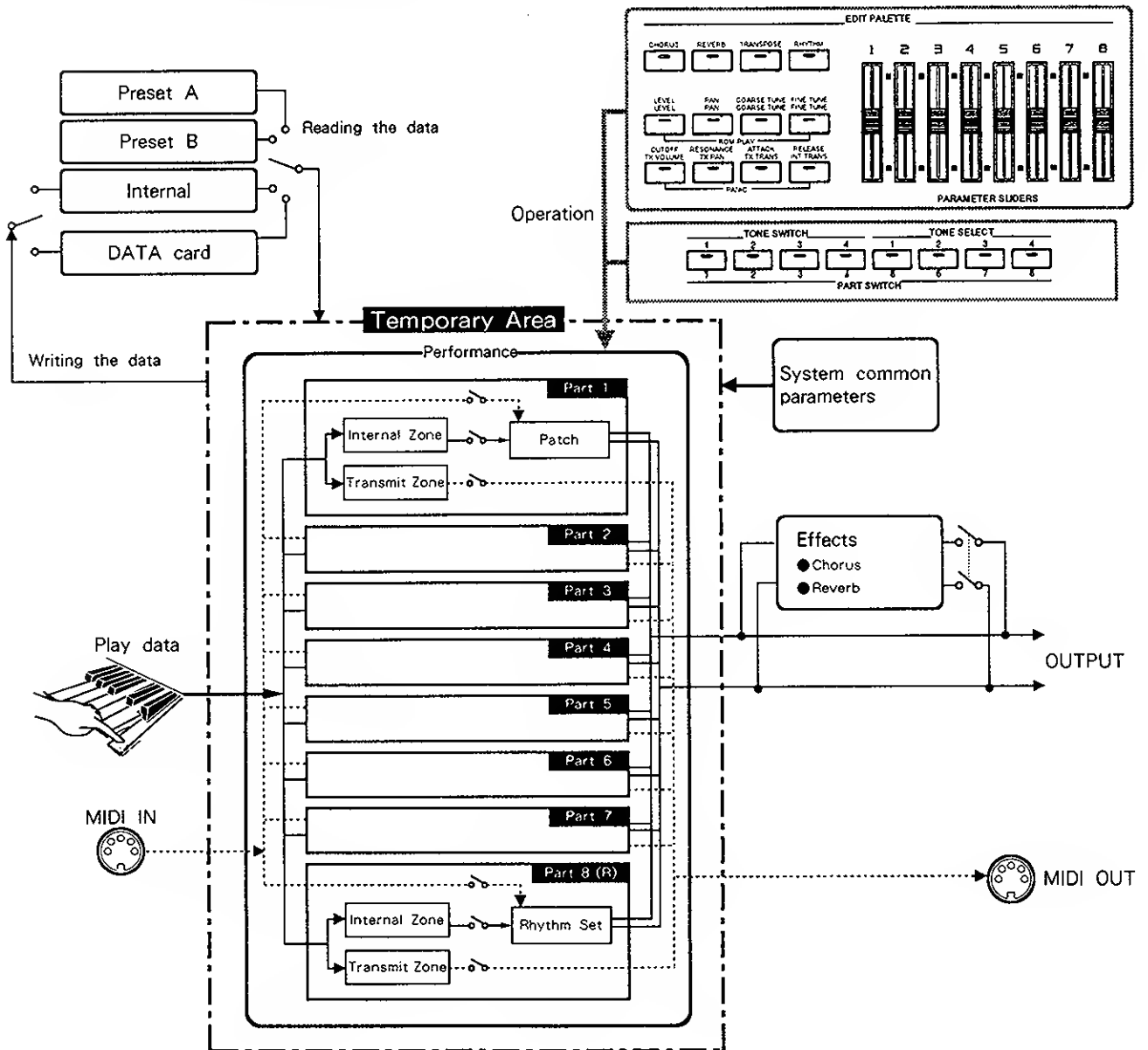

Parameters Available for Realtime Control

The parameters which can be controlled while you are playing in the Performance Play mode are roughly divided into three categories.

● Part Parameters

These are parameters which are related to the overall sound, such as the volume and the fixed stereo position of the Part. They are not parameters of the Patch itself, but are parameters of a Part that apply relative changes to settings such as level, pan and pitch, which are already set for the Patch.

- ★ By controlling the *volume* for each Part, you can mix the sounds just as you would with an eight-channel mixer. It is possible to adjust the dynamic balance of the sounds by increasing the level of the Part which plays the melody or rhythm, for example. You can also finely adjust the relative levels of all the Parts to create a well-balanced ensemble sound. The function can also be used for fading Parts in and out or for muting them.
- ★ The sound image moves left and right when the *pan* function is operated. This is particularly effective for lead lines, or in creating a sense of space by sweeping effect sounds to the left and right.

Assign the placement of the sound of each Part by setting the level and the pan.

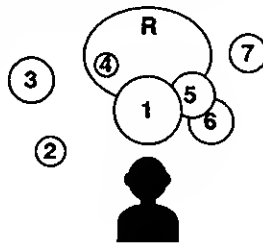

- ★ There are two *pitch-related* functions. One changes the pitch in units of a semitone (*Coarse Tune*) and the other changes the pitch in units of 1/100 of a semitone (*Fine Tune*). These can be used to temporarily change the tuning or to adjust the pitch of the selected Patch relative to the other Parts. They can be also used to create a chorus effect by changing the pitch continuously, or to make special effect sounds. You can even use this instead of the pitch bender, by adjusting the Fine Tune control as you play.

Retuning Patches to keep them all at the same pitch

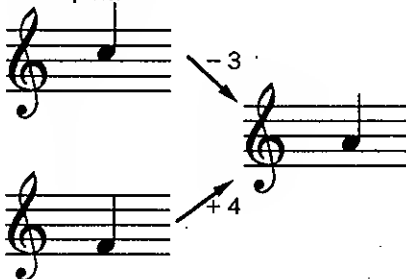

Making one Patch sound at different pitches

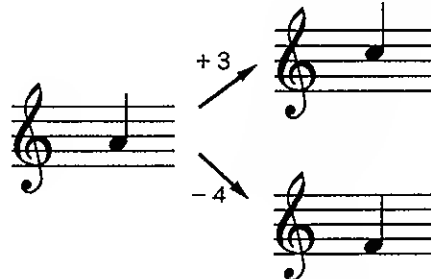

- ※ We suggest that you use the above method to change the pitch of the sound, instead of using the transpose function which will be explained later.
- ※ In situations when you have to change the overall pitch of the JV-80 to match the tuning of other instruments, set the *Tune parameter of the system common parameters*.

- ★ The *MIDI receive channel* is a Part parameter. When using another keyboard to play the sound source of the JV-80, the JV-80 can easily be matched to the transmission channel(s). This is especially convenient for checking which MIDI data is being transmitted over which channel. Also, by combining this function with Patch selection (the explanation of which follows), a sound program can be assigned to performance data which was intended originally for another sound source, or to data which has yet to be given a sound program assignment.
- ★ *Since a Patch which has been selected for a Part can be changed*, even a single Performance can be made to play any number of various Patches by switching among them. This is convenient when determining the Patch assignment for an entire Performance, or when switching only the Patch of the Part to be played from the keyboard while using a sequencer for backing parts.

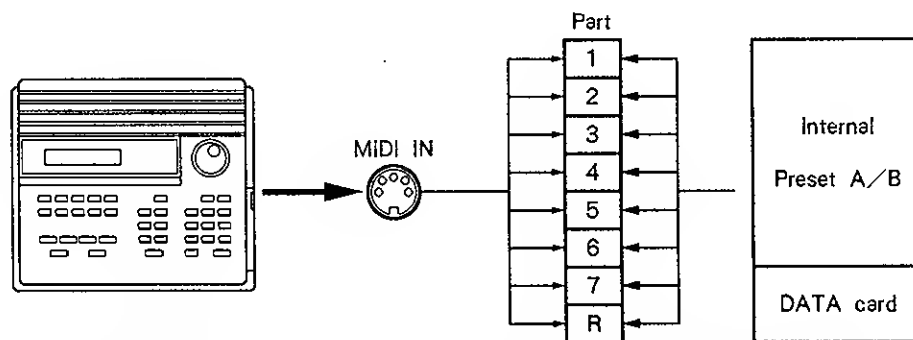

- Check play data you are unsure of by listening to each channel in turn.
 - Compare different instrumentations of the performance by trying different sound programs, switching the Patches assigned to each Part.
- ★ Be sure to reserve a sufficient number of voices for the important Parts in a song, or Parts that would stand out if the available voices were suddenly cut off. Voice shortage during realtime performance can be prevented by reserving a certain number of voices for the Part you intend to play live, while other performance data is being received from a sequencer.

● **Internal Zone Parameters**

These parameters control how the internal sound source responds to performance data received from the controllers of the JV-80.

- ★ By selecting different transpose settings for each Part, you can create an ensemble effect. For example, it is possible to play beyond the range of the keyboard, if you shift the key range of a bass sound down an octave and shift that for a piccolo up an octave. We suggest that you use the Coarse Tune setting, which is a Part parameter, to adjust the tuning of the sound program, and use the transpose function to adjust the tuning for the performance condition.

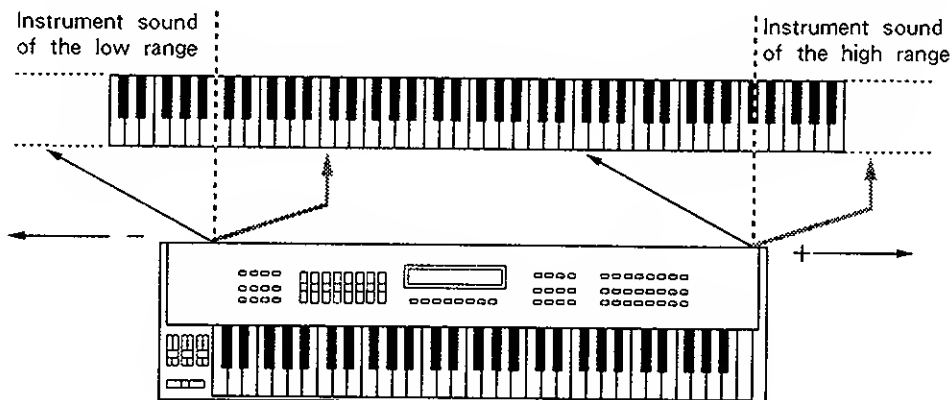

Shift the key range which can be played on the main keyboard.

- ★ The velocity received from the main keyboard is processed and sent to the Part in the *internal zone*. Since it is possible to control how each Part is processed, you can change the volume of each Part according to how strongly or lightly you play the keyboard.

For example, set the *velocity curve* to respond quickly for a Part that is to sound loudly. When you want a uniform velocity response, no matter how softly or strongly you play, set the *sensitivity* close to 0, and set the strength from the *Max Velocity* parameter. On the other hand, when you want to emphasize the velocity difference, set the sensitivity to values greater than 0.

It is also possible to limit the key range of each Part to different areas of the keyboard. This is used to temporarily change settings, such as for playing different Parts with each hand. For example, you could play a bass sound with your left hand and a piano with your right; or you could use the function to cut off higher or lower range sounds that are displeasing or unnatural.

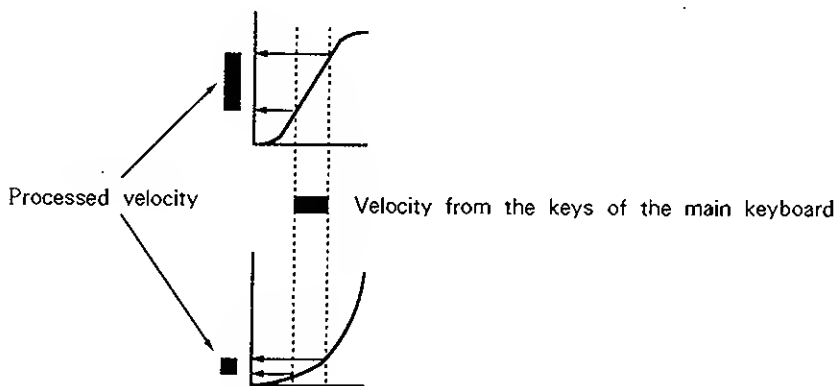

The same key velocity can be processed in different ways for different Parts.

- ※ The function of the internal zone is to process performance data and send it to the Part. The actual response of the sound to control in the Performance play mode depends on the Patch settings.

● Transmit Zone Parameters

These parameters are related to the MIDI transmission of the performance data, and they change the way sounds of the external sound source respond to the data. They consist of the same parameters used with Parts and internal zones described above, such as volume and velocity. The processed data is transmitted from the MIDI OUT terminal. The MIDI transmission channel of the transmit zone is like that of a Part, and the external sound source which is matched to the receiving channel is like a Patch. **It can be used not only for controlling several external sound sources as a master keyboard, but also can be used to edit the data of the device like a sequencer.**

★ *The method of operation for the transmit zone related to realtime play is the same as that of a Part or internal zone.* The explanation here describes how to create play data by various devices, including a sequencer. When entering play data, call up beforehand the Performance which was set at the beginning of the song. The program change number for selecting the Performance is :??: transmitted to the control channel; at the same time, the program change number and the volume information for the sound program which is to be used in the song is transmitted over the *MIDI transmission channel* of each transmit zone.

In this case, on the Parts for which transmission of data is not needed, set the MIDI transmit switch to OFF.

It is possible to transmit the necessary program change numbers, volume and pan data for the song in realtime. First, record only the play data for the song. Then, by controlling the transmit zone parameters while listening to the song, you can overdub volume and pan data or even record on another track.

This makes it easy to balance the relative volume of each sound program, letting you continuously fade in and fade out the tracks.

Performance is played by the data of **A** + **B**.

Also, if you record this onto another track of the sequencer, the two tracks, **A** and **B**, can be merged to one track.

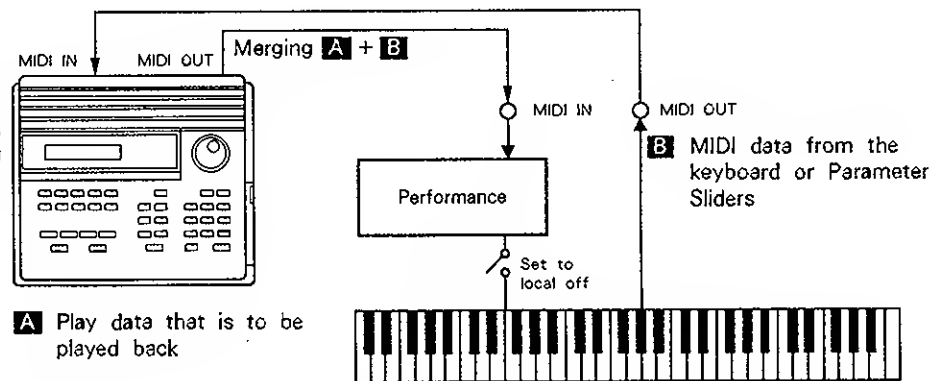

The velocity parameters are normally used to limit or emphasize velocity values in the play data. However, if you set each transmit zone to transmit with different velocity settings, you can in one pass simultaneously create a maximum of eight separate "blocks" of play data, each with different velocities. Moreover, by using the transpose or key range settings, it is possible to automatically transpose the data as you record it, or to split your keyboard performance data onto different channels depending on the key range; for example, separating the data of the right and left hand Parts. *Using the transmit zone settings in this way allows you process or edit the data in realtime as you play.*

※ There are parameters other than the parameters described above which do not belong to the Performance but are play-related and are common to the entire operation of the JV-80 (*system common parameters*). These settings are maintained and do not change even when selecting different Performances or entering other modes. (See P.72)

■ Operation

This section how to select Performances, how to select the LCDs (pages) in which the parameters are shown, and how to adjust and set the displayed parameters.

● Selecting the Performance Play Mode

Press the **PERFORMANCE PLAY** button to enter this mode.

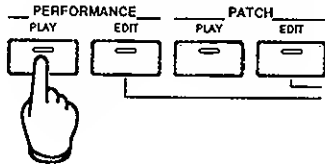

● Changing Performances

Press the **USER/PRESET** button to switch between User memory and Preset (A/B). (The indicator of the button lights when Preset is selected.)

When User memory is selected, pressing the **INT/CARD A/B** button switches between Internal and DATA card. When Preset is selected, pressing the **INT/CARD A/B** button switches between A and B. (The indicator of the button lights when the DATA card or Preset B is selected.)

※ If the DATA card has not been properly inserted into the DATA CARD slot, the DATA card Performance cannot be selected, even when **INT/CARD A/B** is pressed.

Press one of the **BANK** or **NUMBER** buttons to change the number. (The numbers 1 — 16 printed in blue indicate Performance numbers.)

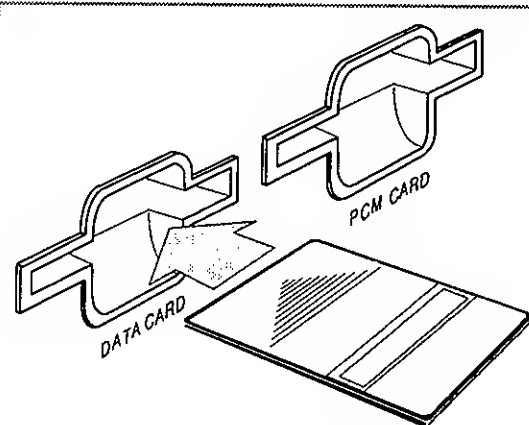
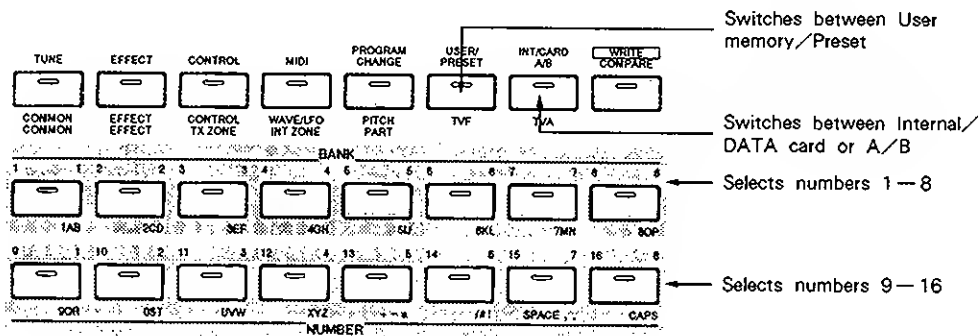

● Inserting DATA Cards

With the label side up, gently (but firmly) insert the DATA card into the DATA CARD slot on the rear panel. The DATA card has a special protect switch used to prevent accidental erasure of data stored in the card. Always make sure the Protect switch is On when inserting or removing the DATA card.

※ Use the optional M-256E for the DATA card.

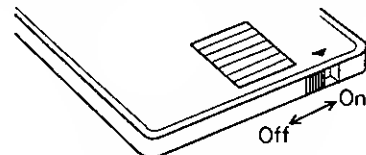

● Selecting and Adjusting the Performance Parameters with the Assign Buttons

Pressing one of the *assign buttons* calls up the Performance parameter corresponding to that button. (The letters printed in blue above the assign buttons indicate the Performance parameters.)

Once a parameter has been selected, a “#” or “#” mark is shown in the display, indicating that other display pages (showing additional parameters) can be selected. In this case, the display can be changed by pressing the ▲ and ▼ buttons.

One display of the several available displays is called a “page.” To switch (to move to another display) by pressing the ▲ and ▼ buttons is referred to as “selecting pages.”

[Example]

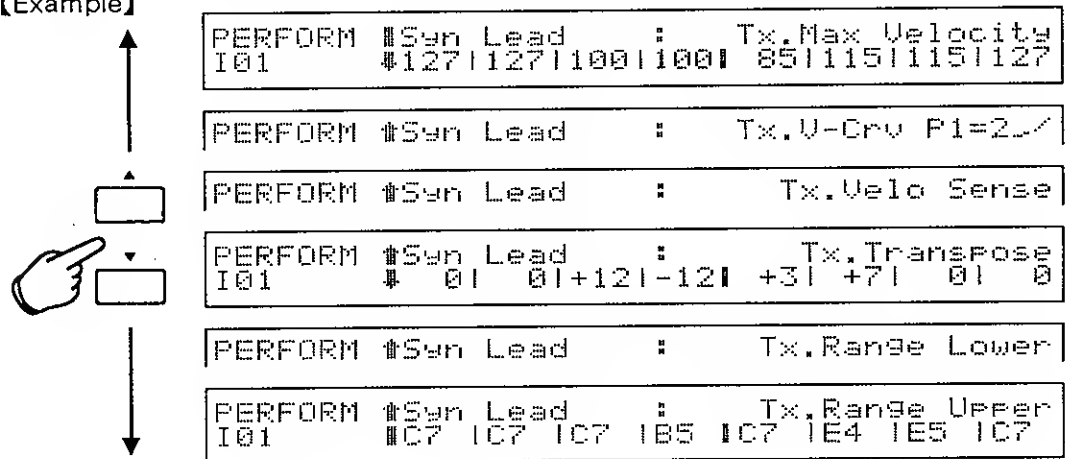

The value for the selected parameter of each individual Part is adjusted by using the appropriate *Parameter Slider*. Each number of the eight numbers in the display indicates the parameter value of each Part (in order from left to right). The number printed above each slider indicates the Part which can be operated by the slider.

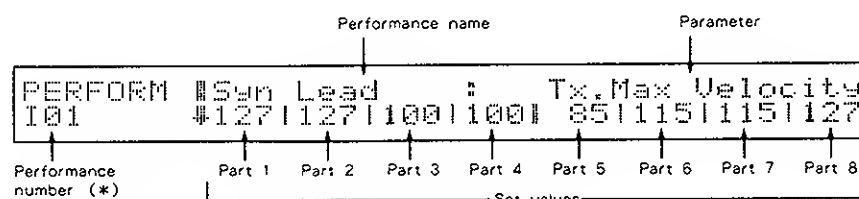
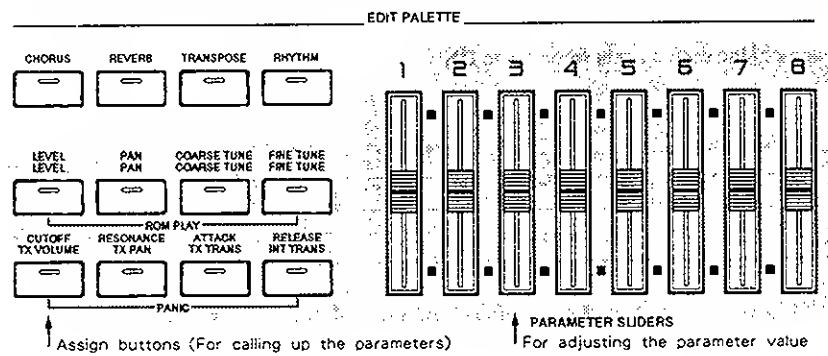

(*): I = Internal ; C = DATA card ; A or B = Preset

■ Operation

● Adjusting the settings with the **DEC** / **INC** buttons

You can also adjust the parameter values by using the **DEC** / **INC** buttons. Move the cursor to the Part to be changed using the **◀** / **▶** buttons, and press the **INC** button to increase the value or press the **DEC** button to decrease the value.

- ※ Holding down either the **DEC** / **INC**, **◀** / **▶** or **▲** / **▼** button steps continuously through the values (*auto repeat function*). You can move through the values even faster by holding down one of the two buttons and pressing the other one.

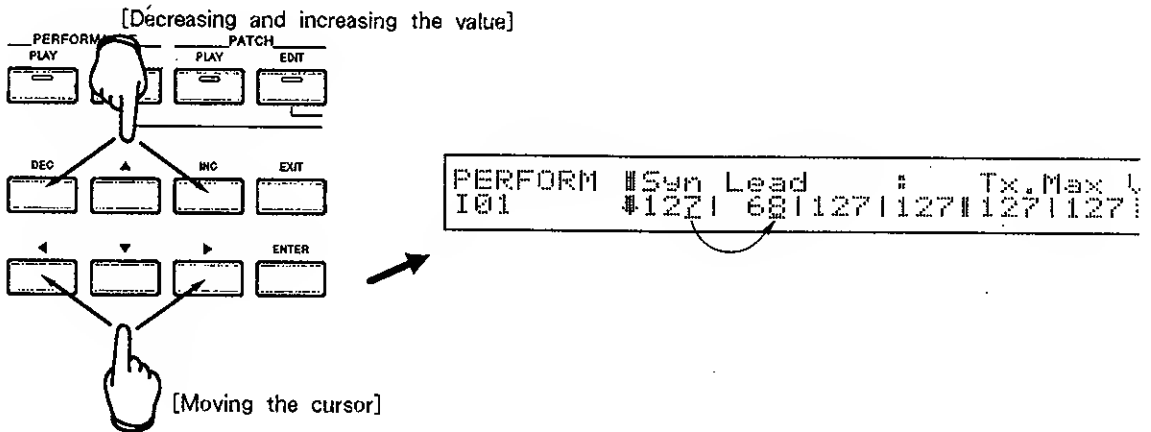

● How to use the **PART SWITCH**

When used during play of a Performance, the **PART SWITCH** buttons (1 — 8) function as on/off switches for receiving and transmitting MIDI data of each Part, and on/off switches for the sounding of each Part. *However, the on/off functions of the **PART SWITCH** buttons depends on the assign button which is currently active.*

- ※ The indicator of the button lights when set to ON.

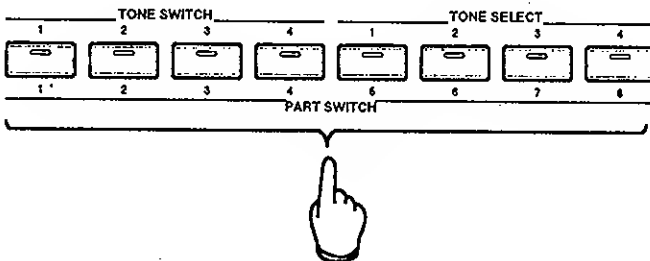



The on/off functions of the **PART SWITCH** (1 — 8) buttons are explained together with the operation of parameters, described in the next section.

LEVEL / **PAN** / **COARSE TUNE** / **FINE TUNE**

■ Explanations of the Parameters

Explanations of the Performance parameters are divided into the following categories:

- Part parameters
- Transmit zone parameters
- Internal zone parameters

These are followed by the parameters of the pages selected by  / , in the order that they are selected.

● Part Parameters

The relative level, pan and pitch values, which are set for the Patch, are adjusted.

When pressing the four buttons described below, the **PART SWITCH** buttons (1—8) function as MIDI receive switches for turning MIDI data reception of each Part on and off.

LEVEL *Part Level* Range: 0—127

This determines the volume level of the Part.

```
PERFORM ↑Syn Lead      :      Part Level
I01      ↓127|100|100| 85|100| 80|100|127
```

PAN *Part Pan* Range: <L64—0—63R>

This determines the fixed position of the Part's sound in the stereo image. Relative to the Patch setting, L64 is the farthest left, 0 is the Patch setting, 63R is the farthest right position.

```
PERFORM ↑Syn Lead      :      Part Pan
I01      ↓L64|L32|L10| 0 | 0 |10R|32R| 0
```

COARSE TUNE *Part Coarse Tune* Range: -48—+48

This determines the tuning of the Part. The tune of the Patch can be shifted in semitone increments. When set to a positive value (+), the greater the value, the higher the pitch. When negative (-), the greater the value, the lower the pitch.

```
PERFORM ↑Syn Lead      :      Part Coarse Tune
I01      ↓ 0| 0|+12|-12| +4| +7| 0| 0
```

FINE TUNE *Part Fine Tune* Range: -50—+50

This determines the fine pitch setting of the Part. It shifts the pitch set in the Patch in units of 1/100 of a semitone. When set to a positive value (+), the greater the value, the higher the pitch. When negative (-), the greater the value, the lower the pitch.

```
PERFORM ↑Syn Lead      :      Part Fine Tune
I01      ↓ -5|-10|+10| +5| 0| 0| 0| 0
```

LEVEL / **PAN** / **COARSE TUNE** / **FINE TUNE**

The display selected by **▲** (1 page)

Patch Select *Patch Select*

Settings: A-11 — 88/B-11 — 88/I-11 — 88/Rhythm Set (PRA/PRB/INT/CARD)

This determines the Patch to be assigned to each Part (Part 8 is used for the Rhythm Set). Selection can be made from a total of 256 programs: 64 from internal (I), 64 from DATA card (C), and 64 each from presets A and B. The Rhythm Set can be selected from preset A (PRA), preset B (PRB), internal (INT), and DATA card (CRD). When the Patch has been selected, the Patch name is shown at the top right of the display.

```
PERFORM | Patch Select P1=A.Piano 1
I01     | I11 I12 I13 I14 I15 I16 I17 INT
```

- ※ The lit indicators of **USER/PRESET** / **INT/CARD A/B** / **BANK** / **NUMBER** change depending on the selected Patch number. The Patches can also be changed by pressing these buttons. (The Performances cannot be changed.)
- ※ If the DATA card has not been properly inserted into the DATA card slot, the DATA card Patch cannot be selected.

The displays selected by **▼** (7 pages)

Receive Channel *Receive Channel* Range: 1 — 16

This determines the MIDI receive channel of each Part.

```
PERFORM | Syn Lead : Receive Channel
I01     | 1 2 3 4 5 6 7 10
```

Voice Reserve *Part Voice Reserve* Range: 0 — 28

This determines the number of voices that will sound for the Part. Keep in mind that a Part consists of a Patch, which in turn is made up of Tones. For example, in order to reserve two voices of a Patch made up of three Tones, set the value to six (3 Tones × 2 voices). Since the total number of voices on the JV-80 is 28, the total of the voice reserve settings for the Parts cannot exceed 28.

```
PERFORM | Syn Lead : Voice Reserve
I01     | 4 4 4 4 4 4 0 4
```

Chorus Switch *Chorus Switch* Settings: ON/OFF

This determines the ON/OFF setting for the chorus effect of each Part.

```
PERFORM | Syn Lead : Chorus Switch
I01     | ON OFF OFF ON ON OFF OFF
```

Reverb Switch *Reverb Switch* Settings: ON/OFF

This determines the ON/OFF setting for the reverb effect of each Part.

```
PERFORM #Syn Lead      :      Reverb Switch
I01      # ON1 ON1OFF1OFF1OFF1OFF1OFF1 ON
```

Receive P.C *Program Change Receive Switch* Settings: ON/OFF

This switch enables or disables reception of program change messages for each Part.

```
PERFORM #Syn Lead      :      Receive P.C
I01      #OFF1OFF1 ON1 ON1 ON1 ON1 ON1OFF
```

Receive Volume *Volume Receive Switch* Settings: ON/OFF

This switch enables or disables reception of volume data for each Part.

```
PERFORM #Syn Lead      :      Receive Volume
I01      #OFF1OFF1 ON1 ON1 ON1 ON1 ON1OFF
```

Receive Hold-1 *Hold 1 Receive Switch* Settings: ON/OFF

This switch enables or disables operation of the Hold 1 pedal for each Part.

```
PERFORM #Syn Lead      :      Receive Hold-1
I01      #OFF1OFF1 ON1 ON1 ON1 ON1 ON1OFF
```

- The Patches/Performances which are selected by receiving Program Change messages are as follows.

Patch Number	Program Change Number
I11—88	1—64
C11—88	65—128
A11—88	1—64
B11—88	65—128

Performance Number	Program Change Number
I01—16	1—16
C01—16	65—80
A01—16	1—16
B01—16	65—80

When the Bank Select in the Control Change messages then a Program Change number are received, Memory (User/Presets) and Patch/Performance will change. (For detailed explanation, refer to the MIDI Implementation Chart.)

TX VOLUME / **TX PAN**

● **Transmit Zone Parameters**

When pressing the two buttons described below, the **PART SWITCH** buttons (1—8) function as the MIDI transmit switches for turning MIDI data transmission of each Part on and off.

TX VOLUME *Transmit Volume* Range: 0 — 127

This determines the volume data transmitted over MIDI for the transmit zone of each Part.

```
PERFORM #Syn Lead : Transmit Volume
I01 #127|100|100| 85| 30| 80|100|127
```

- ※ When selecting a Performance whose transmit volume parameter (P.128) is set to OFF, "OFF" is displayed in the screen selected by pressing the **TX VOLUME** button. However, if the settings are later changed by the Parameter Slider or the **DEC** / **INC** buttons, "OFF" cannot be selected.

TX PAN *Transmit Pan* Range: L64 — 0 — 63R

This determines the pan data transmitted over MIDI for the transmit zone of each Part. The sound position is at the farthest left at L64, at the center at 0, and at the farthest right at 63R.

```
PERFORM #Syn Lead : Transmit Pan
I01 # 0 | 0 |L64|L32| 0 |32R|64R| 0
```

- ※ When selecting a Performance whose transmit pan parameter (P.129) is set to OFF, "OFF" is displayed in the screen selected by pressing the **TX PAN** button. However, if the settings are later changed by the Parameter Slider or the **DEC** / **INC** buttons, "OFF" cannot be selected.

The display selected by **▲** (1 page)

Transmit Program Change *Transmit Program Change* Settings: A11 — 88; B11 — 88

This determines the program change data transmitted over MIDI for the transmit zone of each Part. The letter indicates the group and the numbers 11 — 88 indicate the bank/number. The program change number (1 — 128) of the selected Part is indicated at the top right of the display.

```
PERFORM # Transmit Program Change P1=001
I01 #A11|A12|A13|A14|A15|A16|A17|A18
```

- ※ One of the indicators of the **INT/CARD A/B**, **BANK** and **NUMBER** buttons lights depending on the program change setting of the selected Part. It is possible to switch the program change to be transmitted by pressing these buttons.
- ※ When selecting a Performance whose program change parameter (P.128) is set to OFF, "OFF" is displayed in the screen selected by pressing the **▲** button. However, if the settings are later changed by the Parameter Slider or the **DEC** / **INC** buttons, "OFF" cannot be selected.

The display selected by **▼** (1 page)

Transmit Channel *Transmit Channel* Range: 1 — 16

This determines the MIDI transmission channel for the transmit zone of each Part.

```
PERFORM ↑Syn Lead      : Transmit Channel
I01      # 1| 2| 3| 4| 5| 6| 7| 10
```

TX TRANS *Transmit Transpose* Range: - 36 — +36

Note data from the keyboard is transposed for the transmit zone of each Part and is transmitted via MIDI.

```
PERFORM ↑Syn Lead      : Tx. Transpose
I01      # 0| 0|+12|-12| +3| +7| 0| 0
```

【Example】

When Tx. Transpose is set to +2

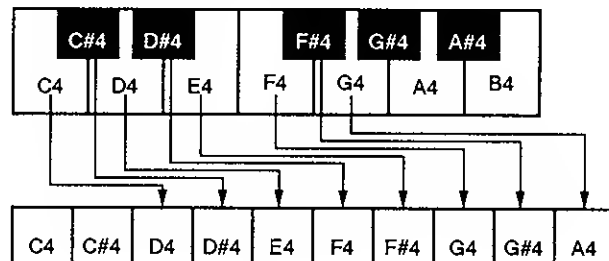

※ The setting here become invalid when the key mode is set to SINGLE (P.121).

When pressing this button described below, the **PART SWITCH** buttons (1 — 8) function as MIDI transmit switches for turning MIDI data reception of each Part on and off.

The display selected by **▲** (3 pages)

Tx.Velo Sense *Transmit Velocity Sensitivity* Range: - 63 — +63

This determines the amount of offset applied to the key velocity data before being transmitted as MIDI velocity data for the transmit zone of each Part.

```
PERFORM ↑Syn Lead      : Tx.Velo Sense
I01      #+32|+32|+10| 0|-10|-32|+25|+32
```

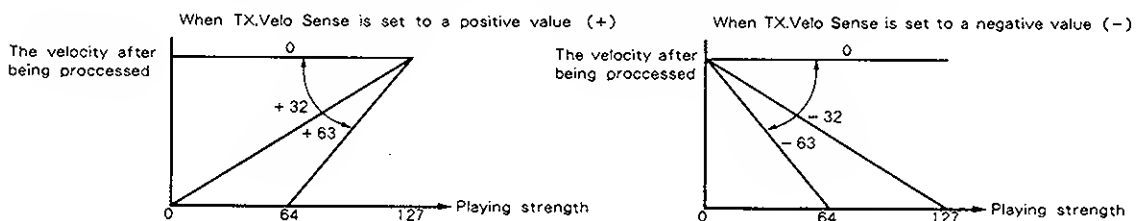

TX TRANS

Tx.V-Crv *Transmit Velocity Curve* Range: 1—7

The strength of the velocity sensed at the main keyboard is changed according to the curve set here, and the altered data is transmitted over MIDI for the transmit zone of each Part. The mark which indicates the shape of the selected curve is shown at the top right of the display.

```
PERFORM #Syn Lead : Tx.V-Crv P1=2 ✓
I01 # 21 31 11 41 21 11 61 2
```

Velocity curves

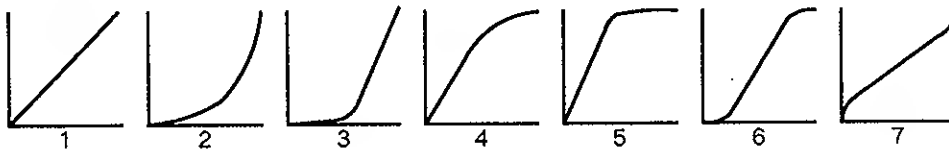

Tx.Max Velocity *Transmit Max Velocity* Range: 0—127

This determines the maximum value of the velocity data which is transmitted over MIDI for the transmit zone of each Part. This function compresses the original velocity data sensed at the main keyboard and transmits the altered (reduced) velocity data.

```
PERFORM #Syn Lead : Tx.Max Velocity
I01 #127|127|100|100| 80|115|115|127
```

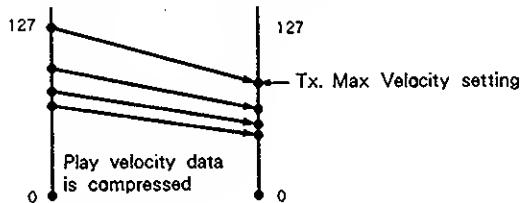

【Example】

Max velocity 100
 Velocity curve 6
 Velocity sensitivity +32
 Using the combined values above results in the velocity response shown at the right.

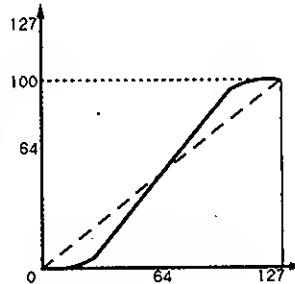

The display selected by ▼ (2 pages)

Tx.Range Lower Transmit Zone Key Range Lower Range: C-1 — G9
Tx.Range Upper Transmit Zone Key Range Upper Range: C-1 — G9

These two pages determine the low and high key limits for the transmit zone of each Part. From the note data received from the main keyboard, only note data falling within the specified key range is transmitted for each transmit zone.

```
PERFORM #Syn Lead : Tx.Range Lower
I01 #C2 IC2 IC2 IC3 IC5 IE3 IF4 IC2
```

```
PERFORM #Syn Lead : Tx.Range Upper
I01 #C7 IC7 IC7 IB5 IC7 IE4 IE5 IC7
```

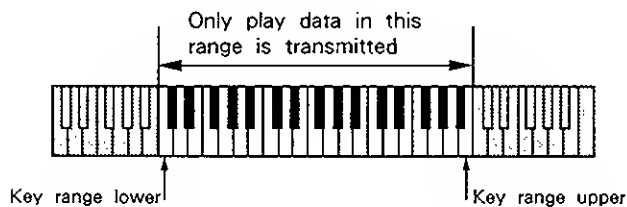

※ When the Key mode (P.121) is set somewhere outside of the zone, the setting of the key range here is not effective.

INT TRANS

● **Internal Zone Parameters**

As with the transmit zone, the play data is processed for the internal zone, and passed on to the Patch, even though the method of processing the play data is the same as that of the transmit zone.

When pressing the button described below, the **PART SWITCH** buttons (1—8) function as local on/off switches for turning reception of play data from the keyboard on and off for each Part.

INT TRANS *Internal Transpose* Range: - 36 — +36

The note data from the keyboard is transposed for the internal zone of each Part, and is passed on to the Patch which is assigned to the Part.

```
PERFORM #Syn Lead : Int.Transpose
I01 # 01 01+121-121 +41 +71 01 0
```

※ The setting here become invalid when the key mode is set to SINGLE (P.121).

The display selected by  (3 pages)

Int.Velo Sense *Internal Velocity Sensitivity* Range: - 63 — +63

This determines the amount of offset applied to the key velocity data before being transmitted as velocity data for the internal zone of each Part.

```
PERFORM #Syn Lead : Int.Velo Sense
I01 #+321+321+101 01-101-321+251+32
```

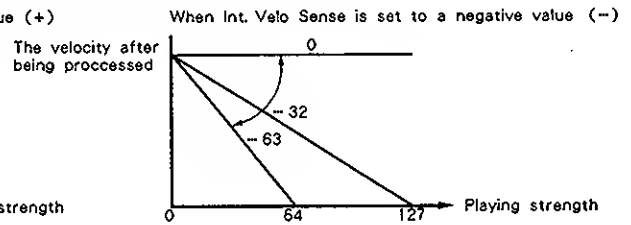
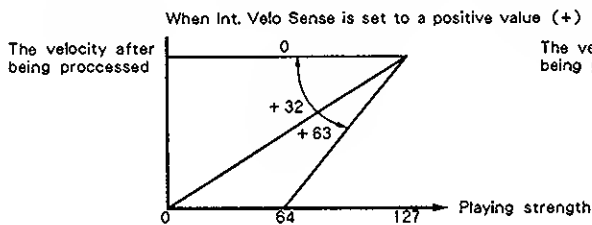

Int.V-Crv *Internal Velocity Curve* Range: 1 — 7

The strength of the velocity sensed at the main keyboard is changed according to the curve set here, and the altered data is transmitted for the internal zone of each Part. The mark which indicates the shape of the selected curve is shown at the top right of the display.

```
PERFORM #Syn Lead : Int.V-Crv P1=2
I01 # 21 31 11 41 21 11 61 2
```

Velocity curves

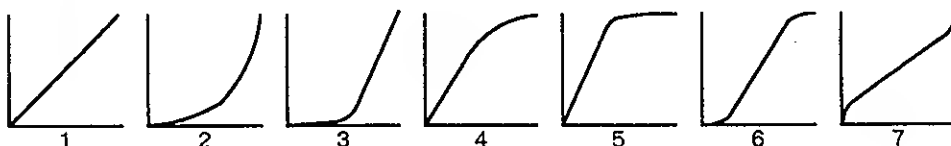

Int.Max Velocity *Internal Max Velocity* Range: 0—127

This determines the maximum value of the velocity data which is transmitted for the transmit zone of each Part. This function compresses the original velocity data sensed at the main keyboard and transmits the altered (reduced) velocity data to the Patch.

```
PERFORM #Syn Lead : Int.Max Velocity
I01 #127|127|100|100| 50|115|115|127
```

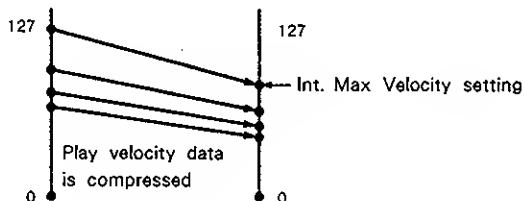

【Example】

Max velocity 110
 Velocity curve 4
 Velocity sensitivity -32
 Using the combined values above results in the velocity response shown at the right.

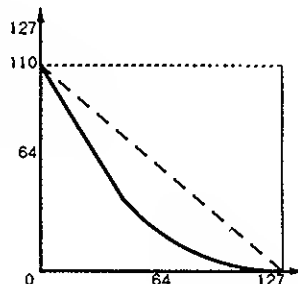

The display selected by (2 pages)

Int.Range Lower *Internal Zone Key Range Lower* Range: C2—C7

Int.Range Upper *Internal Zone Key Range Upper* Range: C2—C7

These two pages determine the low and high key limits for the internal zone of each Part. From the note data received from the main keyboard, only note data falling within the specified key range is passed on to the Patch.

```
PERFORM #Syn Lead : Int.Range Lower
I01 #C2 IC2 IC2 IC3 IC5 IE3 IF4 IC2
```

```
PERFORM #Syn Lead : Int.Range Upper
I01 #C7 IC7 IC7 IE5 IC7 IE4 IE5 IC7
```

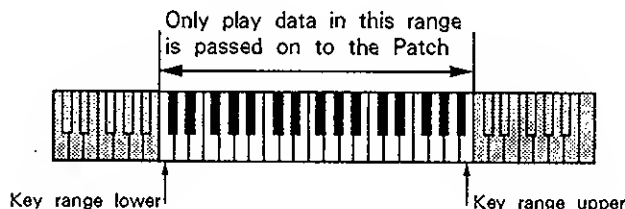

3. Other Play Operations

Setting of the effects (chorus/reverb) and setting the transmission status of program change messages can be directly called up by the buttons and operated from the Patch or Performance parameters which are currently selected.

■ Operation

When **EFFECT** or **PROGRAM CHANGE** is pressed (the indicator lights), several parameters are indicated on the upper line of the LCD, and the set values of each parameter are indicated on the lower line. The parameters correspond, from left to right, to the Parameter Sliders 1 — 8. Use the appropriate Parameter Slider to edit the desired parameter.

【Example】 When pressing **EFFECT** :

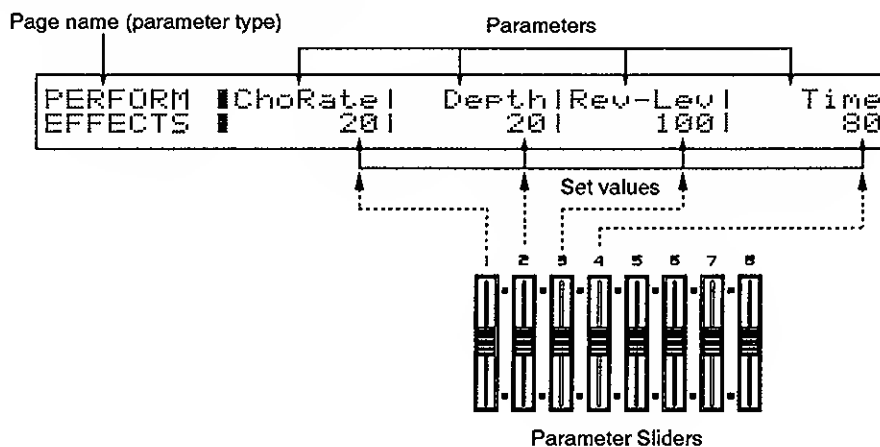

The set value can be changed by using **DEC** and **INC**.

Move the *CURSOR* below the set value of the parameter to be changed by pressing **◀** or **▶**, and press **INC** to increase the value and **DEC** to decrease the value.

- ※ Holding **DEC** / **INC** or **◀** / **▶** down starts the *auto repeat function*, letting you continuously change the value. You can speed up the change in values by holding down one button and then pressing and holding down the other button.

■ Explanations of the Parameters

EFFECT

EFFECTS Page

This determines the effect parameters of Patches in the Patch Play mode, and the effect parameters of Performances in the Performance Play mode.

● During Patch Play Mode Operation

PATCH	ChoRate	Depth	Rev-Lev	Time
EFFECTS	20	20	100	80

● During Performance Play Mode Operation

PERFORM	ChoRate	Depth	Rev-Lev	Time
EFFECTS	20	20	100	80

ChoRate *Chorus Rate* Range: 0 — 127

This determines the modulation speed of the chorus sound. The greater the value, the faster the modulation speed.

Depth *Chorus Depth* Range: 0 — 127

This determines the depth of the chorus effect. The greater the value, the more pronounced the chorus effect.

Rev-Lev *Reverb Level* Range: 0 — 127

This determines the level of the reverb sound. The greater the value, the higher the reverb level.

Time *Reverb Time* Range: 0 — 127

This determines the time of the reverberant decay sound. The greater the value, the longer the reverberant decay.

PROGRAM CHANGE

PROGRAM CHANGE

TRANSMIT P.C Page

TRANSMIT	Tx-Ch	P.C-No		
P.C	1	012/A24	-----	-----

Tx - Ch *Transmit Channel* Range: 1 — 18

This determines the channel over which program change messages are transmitted.

P.C - No *Program Change Number* Range: 001/A11 — 128/B88

This determines the program change number that is transmitted over the channel set in the Tx-Ch parameter above.

The number to the left of the slash mark (/) is the program change number. The value to the right of the slash mark is the number when it is set to the group/bank/number method. Depending on the program change number selected, the indicator lights of the **USER/PRESET** / **INT/CARD A/B** / **BANK** / **NUMBER** buttons change.

- ※ When the cursor is at the program change number, a number between 001 and 128 can be directly specified. Since **BANK** 1 — 8 and **NUMBER** 1 — 2 correspond to numbers 1 — 0 (the numbers are printed directly beneath the buttons), press the **BANK** / **NUMBER** button which corresponds to the desired program change number, then press **ENTER**.

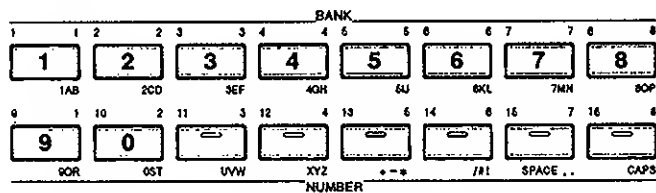



When using the group/bank/number method, the program change number can be specified by pressing the buttons in this order: **USER/PRESET** / **INT/CARD A/B** / **BANK** / **NUMBER**.

● Panic function

This returns all devices, including those connected by MIDI, to the normal condition. It is used to stop "stuck" notes from continually sounding.

【Operation】

Press the  button while holding down the  button.

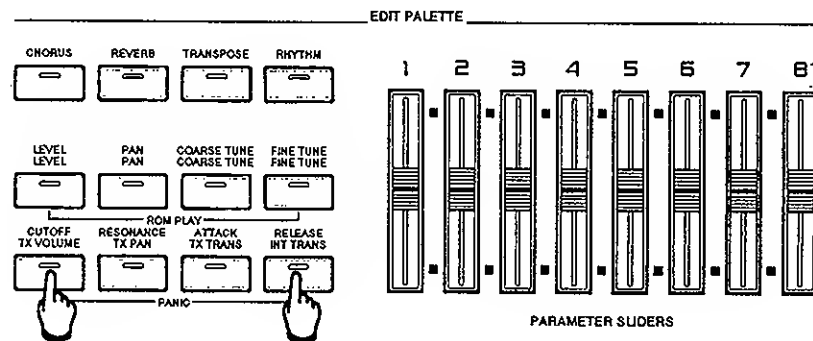

When the buttons are pressed down for a short time (less than one second), they transmit key off/hold off messages over the channels where the internal sound source mute and key on/hold on are applied. When the button is held down for more than one second, the following messages are transmitted over all channels:

All note off	(note off velocity 127)
Pitch bender	center
Channel aftertouch	0
Modulation	0
Hold 1	0
Volume	127

4. System Common Parameters

The parameters whose settings are common to the entire operation of the JV-80 are called *system common parameters*. The system common parameters that are related to the Patch Play mode or Performance Play mode are explained in this section. Remember that the parameters operated here are effective regardless of changes in the selection of Performances or Patches.

Operation

When one of the **TUNE**, **CONTROL** or **MIDI** buttons is pressed (the indicator lights), several parameters are indicated on the upper line of the LCD, and the set values of each parameter are indicated on the lower line. The parameters correspond, from left to right, to the Parameter Sliders 1 — 8. Use the appropriate Parameter Slider to edit the parameter you wish to change.

Select different display pages by pressing **▲** or **▼**, when “**⏏**” or “**⏏**” are indicated in the LCD.

【Example】 When pressing **TUNE**:

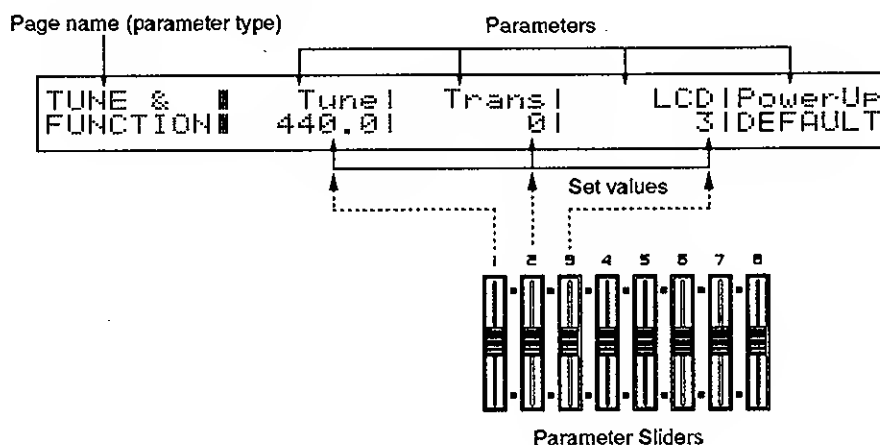

The set value can be changed by using **DEC** and **INC**.

Move the *CURSOR* below the set value of the parameter to be changed by pressing **◀** or **▶**, and press **INC** to increase the value and **DEC** to decrease the value.

- ※ Holding **DEC**/**INC**, **◀**/**▶** or **▲**/**▼** down starts the *auto repeat function*, letting you continuously change the value. You can speed up the change in values by holding down one button and then pressing and holding down the other button.

■ Explanations of the Parameters

TUNE TUNE & FUNCTION Page

```
TUNE &  | Tune | Trans | LCD | PowerUp
FUNCTION | 440.0 | 0 | 3 | DEFAULT
```

Tune *Master Tune* Range: 427.4 — 452.6Hz

This determines the overall tuning of the JV-80. The value indicates the frequency at A4.

Trans *Transpose* Range: -36 — +36

This is used to adjust the overall pitch of the JV-80 in semitone units. The transpose that was set here can be switched ON/OFF by **TRANPOSE** button.

LCD *LCD Contrast* Range: 0 — 10

This determines the contrast setting of the display.

PowerUP *Power Up mode* Settings: LASTSET/DEFAULT

This determines the automatic voice selection condition of the instrument when the power is turned on.

LASTSET : The last Patch or Performance selected before the power was previously turned off is automatically selected when the power is turned back on.

DEFAULT : Patch 111 or Performance 101 is automatically selected when the power is turned back on.

CONTROL (5 pages)

PEDAL 1 ASSIGN, PEDAL 2 ASSIGN, C1 ASSIGN Pages

```
PEDAL1 | Model | Assign | (Val:127)
ASSIGN | INT | CC07/VOLUME | |----|----
```

```
PEDAL2 | Model | Assign | (Val:127)
ASSIGN | MIDI | CC11/EXPRESSION | |----|----
```

```
C1 | Model | Assign | (Val:127)
ASSIGN | I+MIDI | CC11/BEND-UP | |----|----
```

These pages are used to assign parameter control for foot pedals 1 and 2 (connected to the pedal jacks 1/2) and the C1 slider.

CONTROL

Mode *Output mode* Settings: OFF/INT/MIDI/I + M

This determines the destination of the data which is controlled by the pedals or CI slider. The INT setting sends the data to the internal sound source only. The MIDI setting sends the data only to the MIDI OUT terminal. The I + M setting sends the data to both the internal sound source and the MIDI OUT terminal. It does not function when set to OFF.

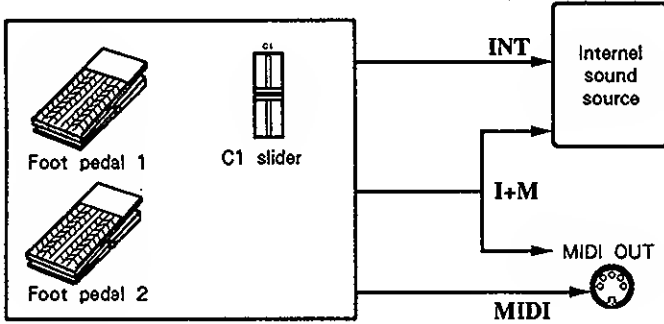

Assign *Assign*

Settings : CC0 — CC95/AFTERTOUCHE/BEND-UP/BEND-DOWN/PROG-UP/PROG-DOWN

This determines the parameters which are controlled by the pedals or CI slider. The CC0 — CC95 setting switches among MIDI control change numbers 0 — 95. The AFTERTOUCHE setting corresponds to aftertouch. The BEND-UP/BEND-DOWN settings correspond to pitch bend up and down. And the PROG-UP/PROG-DOWN setting selects the next Performance/Patch number. The value in parentheses () indicates the current value of the pedal/C1 slider.

PEDAL POLARITY Page

```

PEDAL  ↑ Pedal1 | Pedal2 | Hold |
POLARITY ↓ STANDARD | STANDARD | REVERSE | ----
    
```

PEDAL 1 | PEDAL 2 | HOLD Settings: STANDARD/REVERSE

This parameter lets you set the JV-80 so that it matches the polarity of the pedal switch connected to pedal jacks 1 and 2 and the hold pedal jack. Set it to STANDARD when using a Roland pedal switch (DP-2).

Set it to REVERSE when using other manufacturers' pedal switches that have reverse polarity. (For example, a pedal with reverse polarity connected to the hold pedal jack would sustain the sound when the pedal is not pressed.)

AFTERTOUCHE Page

```

AFTER  ↑ Thresh |
TOUCH  ↓ 10 | ---- | ---- | ----
    
```

Thresh *Threshold* Range: 0 — 127

This determines the value (threshold) at which aftertouch begins to affect the sound. When the aftertouch value is smaller than the threshold setting, it does not function. When the threshold is set to 127, it does not function either.

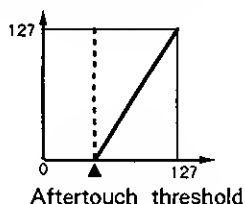
**MIDI** (5 pages)

The first page to be displayed when this button is pressed differs depending on the mode selected.

【When Patch Play mode is selected:】**PATCH MIDI** Page

PATCH	▮	Local	1	Rx-Ch	1	Tx-Ch	1	-----
MIDI	▮	ON		1		Rx-Ch		-----

Local *Local Switch* Settings: ON/OFF

When this is set to ON, the internal sound source of the JV-80 receives and responds to play data from the instrument. When set to OFF, the sound source ignores the data. This, however, has no effect on the transmission and reception of MIDI data.

Rx-Ch *Patch Receive Channel* Range: 1 — 16

This determines the MIDI receive channel in the Patch Play mode.

Tx-Ch *Transmit Channel* Range: 1 — 16/Rx-Ch/OFF

This determines the MIDI send channel in the Patch Play mode. The Rx-Ch setting indicates that the transmission channel is the same as that of the receive channel. It does not transmit when set to OFF.

【When Performance Play mode is selected:】**PERFORM MIDI** Page

PERFORM	▮	Local	Ctrl-Ch	1				-----
MIDI	▮	ON		OFF				-----

Local *Local Switch* Settings: ON/OFF

When this is set to ON, the internal sound source of the JV-80 receives and responds to play data from the instrument. When set to OFF, the sound source ignores the data. This, however, has no effect on the transmission and reception of MIDI data.

MIDI

Ctrl-Ch *Control Channel* Range: 1 — 16/OFF

Distinguishing between the send and receive channels of each Part of the Performance, this determines the channel for switching the Performances. When this channel is set to the same receive channel of a Part, switching of Performances has priority. Neither transmission or reception is possible when this is set to OFF.

※ *MIDI send and receive channels of each Part are set with the Performance parameters.*

TRANSMIT MIDI/RECEIVE MIDI Page

```

TRANSMIT P.C|Bnk|C.C|Vol|Bend|Mod|Aft|
MIDI     ↓ ON| ON| ON| ON| ON| ON| ON|--
RECEIVE  P.C|Bnk|C.C|Vol|Bend|Mod|Aft|
MIDI     ↓ ON| ON| ON| ON| ON| ON| ON|--
    
```

P.C **Bnk** **C.C** **Vol** **Bend** **Mod** **Aft** Settings: ON/OFF

When set to ON, these allow reception and transmission of the corresponding MIDI data. Setting to OFF disables reception and transmission of the data.

- P.C* *Program change*
- Bnk* *Bank select*
- C.C* *Control change (*)*
- Vol* *Volume (*)*
- Bend* *Pitch bend (*)*
- Mod* *Modulation (*)*
- Aft* *Aftertouch (*)*

Data types which are marked with an asterisk (*) cannot be controlled by either the JV-80 or a pedal when RECEIVE MIDI pages are set to OFF.

SYS-EX MIDI Page

```

SYS-EX  ↑Receive|Unit-No|
MIDI    |         ON|   17|-----|-----
    
```

Receive *Exclusive Receive Switch* Settings: ON/OFF

This turns on and off the JV-80's original MIDI data, such as Performance data and Patch data.

Unit-No *Unit Number* Range: 17 — 32

When receiving system exclusive messages, set this to the same unit number of the transmitting device.

SECTION 4

EDIT

SECTION 4

1. Patch Edit

What is the Patch Edit mode?

The Tone is the basic building block for sound programs, and the JV-80 is capable of making various kinds of sounds. A Patch, on the other hand, is the basic unit of sound which is stored in memory and called up for playing. A Patch can be made by using a maximum of four Tones together. When creating a Patch, it is helpful to look at it as more than just sounding several Tones simultaneously, but rather as making a single sound by judiciously layering the Tones.

The Tone parameters of the JV-80 correspond to the various characteristics of the sound elements (timbral quality of the sound, its frequency, its volume, and the ways of changing them). The sound of the internal sound source differs depending on the settings of these parameters. The main work in crafting sounds with a synthesizer is in setting and adjusting these parameters. However, there are also other parameters that are used to determine Patch names and effect settings in the Patch Play mode. These parameters, along with the Tone parameters, make up what are called Patch parameters. The operations for setting the Patch parameters are referred to as Patch Edit operations. This means that Tone edit operations are included in the Patch Edit mode. There are four groups of Tone parameters for a Patch parameter; only the parameters necessary for the Patch need be set. The unnecessary groups of Tone parameters do not sound when the Tone switch parameter is set to OFF.

The Tone parameters make it possible to take a sound and apply various functions in order to subtly alter, or "synthesize" it into a completely new sound. The structure of the Tone is shown below.

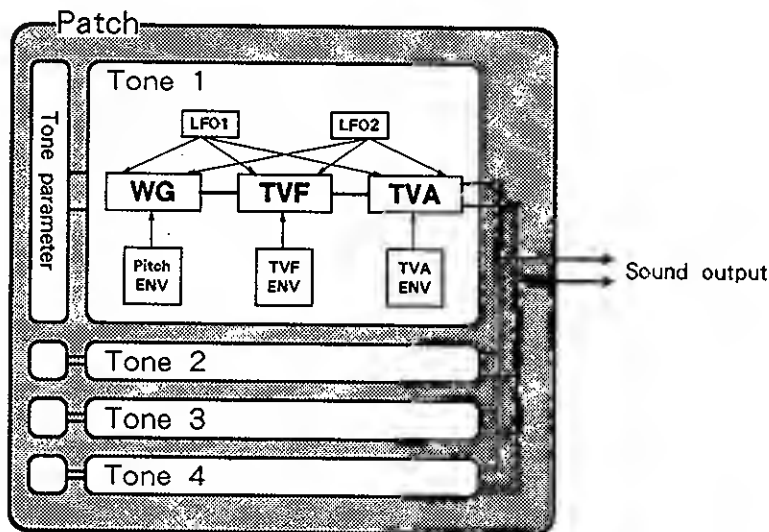

● **WG (Wave Generator)**.....

This calls up the waveform (source wave) data stored in internal memory, on an optional PCM card or expansion board, and generates an original wave form. At the same time, it also controls the pitch of the waveform. Generally, the waveform determines the basic characteristics and quality of the sound.

● **TVF (Time Variant Filter)**.....

This shapes the sound by processing the original waveform generated by the wave generator. It determines the timbral qualities of the sound by cutting or boosting the frequency elements in the original waveform.

● **TVA (Time Variant Amplifier)**.....

This controls the volume of the sound that is output.

● **ENV (Envelope Generator)**.....

Independent envelope generators are available for the WG, TVF and TVA, and they apply changes over time to the pitch, frequency elements and level of the sound. The envelope has three different time settings and three level settings from the pressing of a key (key on); the third level is the sustain level. There is one setting for each time and level after the key is released (key off). (However, the key off level is fixed at 0 for the TVA parameters.)

● **LFO**.....

LFO can be applied to the WG, TVF and TVA, for adding periodic change to the pitch, frequency elements and level of the sounds. It adds expression to the sound by providing waveform motion and vibration. The speed of the LFO is global that is, the same speed is used for the WG, TVF and TVA however, the depth can be set independently. There are two LFOs, LFO 1 and 2, and they can be used simultaneously to modulate the same parameter.

How to Edit in the Patch Edit Operations

- Press **PATCH EDIT** after selecting the Patch to be edited. Then press one of the function select buttons to call up the desired Patch parameter.
(The letters printed in orange underneath the buttons indicate the Patch parameters.)

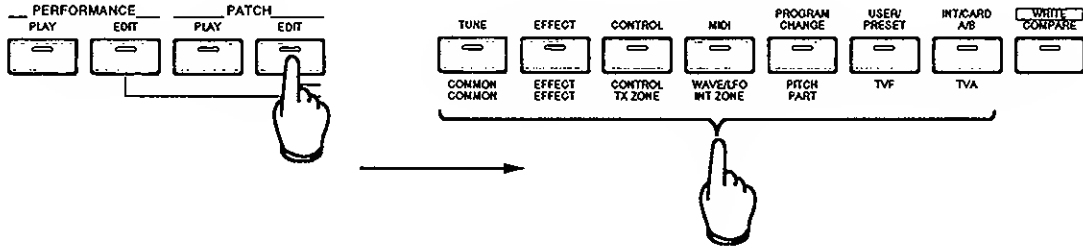

- The screen shown below will appear when the Patch Edit mode is selected.

【Example】

Page name	(parameter type)	Related parameters					
PATCH	Type	Lev	Rat	Def	Fbk	Out	
CHORUS	#CHO1	100	60	20	0	MIX	-- ---
		Set values					

The set values correspond, from left to right, to Parameter Sliders 1 — 8. Use the appropriate Parameter Slider to edit the parameter you wish to change.

【Example】

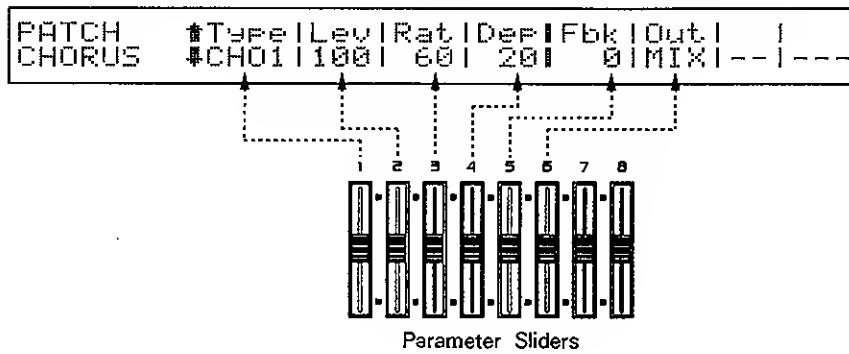

Select different display pages by pressing **▲** or **▼**, when “**#**” or “**■**” are indicated in the LCD.

The set values can be adjusted using the **DEC** / **INC** buttons.

Match the cursor to the value to be changed by pressing **◀** / **▶**, and press **INC** when increasing the value, and press **DEC** when decreasing the value.

- ※ Holding **DEC** / **INC**, **◀** / **▶** or **▲** / **▼** down starts *the auto repeat function*, letting you continuously change the value. You can speed up the change in values by holding down one button and then pressing and holding down the other button.

● Using **TONE SELECT**

When setting the parameters for each Tone (1 — 4), the indication “**1** — — —” is shown in the upper left of the LCD. This indicates the Tone number currently selected.

From this display, you can select individual Tones using the **TONE SELECT** buttons 1 — 4.

- ※ The indicators of the buttons light up when set to ON.

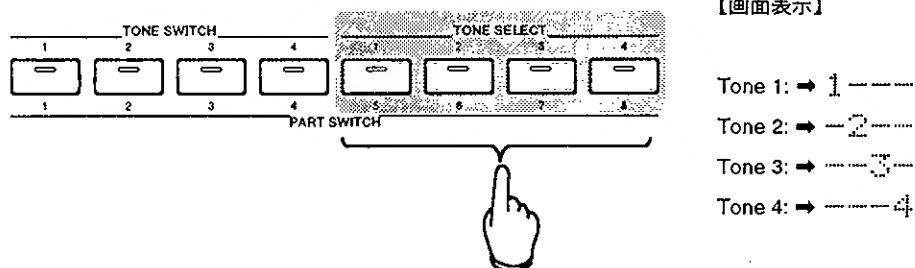

It is also possible to press down several **TONE SELECT** buttons simultaneously. The Tone number which was last selected is displayed in the LCD, and other selected Tone numbers are indicated by an asterisk (*). Doing this sets all parameters to the same value for all the selected Tones.

【Example】

When pressing **TONE SELECT** (1) while simultaneously holding down **TONE SELECT** (3):

↓
1 — * —



● Selecting Parameters with the Assign Buttons



The following screen appears in the LCD when pressing one of the Assign buttons in the Patch Edit mode.

PATCH	♯			TVA Level
EDIT	♯	127	127	127 127

Once this display appears in the LCD, it is possible to edit the selected parameter in the Patch Play mode by pressing one of the assign buttons. The LCD structure and operations are the same as those in the Patch Play mode. However, when the Patch Edit mode is selected, “**PATCH EDIT**” is indicated at the left of the display.

● Switching Between Display Pages

Several display pages can be assigned to a function select button. It is possible to switch between two pages each time you press the function select button (the button whose indicator is currently lit): one page is selected by pressing  and the other page is selected by pressing .

By using this function, you can continue editing while comparing parameters on the two pages, or you can immediately select often used pages by pressing  and , saving you time by eliminating the normal page selection steps.



The manner in which pages are switched when the function select button is pressed is shown below.

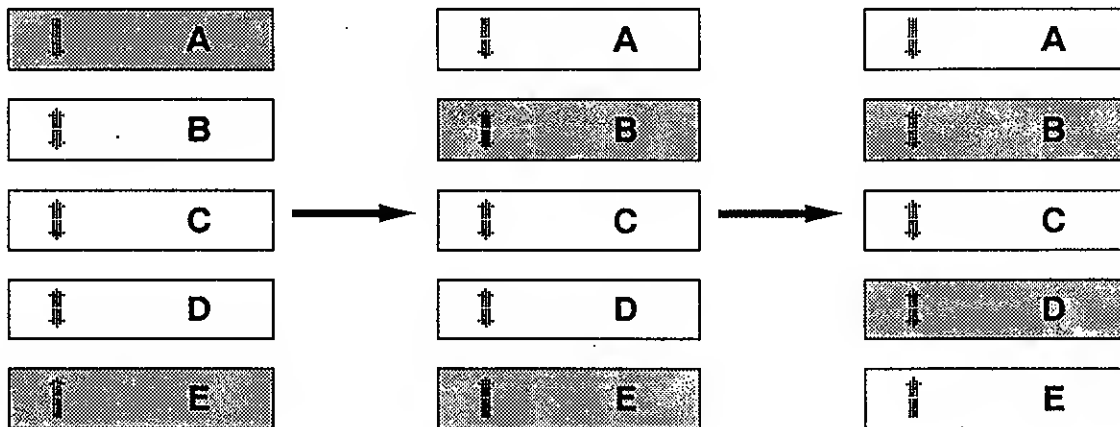

When the power is turned on, you can switch between the first page (A) and the last page (E) each time you press the function select button.

When (A) is selected and you change it to (B) by pressing , you can switch between (B) and (E) each time you press the function select button.

When (E) is selected and you change it to (D) by pressing , you can switch between (B) and (D) each time you press the function select button.



※ When the same page is selected by /, the selected page and the first page are switched each time you press the function select button.

When both  and  are used to select the first page, the first page and the last page are switched.

■ Explanations of the parameters

From this point on, the main parameters of each button and their uses are described, followed by explanations of functions.

Parameters Selected by **COMMON** (3 Pages)

On these pages, the parameters which are common for all the Patches are set.

- ★ The timbral quality of the sound of acoustic instruments changes depending on the strength with which they are played. You can recreate that natural expressive quality in the following way. Use several Tones and set different velocity ranges over which each Tone will sound; in this way, different Tones will sound depending on the strength with which the keys are played.

You can also use this with *the key range parameter of a Performance* to have different Patches sound depending on the range of the keyboard. This lets you recreate the authentic sound changes that occur over the range of acoustic instruments, such as with an acoustic piano, as well as reproduce the changes that occur with playing strength.

PATCH NAME Page

PATCH NAME [Woody Bass 1]

Patch Name Settings: Space, A—Z, a—z, 1—9, 0, + - * / # ! , .

The Tone being edited can be named with a maximum of 12 characters. Move the cursor by using Parameter Slider 2 or the ◀/▶ buttons. Select the characters at the cursor position using Parameter Slider 1 or the **INC**/**DEC** buttons.

Characters can also be selected by using the buttons shown below. (The characters and designations are printed in gray directly beneath the buttons.) Press the desired button repeatedly to step through the three-character selection.

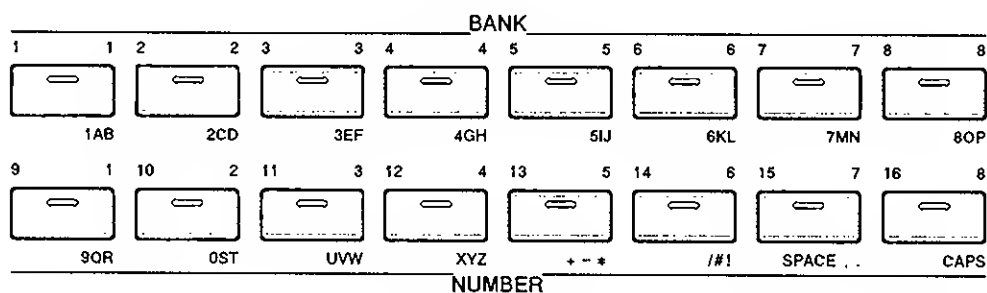

CAPS: Pressing this button switches between capital letters and small letters. When the indicator is lit, it is set to capital letters.

SPACE: This is for entering a space between characters.

COMMON

PATCH COMMON Page

PATCH	#	Level	Pan	Velo-Sw
COMMON	#	127	0	OFF

Level Patch Level Range: 0 — 127

This determines the level (sound volume) of the Patch.

This parameter sets the level of the entire Patch, even though separate values for the TVA level for each Tone of the Patch are set.

Pan Patch Pan Settings: L64 — 0 — 63R

This determines the stereo position of the Patch. The sound position is at the farthest left at L64, at the center at 0, and at the farthest right at 63R. Pan can also be set for each Tone in the Patch. Each Tone is positioned to either the left or right of the pan position set here according to its individual pan setting.

Velo-Sw Velocity Range Switch Settings: ON/OFF

The velocity setting is effective when this is set to ON, and ignored when set to OFF.

VELOCITY RANGE Page

VELOCITY	#	Tone 1	Tone 2	Tone 3	Tone 4
RANGE	#	0 127	0 127	0 63	64 127

Tone 1 **Tone 2** **Tone 3** **Tone 4** Range (for each): 0 — 127

This determines the velocity range (lower/upper) of each Tone. Only play data which falls within the specified velocity range will produce sound. The left side is the lower value and the right side is the upper.

Parameters Selected by **EFFECT** (4 Pages)

These are used to set the internal effects that are applied to Patches called up in the Patch Play mode. The effect is applied equally to all Patches. The effects can be used for a wide range of sound processing applications, from subtly enhancing the sound to completely changing it.

- ✂ The effects follow the settings made for the Performance in the Performance Play mode.
- ★ *Chorus* adds thickness and brightness to the sound. For example, adding chorus to orchestral strings creates a certain expansion and thickness in the sound. The brightness and depth are also increased when the chorus effect is put on electric piano and bell programs. Chorus also lets you create movement and vibration by modulating the sound. The speed of the modulation is set by *the rate*, and *the depth* of modulation is set by the depth. Using this with the *LFO* allows you to create a highly animated, complex modulation effect.
- ★ The balance of the chorus sound for each Tone is set by the *chorus send level*. Set the *send level* higher to add a soft sheen to a sound, or set the *send level* lower to emphasize the sharp attack and overall clarity of a sound.
- ★ You can make the chorus effect more pronounced and complex by routing the sound, which is output by the *chorus feedback* control, back to the chorus effector again. You can also process the chorus sound with reverb for a particularly rich sound by setting the *output switch* of chorus to REV.
- ★ The *reverb* effect simulates the wash of reflected sounds that follow the direct sound when heard inside a room or hall. It lends a feeling of distance and spaciousness to the overall sound, and makes it richer and more natural sounding. The material of the walls is simulated by the *reverb type* and the *reverb time*, and the degree of the after-reflections is determined by the *reverb level*.
- ★ The balance of the reverb sound for each Tone is set by the *reverb send level* of each Tone. The greater the send level, the greater the ratio of the reflected-sound of the Tone to the reflected-sound of the entire sound.
- ★ An *echo effect* can be produced by selecting delay for the reverb type. The *feedback level* lets you set the number of delayed repeats that occur as the sound decays. The delay continues until the level decreases to 0.

When Reverb is selected :

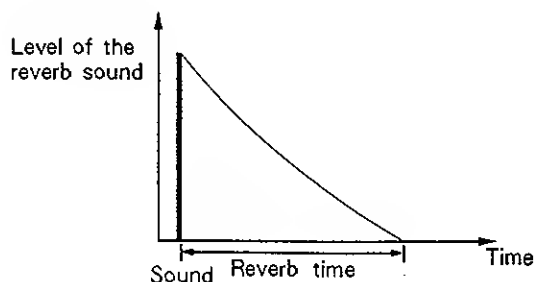

When Delay is selected :

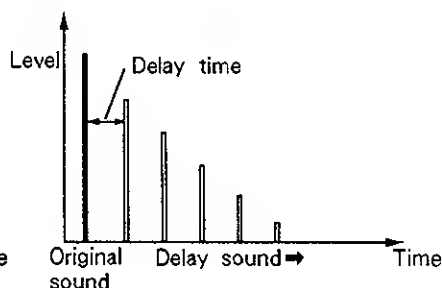

EFFECT

- ★ You can create a sound in which the level of the effect applied to a Tone is greater than the level of the Tone itself, since the level of the original unprocessed sound (*dry level*) can be set independently from the effect (or processed) sound. An interesting sound can be created by setting the dry level of the Tone used for the sustain or release portion of a Patch to 0.
- ★ The ratio of the effect sound of each Tone to the whole effect sounds is controlled by the chorus send level and the reverb send level. You can set the sound level of the unprocessed effect by using the dry level parameter.

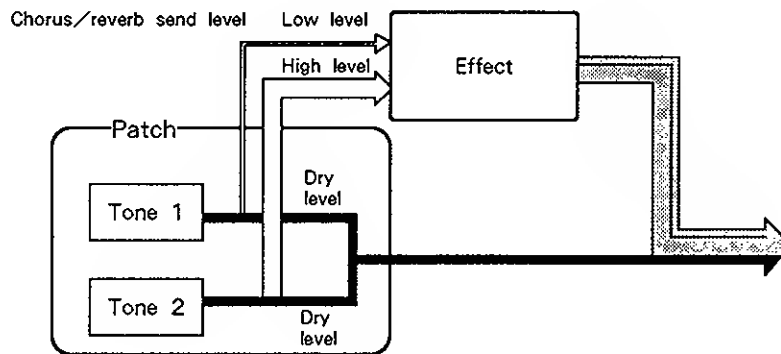

- ★ Chorus/reverb is used to apply effects to the Tone, and the *Analog Feel* parameter applies the *1/f modulation* at a point just following the generation of the original waveform. The *1/f modulation* includes special types of modulation such as the murmur of a little stream or the rustling sound of a gentle breeze. The JV-80 lets you add a natural feeling to the sound by taking advantage of this effect.

FX SEND (Effect Send) Page

```

1--- | Dry | Chorus | Reverb |
FX SEND ↓ | 127 | 45 | 80 |-----

```

Dry *Dry Level* Range: 0—127

This determines the level of the direct or unprocessed sound (the sound with no effect applied). If you are not applying an effect to the Tone, you should set this parameter value to 127, and adjust the sound volume from the Tone Level parameter of the TVA.

Chorus *Chorus Send Level* Range: 0—127

This determines the level of the signal sent to the chorus.

Reverb *Reverb Send Level* Range: 0—127

This determines the level of the signal sent to the reverb.

PATCH CHORUS Page

```

PATCH #Type | Lev | Rat | Dep | Fbk | Out | |
CHORUS #CHO1 | 100 | 60 | 20 | 0 | MIX | -- | ---

```

Type *Chorus Type* Settings: CHO 1—3

This determines the type of chorus.

CHO1	Normal chorus
CHO2	Chorus with a slow rate. This also makes a good flanger effect when feedback is applied.
CHO3	Chorus with pronounced depth. This applies substantial detuning to the sound.

Lev *Chorus Level* Range: 0—127

This determines the level or volume of the chorus sound. The greater the value, the greater the level.

Rat *Chorus Rate* Range: 0—127

This determines the speed of the modulation of the chorus sound. The greater the value, the faster the modulation.

Dep *Chorus Depth* Range: 0—127

This determines the depth of the modulation of the chorus sound. The greater the value, the deeper the modulation.

Fbk *Chorus Feedback* Range: 0—127

This determines the level of the re-routed (feedback) chorus sound. A richer, more complex chorus effect can be gained by boosting this parameter.

※ When the value of Fbk is low, the sound may sometimes be distorted.

EFFECT

Out *Output Switch* Settings: MIX/REV

This determines the destination of the chorus sound output. When set to MIX, the chorus sound and the reverb sound are mixed with the dry sound; when set to REV, the chorus sound is mixed with the dry signal after reverb is applied.

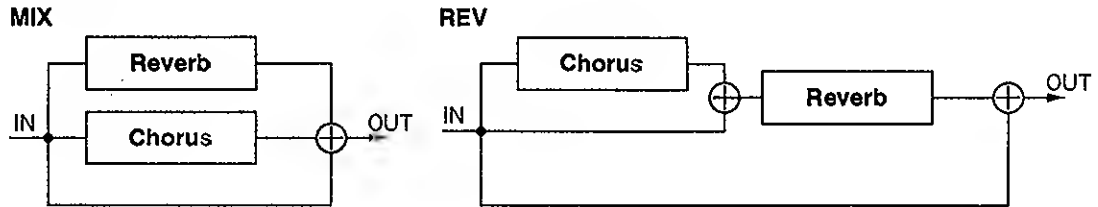

PATCH REVERB Page

PATCH	#	Type	Level	Time	F-Back
REVERB	#	ROOM1	100	60	20

Type *Reverb Type* Settings: ROOM 1 — 2/STAGE 1 — 2/HALL 1 — 2/DELAY/PAN-DLY

This determines the type of reverb.

ROOM1	Reverb with short and dense reverberant wash
ROOM2	Reverb with short and sparse reverberant wash
STAGE1	Reverb with strong reverberant wash in the final portion of the sound
STAGE2	Reverb with strong initial reflections
HALL1	Reverb with clear echo
HALL2	Reverb with rich echo
DELAY	Conventional delay
PAN - DLY	Deley in which the reflected sound pans left and right

Level *Reverb Level* Range: 0 — 127

This determines the level or volume of the reverb sound. The greater the value, the greater the level.

Time *Reverb Time* Range: 0 — 127

When ROOM 1 — HALL 2 is selected as the reverb type, this determines the time of the reflected-sound; when DELAY/PAN-DLY is selected, this determines the delay time.

When Reverb is selected :

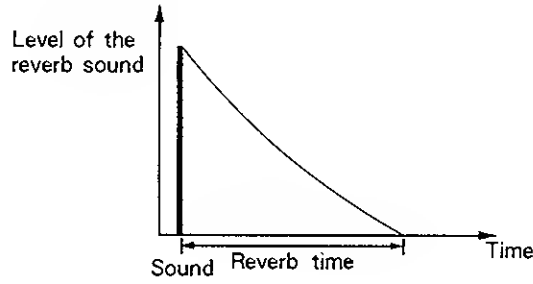

When Delay is selected :

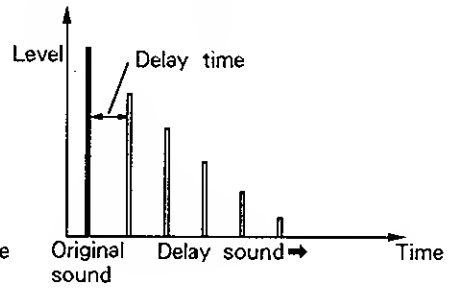

F-Back *Delay Feedback* Range: 0 — 127

When the type is set to DELAY, this determines the re-routed level (feedback) of the delay sound in the delay effector. Increasing this setting creates an echo effect of distinct multiple repeats of the sound.

ANALOG FEEL Page

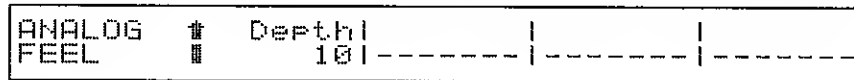

Depth *Depth* Range: 0 — 127

This determines the depth of the Analog Feel effect. Since it adds a special modulation, called **1/f modulation** to the level (volume) and to the pitch, a natural feeling can be given to the sound. The greater the value, the greater the modulation.

Parameters Selected by CONTROL (6 Pages)

The functions of the internal controllers are set from these pages.

★ *Assign Mode*

This determines whether Patches are set for *polyphonic* or *monophonic* play. When set to polyphonic, multiple voices of the Patches can sound at the same time, making it effective for playing chords. When set to monophonic, a single voice of each Patch sounds, and when several notes are played, only the first note pressed will sound. The monophonic setting is useful for simulating instruments that play single notes, and is even more effective when combined with the *Portamento* and *Legato* functions described below.

★ *Legato*

When one note is played using a certain Tone, while another note of a different Tone is being held down, the Tone changes from one note to the other (with the envelope and LFO of the first note continue without change). This makes it possible to accurately reproduce the hammer-on technique of guitar playing or make solo brass and strings sounds more authentic, especially when used with Portamento. This function is effective only when the JV-80 is in the Solo mode.

★ *Bend Range*

This sets the overall range that the pitch can be changed when the bender/modulation lever is moved to the left or right. Moreover, the pitch bend up range and pitch bend down range can be set to separate values. Bending pitch with the bender/modulation lever is an effective technique when used with sound programs such as guitars and sound effects.

★ *Portamento*

This function "slides" the pitch between successively played Tones. Effective and natural sounding solo guitar and solo brass lines can be played when Portamento is used in the solo mode. Portamento can also be applied in the polyphonic mode, and it is effective in simulating the slide techniques of the trombone and the gradual vocal pitch changes of a choir. If you set the Portamento mode to LEGATO, portamento is applied only when playing in legato.

★ *Pedal*

This enables (or disables) pedal control signals, including volume and Hold 1 (sustain), received via MIDI or from the JV-80 itself. By setting this on for individual Tones, it is possible to have the desired Tone sustain or change in volume.

★ *Modulation/Aftertouch/Expression Control*

Modulation, aftertouch and expression data, received via MIDI or from the JV-80 itself, can be used to control and change up to four different parameters for each Tone.

For example, it is possible to use aftertouch to increase both the volume of a Tone and the amount of vibrato applied to it. Another application would be to increase the depth of the growl effect on a Tone while decreasing the volume on another Tone. Using techniques like these enable you to more effectively simulate the particular performance styles of various musical instruments or the ensemble effect of an orchestra or band.

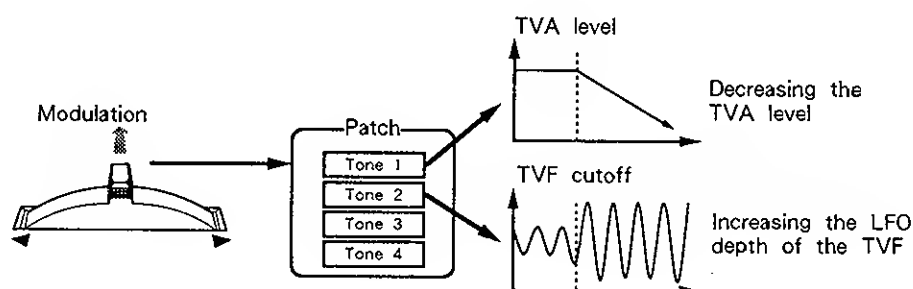

KEY ASGN & BEND RANGE (Key Assign and Bend Range) Page

KEY ASGN &	Assign	Legato	Bender-Range
BEND RANGE	POLY	OFF	-21 2

Assign *Assign Mode* Settings: POLY/SOLO

This determines whether the Patch sounds polyphonically (POLY) or monophonically (SOLO). When set to POLY, chords can be played, and when set to SOLO, the Patch sounds only for the note which was last played.

Legato *Legato* Settings: ON/OFF

This determines whether the Legato function is (ON) or (OFF). When this is set to ON, it will function in the following way: When a key of a certain note is held while another note is played, only the pitch changes while the envelope and LFO remain unchanged.

※ Legato is not effective when the assign mode is set to POLY, even if the Legato parameter is set to ON.

Bender-Range *Bender Range* Range: - 48 — 0 (down)/0 — 12 (up)

This parameter is set in two parts, down and up, and together they determine the range of the pitch bend effect (given in semitone units). Pitch is bent downwards by pushing the bender lever to the left, and bent upwards by pushing it to the right. When both the up and down values are set to 0, the pitch does not change even when the bender lever is moved.

CONTROL**PORTAMENTO** Page

PORTA-	↑	Switch1	Model	Type1	Time
MENTO	↓	OFF1	NORMAL1	Time1	10

Switch *Portamento Switch* Settings: ON/OFF

This determines whether the Portamento effect is (ON) or (OFF). When this is set to ON, portamento is applied and the pitch moves smoothly between the pitches of successive notes played.

Mode *Portamento Mode* Settings: LEGATO/NORMAL

This determines how the Portamento effect is applied. When this is set to NORMAL, Portamento is always on. When set to LEGATO, Portamento is applied only when notes are played in a legato manner (i.e., releasing one key only after the second key has been pressed).

Type *Portamento Type* Settings: TIME/RATE

This determines the type of Portamento effect. When this is set to TIME, the length of the time it takes to move from one note to the next is constant, regardless of the pitch interval between the two notes. When this is set to RATE, the time it takes to move from one note to the next depends on how large the pitch interval is between the two notes.

When set to TIME :

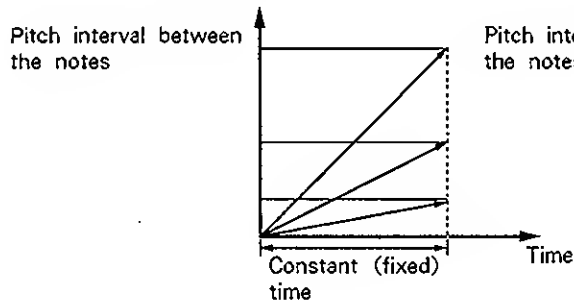

When set to RATE :

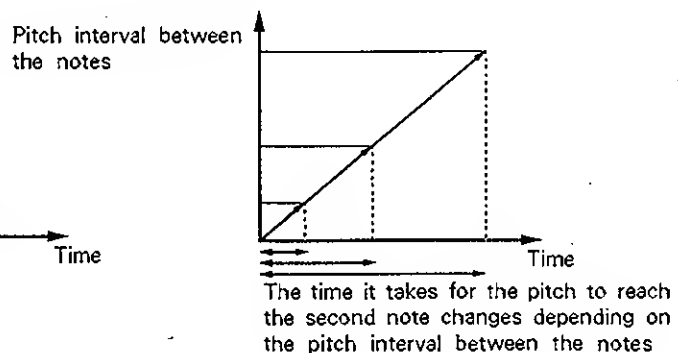
**Time** *Portamento Time* Range: 0 — 127

This determines the time it takes for the pitch to shift between two successively played notes when using the Portamento effect. The greater the value, the slower the speed.

PEDALS Page

```

1---  ↑ Volume| Hold-1|
PEDALS ↓ OFF| ON|-----|-----

```

Volume *Volume Control Switch* Settings: ON/OFF

This determines whether the Tone receives MIDI volume data or not. When this is set to ON, the Tone volume changes according to changes in the MIDI volume data.

Hold-1 *Hold 1 Control Switch* Settings: ON/OFF

This determines whether the Tone receives the Hold 1 MIDI data or not. Sustain can be applied via Hold 1 MIDI data when this is set to ON.

※ The MIDI standard uses control change number 7 for the volume and number 64 for Hold 1.

CONTROL Pages

The following three display pages let you select the Tone parameters for control and the degree to which the control change data affects these parameters for each Tone.

```

1---  ↑ Modulation(Destination:Depth)
CONTROL ↓PCH1+12|AL21-12|RES1 0|LEV1 0

```

Modulation Control *Modulation Control*

Up to four Tone parameters can be set for simultaneous control by modulation.

```

1---  ↑ Aftertouch(Destination:Depth)
CONTROL ↓PL11+12|PL21-12|FL11 0|FL21 0

```

Aftertouch Control *Aftertouch Control*

Up to four Tone parameters can be set for simultaneous control by aftertouch.

```

1---  ↑ Expression(Destination:Depth)
CONTROL ↓AL11+12|AL21-12|L1R1 0|L2R1 0

```

Expression Control *Expression Control*

Up to four Tone parameters can be set for simultaneous control by the expression pedal.

The assignable Tone parameters and the range for each are shown in the chart below.

CONTROL

Dest (Destination, or the parameters which can be controlled)		Depth (adjustable range)	Comments
Display indication	Meaning		
PCH	Pitch (in semitone units)	- 63 — + 63	When set to a positive value (+), the change is greater or higher, and when set to a negative value (-), the change is smaller or lower.
CUT	Cutoff frequency	- 63 — + 63	
RES	Resonance	- 63 — + 63	
LEV	Level (volume)	- 63 — + 63	
PL1	Depth of LFO 1 which is applied to pitch	- 63 — + 63	The phase of the LFO is reverse for positive (+) and negative (-). For both positive and negative settings, the effect becomes more pronounced as the value is set further from 0.
PL2	Depth of LFO 2 which is applied to pitch	- 63 — + 63	
FL1	Depth of LFO 1 which is applied to cutoff	- 63 — + 63	
FL2	Depth of LFO 2 which is applied to cutoff	- 63 — + 63	
AL1	Depth of LFO 1 which is applied to volume	- 63 — + 63	
AL2	Depth of LFO 2 which is applied to volume	- 63 — + 63	
L1R	Rate of LFO 1	- 63 — + 63	For positive values (+), the LFO frequency is high (fast), and for negative values (-), the frequency is low (slow). (Also see the chart below.)
L2R	Rate of LFO 2	- 63 — + 63	

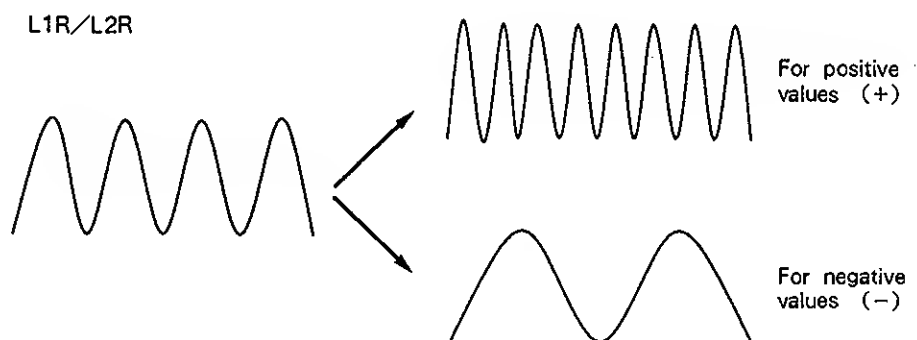

- ※ The MIDI standard defines control change number 11 for the expression pedal and number 1 for modulation. Aftertouch is defined separately from control change data. In the case of the JV-80, pushing the lever forward transmits modulation signals; for pedals 1 and 2, and the C1 slider, the signals which were assigned beforehand are transmitted. (Refer also to the MIDI implementation chart.)

Parameters Selected by **WAVE/LFO** (7 Pages)

These display pages let you select the waveform the basic building block for the sound and make LFO settings.

★ *Waveform*

The JV-80 is particularly well suited for recreating the complex sounds of actual musical instruments. Take, for example, the sound of an acoustic piano. We know that the piano sound is basically made by the vibration of the strings. However, if we listen more closely, we find that the overall sound is fairly complex and made up also of the percussive sounds of the hammer hitting the strings, the sympathetic vibration of the other strings and the resonance of the body of the piano itself. In the JV-80, by assigning all these sounds to several different Tones, we can create a much richer and realistic sound. Even when creating unique sounds that have no counterparts among actual instruments, you can give those sounds added depth and "realism" by crafting them with component striking or plucking sounds and sympathetic vibration sounds.

The JV-80 not only has waveforms for making the basic sounds, but also "one-shot" waveforms which can be used for the attack portion of the sound, loop waveforms, which are useful for sound effects, and rhythm waveforms which are especially for creation of drum and percussion sounds. They can be called up from the internal memory, optional PCM cards and expansion boards.

★ *Tone Switches*

These allow you to turn the sound of individual Tones on and off. In order to save simple sound programs and set the number of voices that sound, we suggest that you use these switches to turn off Tones that are not being used.

★ *Processing the Waveforms*

The JV-80 also provides waveform processing that lets you create a nearly unlimited variety of waveforms having even greater complexity. The processing method is called *FXM (Frequency X-Modulation)*, and new waveforms can be created by mixing (or cross-modulating) two waveforms. This is ideal for creating unusually dynamic and sharp sounds.

★ *Modulation and Vibration of Sound*

Many of the sounds in nature and the sounds of acoustic musical instruments have their own unique modulation or vibration. For example, the sound of a bell has a natural modulation, and notes on a violin are often played with vibrato. By varying the pitch, cutoff frequency and/or level with the LFO, instrument sounds can be made more natural and authentic. Besides these subtle techniques, it is also possible to use the LFO to radically change the character of the sound. The JV-80 has two independent LFO systems for each Tone.

Waveform: Available waveforms are triangle wave, sine wave, sawtooth wave, square wave, and random waves 1 and 2. In order to add modulation and vibrato, select the sine wave or triangle wave, and apply it in small degrees to the level (volume) and the pitch. The random waveforms are useful in creating special sound effects and modulation.

Syncro: When this is set to ON, the LFO starts independently for each key pressed (key on), making a richly textured mix of sounds when playing chords. This is ideal for adding realism to an ensemble effect, reproducing the natural lag between the start of vibrato for each instrument in a band or orchestra.

WAVE/LFO

Offset: This shifts the waveform of the LFO toward either (+) or (-). If it is shifted to the + side (- side), the center of the vibration of the sound becomes higher (bigger) or lower (smaller) than the original pitch or sound volume. For example, you can create automatic trills by setting the offset of the square waveform to +100 or - 100, and applying it to the pitch with an appropriate depth setting.

Delay: This allows you set a delay so that the LFO starts a certain time after the key has been played (key on).

Fade: This determines the time change from when the LFO is first applied until it reaches the depth that is set by the depth parameter.

Rate: This determines the vibration speed of the LFO.

You should use delay when you don't want to have the LFO to start at the same time as the sound itself starts, or when you want to simulate the sound of an actual musical instrument in which vibrato is usually applied after the sound starts. In such a case, the depth of the vibration can be made to gradually increase by using the fade time settings, letting you create natural vibrato and tremolo effects. Also, setting the rate to low values creates vibrato and tremolo effects, while higher values create a vague and distorted sound.

Depth: This determines the vibration depth of the LFO.

The way of changing the pitch and sound volume are reversed, when the value of depth is (+) and (-). For example, the phase of the modulation becomes reversed when setting the depth to a positive value (+) for one Tone, and setting the same amount of the depth on the negative (-) side for another Tone. By using this operation, different Tones can be sounded alternately, and the sounds can be moved back and forth over the stereo image in combination with the pan function (explained below). You can create a bell-like effect if you set the depth of the saw waveform of the offset to 100 with the (-) value as the level and cutoff.

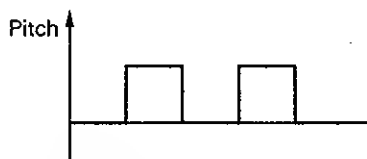

Make the following pitch modulation settings to the continuous portion of the sound

Waveform: Square wave
Offset: - 100
Depth: +1

By using the above settings, a semitone trill will be produced.

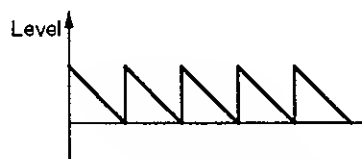

Make the following TVA modulation settings to the continuous portion of the sound

Waveform: Square wave
Offset: +100
Depth: - 63

By using the above settings, the sound will ring out continuously like a bell.

WAVE Page

```

1---  # Switch|Group| No  1
WAVE  #   ON| INT| 1(Ac Piano 1 )

```

Switch *Tone Switch* Settings: ON/OFF

This determines whether the Tone currently selected is used (ON) or not (OFF). The voice is used only for the Tone which is turned on.

Group *Wave Group* Settings: INT/EXP/CARD

This determines the type of waveform memory that is to be used. The JV-80 has 129 internal waveforms. The waveforms in the optional expansion (EXP) board and PCM cards (CARD) can be also used.

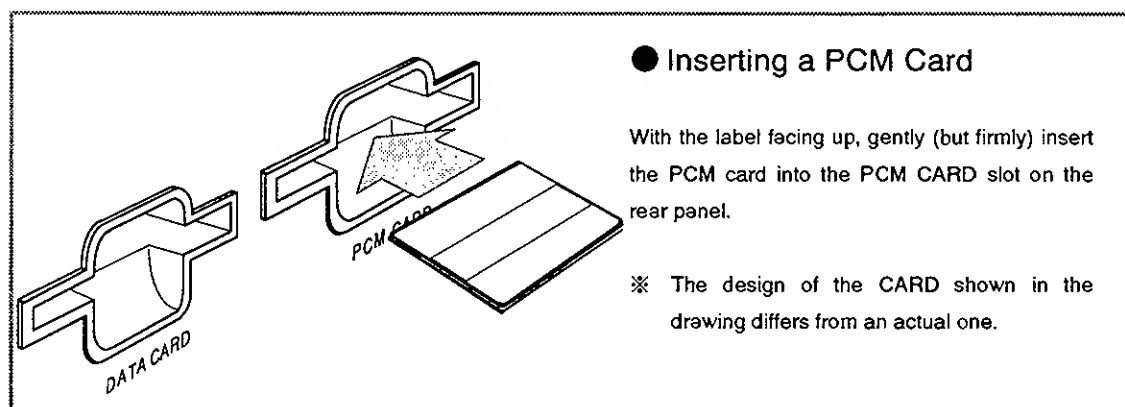
**No** *Wave Number*

This determines the number of the waveform to be used. The wave name of the set wave number is displayed in parentheses () in the display.

※ Only readable memory marks are displayed in the LCD.

FXM Page

```

1---  # Switch| Depth|
FXM  #   ON|   3|-----|-----

```

Switch *FXM (Frequency X-Modulation) Switch* Settings: ON/OFF

This determines whether the FXM function is on (ON) or not (OFF).

Depth *FXM depth* 1 — 16

This determines the depth of the FXM function.

WAVE/LFO

LFO 1/2 Pages

The LFO 1 and 2 settings are made from these four pages. (Parameters for both LFOs are identical.)

LFO 1	1---	▲	Form	Synchro	Rate	Offset
	LFO 1	▼	TRI~	OFF	40	0
LFO 2	1---	▲	Delay	Fade	Time	-----
	LFO 2	▼	20	INI	45	-----
LFO 1	1---	▲	Form	Synchro	Rate	Offset
	LFO 2	▼	RND~	ON	20	0
LFO 2	1---	▲	Delay	Fade	Time	-----
	LFO 2	▼	KEY-OFF	INI	20	-----

Form LFO Waveform Settings: TRI/SIN/SAW/SQR/RND1—2

This parameter lets you select from the available waveforms: triangle wave, sine wave, sawtooth wave, square wave, and random waves. A mark indicating the shape of the waveform is displayed along with the name in the LCD.

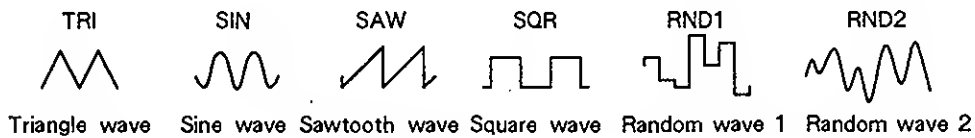

Synchro LFO Synchro Settings: ON/OFF

When this is set to ON, the LFO phase is synchronized with the key on data, allowing a separate LFO phase for each note that is played. When set to OFF, the phase of the LFO is unified for all notes played.

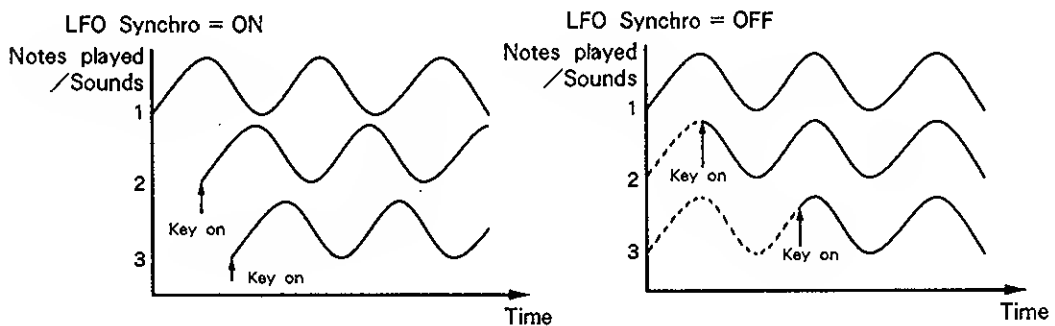

Rate LFO Rate Range: 0—127

This determines the speed of the LFO. The greater the value, the faster the speed.

Offset *Offset* Settings: -100/-50/0/+50/+100

This determines the ratio of how much the waveform of the LFO is shifted toward the positive (+) side or the negative (-) side.

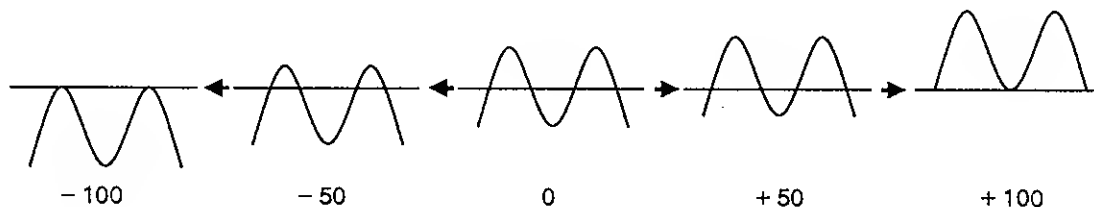
**Delay** *LFO Delay Time* Range: 0 — 127/KEY-OFF

This determines the time that elapses between the start of the Tone's sound (key on) and the start of the LFO. The greater the value, the greater the delay before the LFO is applied. Setting this to KEY-OFF applies the LFO only after the key is released.

Fade *LFO Fade Mode* Settings: IN/OUT

This determines the time over which the LFO is applied. When this is set to IN, the LFO is applied gradually after the key on data, according to the set LFO fade time (explained below). When set to OUT, the LFO is applied from the key on until the end of the delay time, and then gradually fades out according to the set fade time.

Time *LFO Fade Time* Range: 0 — 127

This determines the time of the fade in (or the fade out) of the LFO. The greater the value, the longer the time of the fade.

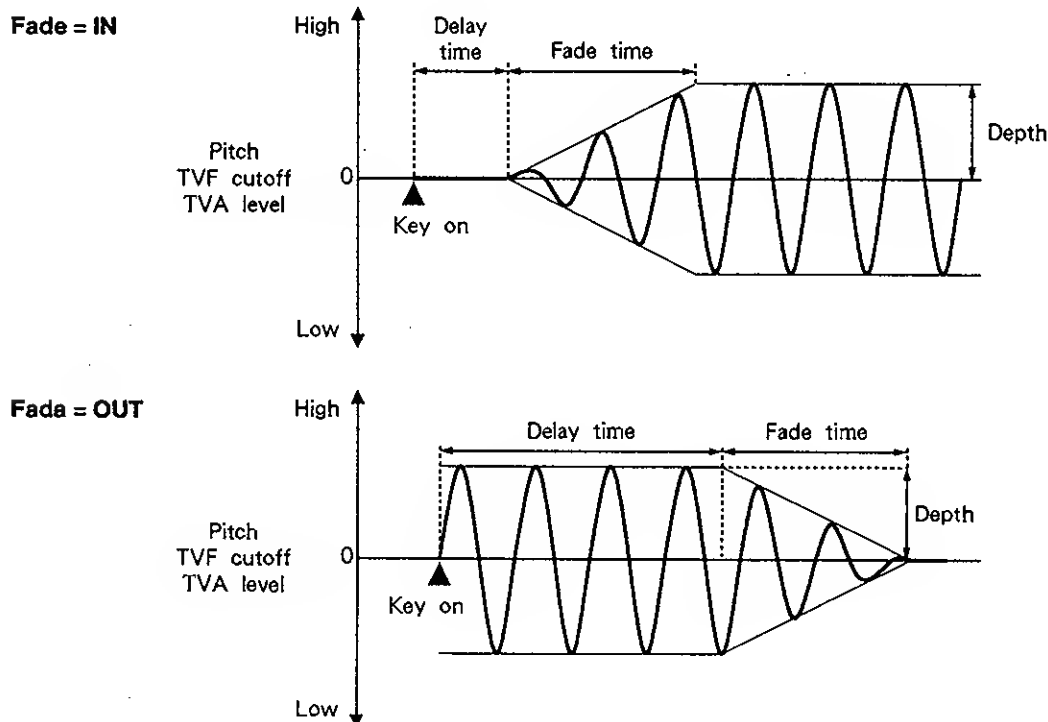

WAVE/LFO

LFO DEPTH Page

1---	LFO↑	P1	P2	F1	F2	A1	A2		
DEPTH		-10	+10	-30	+30	-20	+20	--	--

P1 P2 *Pitch LFO 1 Depth, Pitch LFO 2 Depth* Range: - 63 — +63

This determines the depth of LFOs 1 and 2, as applied to the Tone pitch. The further the value is set from 0, the more pronounced the variation in pitch.

F1 F2 *Filter LFO 1 Depth, Filter LFO 2 Depth* Range: - 63 — +63

This determines the depth of LFOs 1 and 2, as applied to the Tone cutoff frequency. The further the value is set from 0, the more pronounced the “growling” sound of the filter sweep.

A1 A2 *Level LFO 1 Depth, Level LFO 2 Depth* Range: - 63 — +63

This determines the depth of LFOs 1 and 2, as applied to the Tone level. The further the value is set from 0, the more pronounced the tremolo (swell) effect.

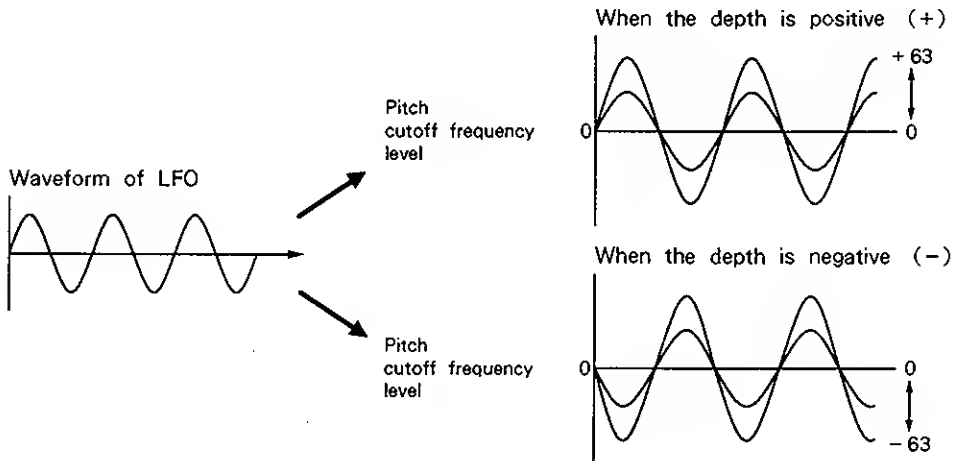

Parameters Selected by **PITCH** (3 Pages)

Pitch related parameters of the Tone are set on this page.

★ *Pitch Shift Coarse/Fine*

This determines the basic pitch or tuning at which notes will sound. Coarse and fine tuning controls are also available in the Performance settings, but the parameters in this section are separate controls used for creating the basic sounds. For example, you can use these controls to slightly detune the pitch of two Tones relative to each other to create a chorus effect, making the sound thicker and more animated. It is also possible to create a chord by playing one key if the pitch coarse parameter of more than two Tones are set appropriately.

- ✘ Keep in mind that using these controls changes the pitch that you hear, but has no effect on the key number of the keyboard. Therefore, the key range position and the key number data transmitted via MIDI OUT are the same regardless of the setting of these pitch coarse/line parameters.

★ *Random Pitch*

Since, this randomly detunes the pitch for each note played, it is particularly effective for reproducing the sound of a fretless stringed instruments and percussion instruments.

★ *Pitch Key Follow*

The pitch of the JV-80 is changed according to the range in which keys are played. The key C4 is the center (or 0) and the pitch variation increases as you move away from C4. Therefore, the pitch for C4 is the same regardless of the key follow setting. Normally, the key follow parameter should be set to 100.

A key follow setting of 0 results in no pitch change, or all keys playing the same pitch. This setting is useful for producing transient sounds, like that of the hammers on piano strings.

★ *Envelope*

This makes changes in the pitch over time, within the range set by the depth parameter. If you find that the pitch doesn't change as much as you want it to, even when the envelope is set to a high value, you can increase the depth. On the other hand, when you want to set the pitch to change in minute gradations, even though the pitch change itself is narrow, set the depth to a low value.

When simulating the sound of a human voice or choir, a more realistic sound can be obtained by making the initial pitch slightly lower than the main pitch. These parameters can also be used to imitate acoustic wind instruments like the Japanese shakuhachi, the pitch of which often fluctuates according to the player's blowing technique.

★ *Envelope Time Key Follow/Velocity Sensitivity*

These parameters allow you to control how the time of the entire envelope changes according to the key position (the standard or center key is C4) or the playing strength.

This is useful for changing the pitch by key range or playing strength, especially when simulating tuned percussion instruments.

PITCH

PITCH Page

```

1---  | Crs | Fin | Rnd | P-KF | Env | Vel | |
PITCH  #  01  01  01  01  01  01  --|--
    
```

Crs *Pitch Shift Coarse* Range: -48 — +48

This offsets the pitch of the Tone in semitone units. The pitch is shifted higher than normal when the value is positive (+), and is shifted lower when the value is negative (-).

Fin *Pitch Shift Fine* Range: -50 — +50

This offsets the pitch of the Tone in units of 1/100 of a semitone. The pitch is shifted higher than normal when the value is positive (+), and is shifted lower when the value is negative (-).

Rnd *Random Pitch Depth* Settings: 0/5/10/20/30/40/50/70/100/200/300/400/500/600/800/1200

The pitch of the Tone is shifted over random amounts within the range set here. The value is expressed in units of 1/100 of a half-step.

P-KF *Pitch Key Follow*

Settings: -100/ -70/ -50/ -30/ -10/0/+10/+20/+30/+40/+50/+70/+100/+120/+150/+200

This determines how the pitch of the Tone changes according to the key position. At a setting of +100, the pitch change over 12 keys is the normal one octave. C4 key as a standard of reference, when the pitch key follow is set to a positive (+) value, the larger the note number, the higher the pitch; also, the greater the value, the greater the pitch difference between successive notes. When the value is negative (-), the pitch difference is smaller.

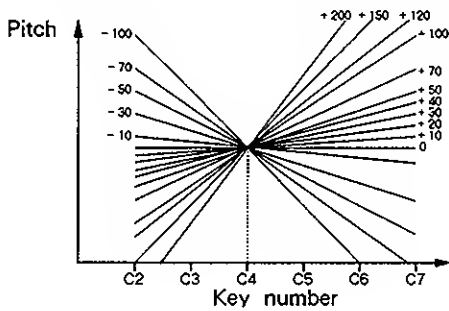

Env *Pitch Envelope Depth* Range: -12 — +12

This determines the maximum change rate of the pitch of the Tone according to the level of the envelope. When the depth is positive (+), the greater the level of the pitch envelope, the higher the pitch. When the depth is negative (-), the greater the level of the envelope, the lower the pitch.

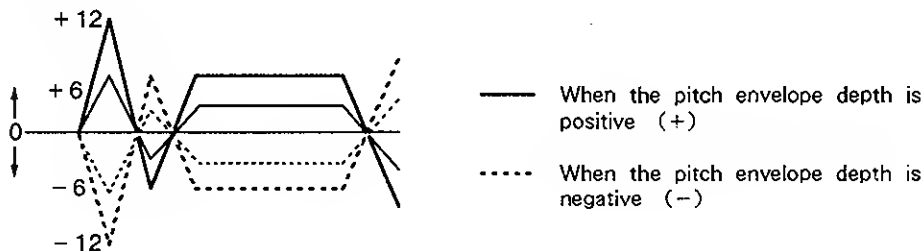

Vel *Velocity Envelope Level Sensitivity* Range: -63 — +63

This determines how the level of the pitch envelope changes according to velocity. When the value is positive (+), the greater the velocity, the greater the level. When the value is negative (-), the lesser the velocity, the greater the level.

P-ENV (Pitch Envelope) Pages

These two pages allow you to set how the pitch changes over time (pitch envelope).

```

1---  #Velo-T1|Velo-T4|Time-KF|
P-ENV #   -50|   -50|   -70|-----

```

```

1---  # T1| T2| T3| T4| L1| L2| L3| L4
P-ENV #  5| 10| 30| 80|+63|-10| 0|+10

```

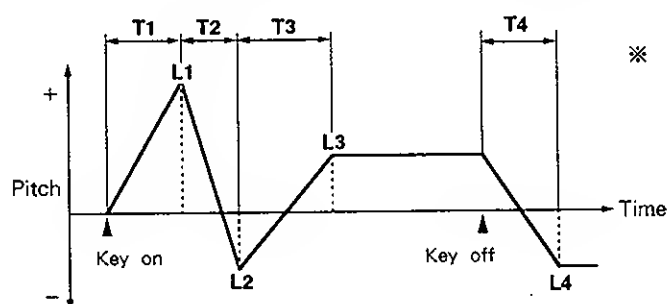
**Velo-T1** *Velocity Attack Time Sensitivity*

Settings: -100/-70/-50/-40/-30/-20/-10/0/+10/+20/+30/+40/+50/+70/+100

The T1 time of the pitch envelope can be changed by velocity. When the value is positive (+), the greater the velocity, the longer the time. When the value is negative (-), the shorter the time. No change results at 0.

Velo-T4 *Velocity Release Time Sensitivity*

Settings: -100/-70/-50/-40/-30/-20/-10/0/+10/+20/+30/+40/+50/+70/+100

The T4 time of the pitch envelope can be changed by key off velocity. When the value is positive (+), the greater the velocity, the longer the time. When the value is negative (-), the shorter the time. No change results at 0.

PITCH**Time-KF** *Envelope Time Key Follow*

Settings: -100/ -70/ -50/ -40/ -30/ -20/ -10/0/+10/+20/+30/+40/+50/+70/+100

The time of the pitch envelope can be made to change depending on the key position (key number). C4 key as a standard of reference, when the value is positive (+), the higher the key number, the shorter the time from T2 to T4. When the value is negative (-), the higher the key number, the longer the time. No change results at 0.

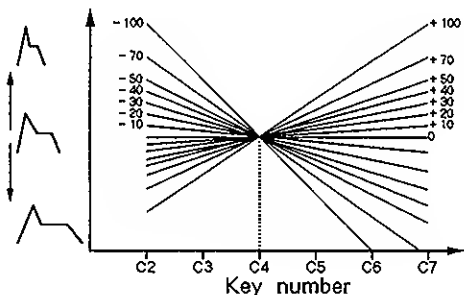
**T1 T2 T3 T4** Range: 0 — 127

These determine the time settings (T1, T2, T3 and T4) of the pitch envelope. Each setting represents the time it takes for the pitch to change from one point to the next; for example, T2 is the time it takes the pitch to change from L1 to L2. The greater the value, the longer the time it takes to reach the next level.

L1 L2 L3 L4 Range: -63 — +63

These parameters determine the level settings (L1, L2, L3 and L4) of the pitch envelope. They determine the amount by which the pitch is changed at each point. The standard pitch here is the same as the value set in the pitch shift coarse/fine parameters. When the value is positive (+), the pitch is higher than standard pitch. When the value is negative (-), the pitch is lower than standard pitch.

Parameters Selected by TVF (3 Pages)

The functions of the TVF are set in these pages.

★ *Filter Type and Cutoff Frequency*

Generally, the TVF is used to filter out, or “cut off,” the high frequency elements of a waveform, making what is called a low pass filter (LPF). The timbre of the sound becomes brighter when setting the cutoff frequency to high values, since high frequency elements are allowed to pass through. The opposite effect can be achieved by setting the cutoff frequency to a low value, filtering out the high frequency elements and making the timbre of the sound more mellow and closer to the pure quality of a sine wave. Increasing the level of the envelope turns the TVF type to a high pass filter (HPF), causing the timbre of the sound to change, but leaves the bright portion or sharp portion of the sound unchanged. For both types, the filter is applied around the cutoff frequency.

★ *Cutoff and Envelope*

The “normal” cutoff frequency, set in the cutoff parameter, is that frequency where the level of the envelope is 0. Therefore, the cutoff frequency increases or decreases according to changes in the envelope level.

★ *Resonance*

This creates a characteristic sound by emphasizing the frequency elements around the cutoff frequency of the TVF. It is effective in making sound programs which have a characteristic electronic or synthesizer-type sound, such as synth bass and synth lead.

The emphasized frequency changes along with the cutoff frequency, when the cutoff frequency is modulated by the envelope.

★ *Resonance Mode*

When the way that resonance is applied is set to SOFT, the sound has a subtle, moderately electronic feel. When set to HARD, the resonance is applied sharply and the timbre of the sound is drastically changed. It is recommended to set it to HARD when you want to reproduce dynamic resonance effects characteristic of analog synthesizers, like the resonance that results just before oscillation.

★ *Cutoff Key Follow*

These parameters let you change the cutoff frequency depending of the key position and velocity. Set the key follow value to less than 100 for piano sound programs, since the sound of an actual piano becomes softer the higher up on the keyboard you play. If you set different key follow values for each Tone, the way that the sound program changes becomes irregular.

★ *Envelope*

This makes changes in the cutoff frequency over time, within the range set by the depth parameter. If you find that the sound doesn't change as much as you want it to, even when the envelope is set to a high value, you can increase the depth.

The brightness and sharpness (high overtones or harmonics) of the sound of stringed instruments (e.g., harp and guitar) and of percussion (e.g., bells and vibraphone) gradually fade as the sound decays. To effectively reproduce these kinds of instruments, we suggest that you set the TVF envelope to its highest point at the beginning of the sound, then have it decrease gradually. On the other hand, you can obtain the opposite kind of effect for instruments like a gong, which increases in brightness as the sound sustains; to do this, have the TVF envelope gradually increase in level from key on.

TVF

★ *Envelope Time Key Follow/Velocity Sensitivity*

These parameters let you increase or decrease the envelope time and level depending on key position (the standard is C4) and playing strength. One typical application is to set the key follow to a value greater than 100 for sound programs of instruments that decay relatively quickly, to make the sound decay faster as higher notes are played. It is also common to set the velocity level sensitivity to a high value so that the brightness of the sound increases dramatically as the keys are played strongly similar to the way the sound of a trumpet radically changes when it is overblown.

Since each Tone can be set independently, the sound programs are changed to become brighter depending on the key range and playing strength, if you set +/- value for each Tone.

TVF Page

```

1---  Typ|Cut|Res|Mod|F-K|Env| 1
TVF   #LPF|85| 0|SOFT|100|+63|--|--
    
```

Typ *Filter Type* Settings: OFF/LPF/HPF

This determines the type of TVF. LPF sets it to low pass filter operation, and HPF sets it to high pass filter. Filter operation is cancelled when set to OFF.

Cut *Cutoff Frequency* Range: 0 — 127

This determines the cutoff frequency, above or below which the TVF is applied for filtering out the specified frequency elements of the waveform. The greater the value, the higher the cutoff frequency.

Res *Resonance* Range: 0 — 127

This emphasizes the frequency elements of the waveform around the cutoff frequency. The greater the value, the stronger the resonance effect.

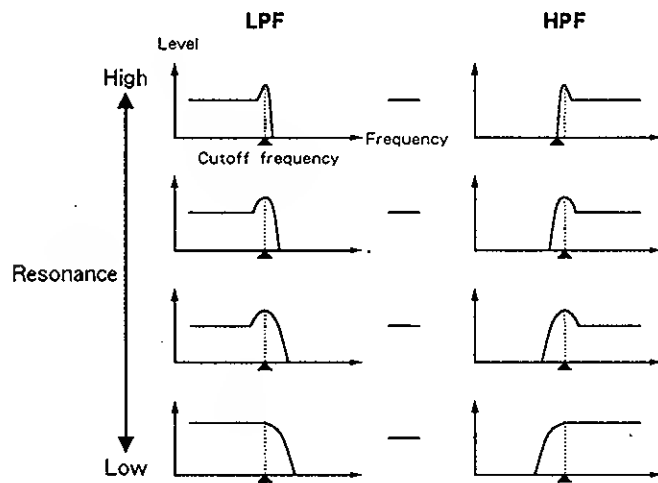

Mode *Resonance Mode* Settings: SOFT/HARD

This determines the type of resonance. When this is set to SOFT, the resonance effect is moderate; when set to HARD, the resonance effect is pronounced.

- ※ There are some cases in which the resonance effect decreases, such as when the Tone level is high when it sounds, or the cutoff frequency is high.

F-KF *Cutoff Key Follow*

Settings: -100/-70/-50/-30/-10/0/+10/+20/+30/+40/+50/+70/+100/+120/+150/+200

This parameter lets you change the cutoff frequency depending on the key position. At 100, the standard frequency of the sound becomes the cutoff frequency. C4 key as a standard of reference, when the value is positive (+), the higher the key number, the higher the cutoff frequency. When the value is negative (-), the higher the key number, the lower the cutoff frequency.

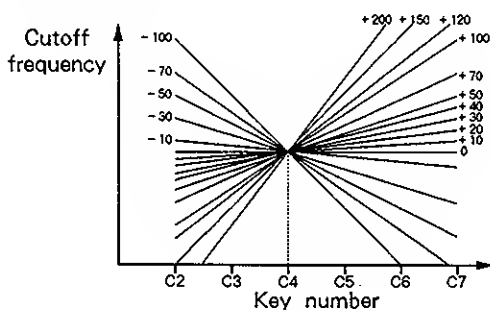
**Env** *TVF Envelope Depth* Range: -63 — +63

This determines the maximum range over which the envelope changes the cutoff frequency. When the value is positive (+), the greater the depth of the envelope, the higher the cutoff frequency. When the value is negative (-), the greater the depth of the envelope, the lower the cutoff frequency.

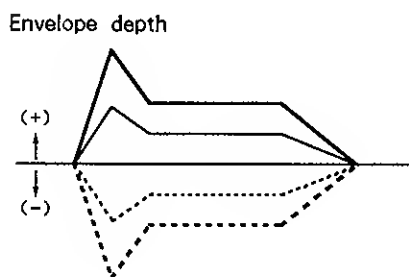

TVF

TVF ENV (TVF Envelope) Pages

These two pages let you set how the cutoff frequency changes over time (TVF envelope).

```

1---  #Crv|Vel|U-T1|U-T4|T-KF| | | |
TVF-ENV #3|/|+32| -40| 40| -30|--|--|
    
```

```

1---  # T1| T2| T3| T4| L1| L2| L3| L4
TVF-ENV # 10| 10| 50| 70|127|100| 85| 0
    
```

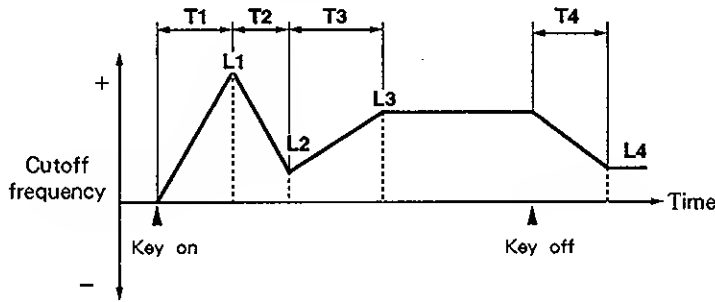

Crv Velocity Curve Type Settings: 1 — 7

This determines how different playing strengths affect the change in the cutoff frequency. The indications shown in the display, which show the shape of the curves, correspond to the curve type number.

Velocity curves

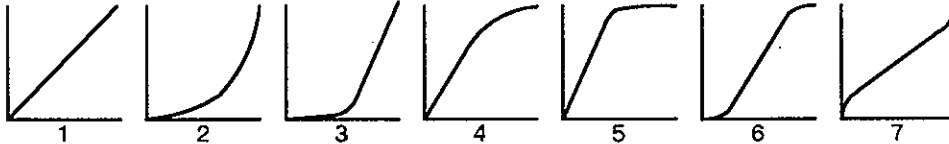

Vel Velocity Envelope Level Sensitivity Range: - 63 — +63

This allows you to change the TVF envelope level by velocity. When the value is positive (+), the greater the velocity, the greater the level. When the value is negative (-), the smaller the velocity, the greater the level.

V-T1 Velocity Attack Time Sensitivity

Settings: - 100/ -70/ -50/ -40/ -30/ -20/ -10/0/+10/+20/+30/+40/+50/+70/+100

The T1 time of the TVF envelope can be changed by velocity. When the value is positive (+), the greater the velocity, the longer the time of T1. When the value is negative (-), the shorter the time. No change results at 0.

V-T4 Velocity Release Time Sensitivity

Settings: - 100/ -70/ -50/ -40/ -30/ -20/ -10/0/+10/+20/+30/+40/+50/+70/+100

The T4 time of the TVF envelope can be changed by key off velocity. When the value is positive (+), the greater the velocity, the longer the time of T4. When the value is negative (-), the shorter the time. No change results at 0.

T-KF *Envelope Time Key Follow*

Settings: -100/-70/-50/-40/-30/-20/-10/0/+10/+20/+30/+40/+50/+70/+100

The time of the TVF envelope can be made to change depending on the key position. C4 key as a standard of reference, when the value is positive (+), the higher the key number, the shorter the time from T2 to T4. When the value is negative (-), the higher the key number, the longer the time. No change results at 0.

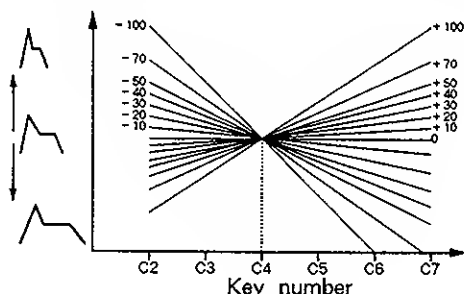
**T1 T2 T3 T4** Range: 0 — 127

These determine the time settings (T1, T2, T3 and T4) of the TVF envelope. Each setting represents the time it takes for the cutoff frequency to change from one point to the next; for example, T2 is the time it takes the cutoff frequency to change from L1 to L2. The greater the value, the longer the time it takes to reach the next level.

L1 L2 L3 L4 Range: - 63 — +63

These determine the level settings (L1, L2, L3 and L4) of the TVF envelope. They determine the cutoff frequency of each point. The values set here change the cutoff frequency after adjusting the degree applied from the TVF envelope depth parameter. The greater the value, the higher the cutoff frequency.

Parameters Selected by **TVA (4 Pages)**

Functions of the TVA are set in these pages.

★ *Level*

When creating a single sound program by using several Tones, you can change the volume balance to emphasize certain parts of the sound. We suggest that you set the level to the maximum value (127) when using only one Tone, or when you want several Tones to sound at the same volume. You can also adjust the volume in realtime as you play by using the appropriately assigned Parameter Slider.

★ *Level Key Follow/Velocity Curve*

This allows you to change the level by key position or velocity. We suggest that you set the key follow to a value between - 10 and - 30 to maintain a relatively even balance. This is because higher frequency sounds are perceived as being louder, even though the actual volume is the same throughout the keyboard range. Also, when setting the key follow parameters of the two Tones to 100 and - 100, the timbre of the sound changes as you play from the lower range of the keys to the higher range.

For recreation of musical instruments whose sound quality changes greatly depending on the playing strength and sound range, you can program a composite sound that changes greatly by using different Tones and assigning them to different key range or velocity zones.

★ *Pan Offset/Key Follow*

Pan offset determines the basic stereo position of the Tone, and key follow is used to set how the sound moves in the stereo position in response to key position.

When fixing the stereo image of the Tone, first set the key follow value to 0, then decide the stereo position. When creating the sounds of an ensemble, you can achieve a widely dispersed sonic effect in which the individual instruments or Tones are scattered left and right over the stereo field. The technique is also effective for piano sounds; set the offset value to 0 and the key follow to 100 to have the notes of the piano spread across the stereo field according to key position.

★ *Tone Delay*

This applies a delay to the start of the Tone after a key is pressed. You can create an echo effect by setting different delay times for the various Tones. Since this parameter is independent of the delay effect, the original and delayed sounds can be completely different sounds. You can also use this function to produce arpeggios with the touch of a single key by assigning different pitch settings for each Tone.

★ *Envelope*

Set the level so that it gradually decreases for sound programs like pianos, bells or guitars, whose volume decays fairly quickly over time. The L3 parameter should be set to a relatively high value for the sound programs which have a fairly steady, continuous sound, such as violin or clarinet. However, even though sounds like one-shot waveforms or rhythm waveforms are pre-programmed with their own level changes, the envelope effect is added to this original envelope.

Decaying sounds, like bells or a piano Continuous sounds, like a violin or clarinet

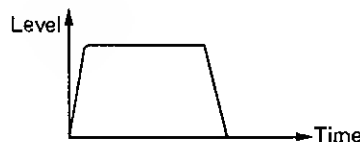

★ *Envelope Time Key Follow/Velocity Sensitivity*

These functions let you change the envelope time and level depending on key position (the standard is C4) and playing strength. To reproduce the sound of stringed instruments, we suggest that you set the key follow to a positive value (+) to make the sounds decay more quickly in the higher key ranges.

Another common technique is to set the velocity level sensitivity to a positive value (+), to increase the volume of the sound according to the playing strength. Another possible application is to set one Tone to -32 and another to $+32$ so that the sound itself changes according to playing strength.

TVA Page

```

1---  ||Lev|L-KF|Crv|Vel||Pan|P-KF|  |
TVA   #127| -10|3_/|+32| 0 |+100|---|

```

Lev *Tone Level* Range: 0 — 127

This determines the level (volume) of the Tone.

L-KF *Level Key Follow* $-100/-70/-50/-40/-30/-10/0/+10/+20/+30/+40/+50/+70/+100$

This parameter lets you change the level depending on the key position. When the value is positive (+), the higher the key number, the greater the level. Also, the greater the value, the steeper the curve. When the value is negative (–), the higher the key number, the lower the level. No change results at 0.

Crv *Velocity Curve Type* Settings: 1 — 7

This determines how different playing strengths affect the change in the level. The indications shown in the display, showing the shape of the curves, correspond to the curve type number.

Velocity curves

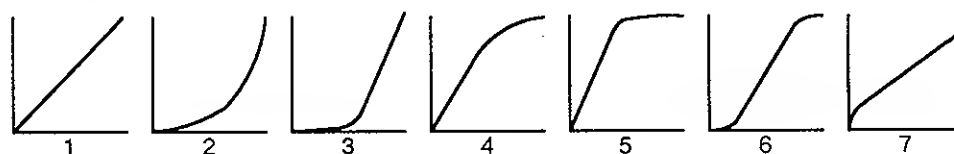

Vel *Velocity Level Sensitivity* Range: -63 — $+63$

This allows you to change the level by velocity. When the value is positive (+), the greater the velocity, the greater the level. When the value is negative (–), the smaller the velocity, the greater the level.

Pan *Pan* Settings: L64 — 0 — 63R/RND

This determines the stereo position of the Tone. The sound position is at the farthest left at L64, at the center at 0, and at the farthest right at 63R. When this is set to RND, the stereo position of the sound image changes randomly for each note played.

P-KF *Panning Key Follow*

Settings: -100/-70/-50/-40/-30/-10/0/+10/+20/+30/+40/+50/+70/+100

This determines how the sound moves in the stereo position in response to key position (key number). With the stereo position of the C4 key as the standard, when set to a positive value (+), the higher the key range played, the further right the sound is placed in the stereo position. When set to a negative value (-), the lower the key range played, the further right the sound is placed. For both positive (+) and negative (-) values, the further the value is from 0, the further the sound is placed toward the left or right. When this is set to 0, the stereo position of the sound image is fixed regardless of the key number.

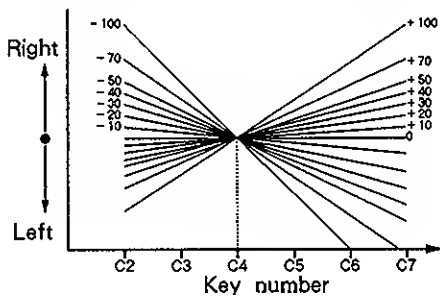

DELAY (Tone delay) Page:

```

1--- # Model Time |-----|
DELAY #PLAYMATE|KEY-OFF|-----|
    
```

Mode *Tone Delay Mode* Settings: NORMAL/HOLD/PLAYMATE

This determines the type of the Tone delay. When set to NORMAL, the Tone delay is effective even after the note is released. On the other hand, when this is set to HOLD, the Tone delay is applied only while the key is being pressed (during key on). Therefore, the Tone will not sound if the note is released before the delay time has elapsed. The PLAYMATE setting monitors the keyboard in applying the delay; the time from the first note on to the second note on becomes the delay time, if this time is less than two seconds.

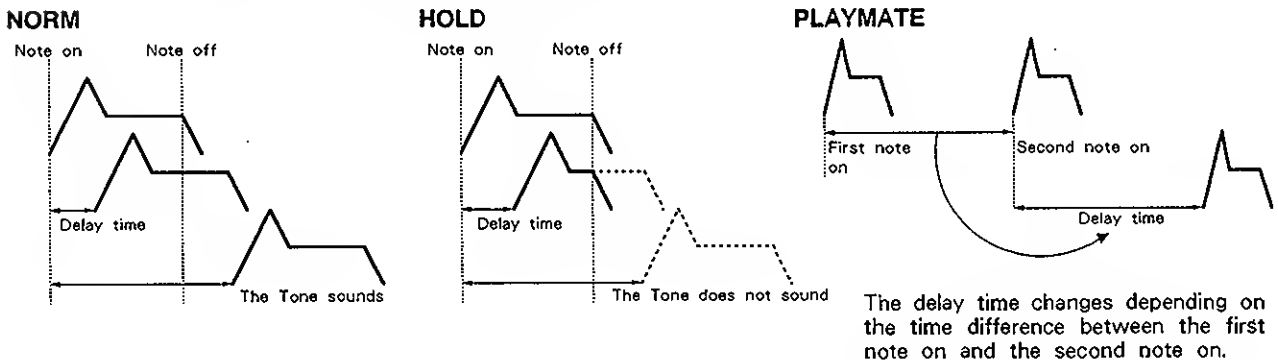

Time *Tone Delay Time* Range: 0 — 127/KEY-OFF

This determines the time that elapses from note on (playing of a key) until each Tone starts to sound. When the mode is set to PLAYMATE, the time from the first note on to the second note on becomes the delay time, if this parameter value is set to 64. When set to 127, the delay interval is approximately twice that of when set to 64. When set to KEY-OFF, the sound starts the moment the key is released (key off), regardless of the mode setting.

TVA-ENV (TVA Envelope) Pages

These two pages let you set how the volume of the sound changes over time (TVA envelope).

1---	↑	Velo-T1		Velo-T4		Time-KF		
TVA-ENV	↓	-20		-40		20		-----

1---	↑	T1		T2		T3		T4		L1		L2		L3		
TVA-ENV	↓	0		10		30		70		127		100		85		---

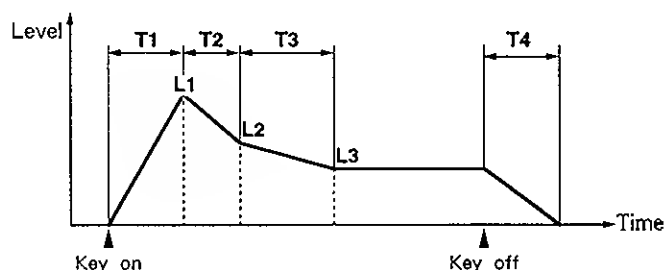
**Velo-T1** *Velocity Attack Time Sensitivity*

Settings: -100/ -70/ -50/ -40/ -30/ -20/ -10/0/+10/+20/+30/+40/+50/+70/+100

The T1 time of the TVA envelope can be changed by velocity. When the value is positive (+), the greater the velocity, the longer the time of T1. When the value is negative (-), the shorter the time. No change results at 0.

Velo-T4 *Velocity Release Time Sensitivity*

Settings: -100/ -70/ -50/ -40/ -30/ -20/ -10/0/+10/+20/+30/+40/+50/+70/+100

The T4 time of the TVA envelope can be changed by key off velocity. When the value is positive (+), the greater the velocity, the longer the time of T4. When the value is negative (-), the shorter the time. No change results at 0.

Time-KF *Envelope Time Key Follow*

Settings: -100/ -70/ -50/ -40/ -30/ -20/ -10/0/+10/+20/+30/+40/+50/+70/+100

The time of the TVA envelope can be made to change depending on the key position (key number). C4 key as a standard of reference, when the value is positive (+), the higher the key number, the shorter the time from T2 to T4. When the value is negative (-), the higher the key number, the longer the time. No change results at 0.

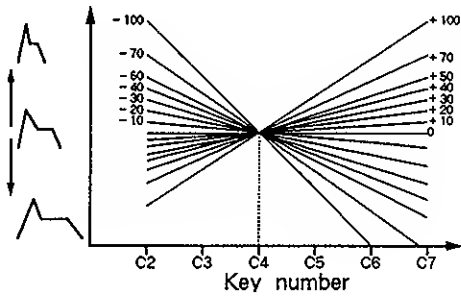
TVA**T1 T2 T3 T4** Range: 0 — 127

These determine the time settings (T1, T2, T3 and T4) of the TVA envelope. Each setting represents the time it takes for the level to change from one point to the next; for example, T2 is the time it takes the level to change from L1 to L2. The greater the value, the longer the time it takes to reach the next level.

L1 L2 L3 Range: 0 — 127

These determine the level settings (L1, L2, L3 and L4) of the TVA envelope. The greater the value, the greater the level. The envelope level becomes 0 after the key off in the case of the TVA.

2. Performance Edit

What is the Performance Edit mode?

The JV-80 can be played using several Patches together. Remember that the total sound of the instrument is made up of up to seven Patches and one Rhythm Set, and the conditions under which they are played. The structure of the Performance parameters is shown in the chart below.

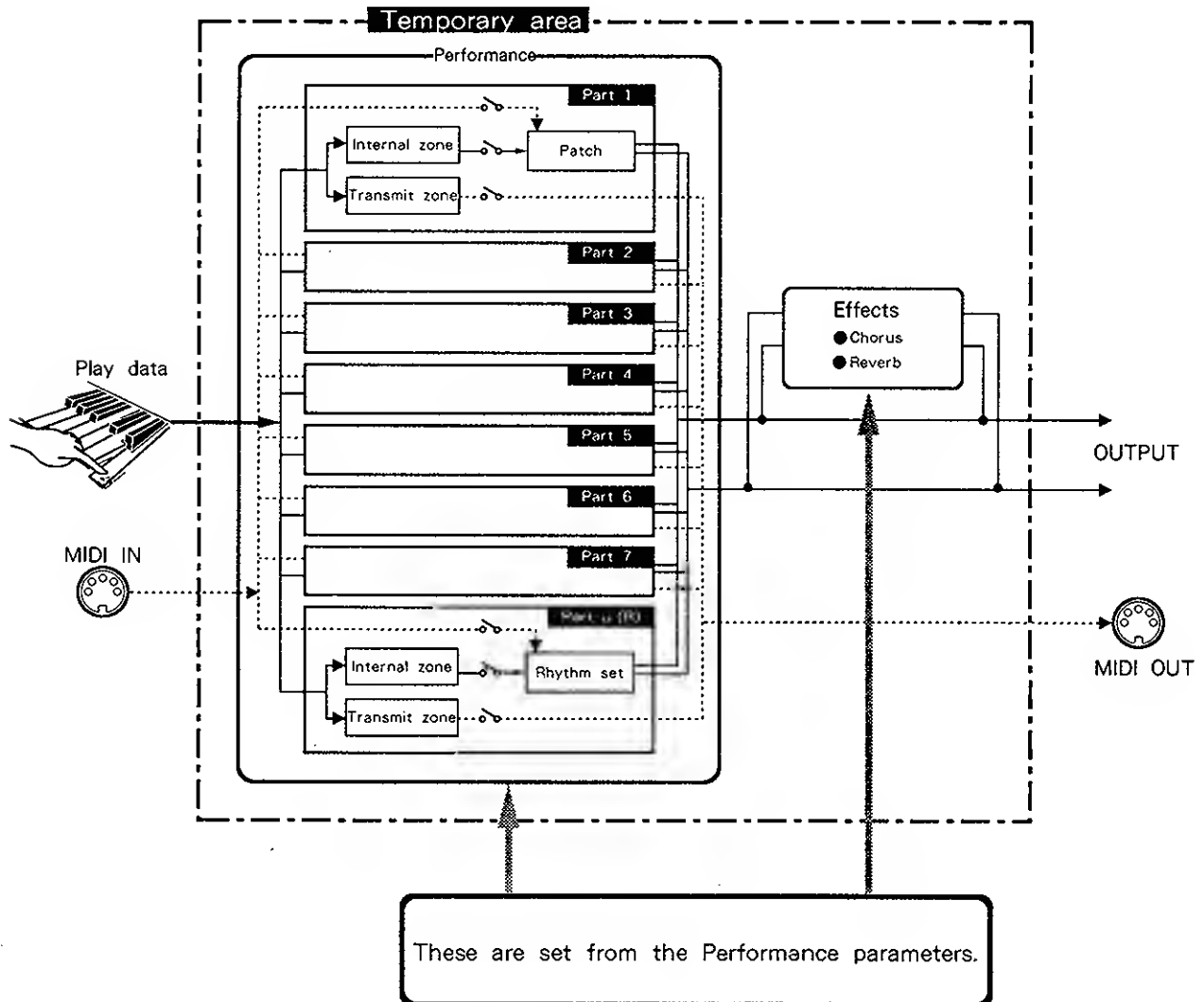

● Part

A Part is made up of seven Parts and one Rhythm Part. Patches are assigned to Parts 1 — 7, and a Rhythm Set is assigned to the rhythm Part. The sound is output according to performance data received via the internal zone (see below) and MIDI. The sound of the entire Performance is determined by adjusting the relative level and pan settings of the Patches.

● Internal Zone

The internal zone processes the performance data from the internal device (the controllers of the JV-80) and sends it to the Patch. The Patches assigned to the Parts sound according to the performance data received. The way you play the JV-80 can be “split up” to generate separate ranges and types of performance data, depending on the how each zone is set up to process the data.

● Transmit Zone

The transmit zone processes the performance data from the internal device and transmits it over the set MIDI channel. Since program change and volume data are transmitted from each zone when a Performance is called up, the connected external MIDI sound sources effectively become part of the Performance of the JV-80. Using the terminology of the internal sound sources, the MIDI transmit channel would be the same as the Part, and the sound program of the external sound source would be the Patch.

● Effects

The settings of the internal effect section make up one group that affect a single Performance, and it is applied equally to all Parts of the Performance. The depth of the effect applied to each Part depends on the send level parameter, which is set for the Patch. However, the effect settings made in the Patch play mode, for the Patch itself, are ignored.

How to edit a Performance

- After selecting the Performance to be edited, press **PERFORMANCE EDIT**. Then press one of the Function Select buttons to call up the desired Performance parameter.
(The letters printed in blue underneath the buttons indicate the Performance parameters.)

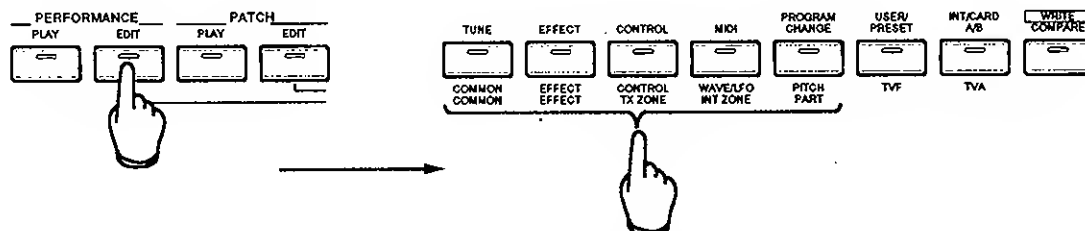

- When **COMMON** or **EFFECT** is pressed, the screen shown below appears in the LCD.

【Example】 When pressing **EFFECT**:

Page name (parameter type)	Related parameters						
PERFORM	#Type	Lev	Rat	Dep	Fbk	Out	1
CHORUS	#CH01	100	60	20	0	MIX	---
	Set values						

When **TX ZONE**, **INT ZONE** or **PART** is pressed, the screen shown below appears in the LCD.

【Example】 When pressing **TX ZONE**:

Page name (parameter type)	Parameter								
TRANSMIT	#C2	102	102	102	102	102	102	102	102
ZONE									
	Part 1	Part 2	Part 3	Part 4	Part 5	Part 6	Part 7	Part 8	
	Set values								

Select different display pages by pressing **▲** or **▼**, when “#” or “#” are indicated in the LCD.

The set values correspond, from left to right, to Parameter Sliders 1 — 8. Use the appropriate Parameter Slider to edit the parameter you wish to change.

■ How to edit a Performance

【Example】

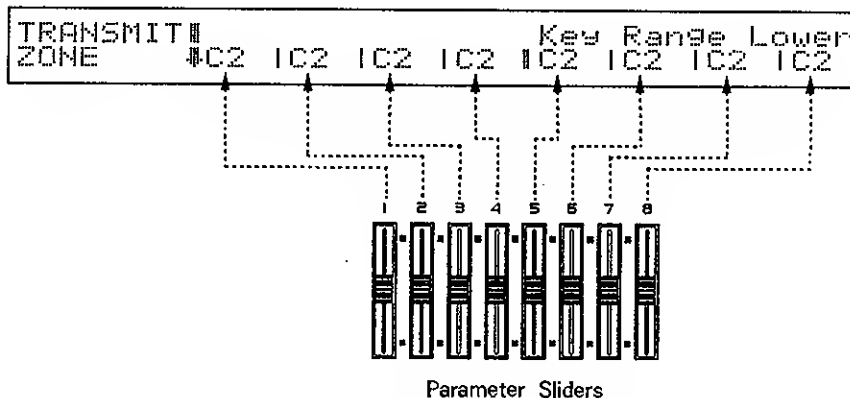

You can also correct or adjust the set value by using the **DEC** and **INC** buttons.

Move the cursor to the value to be changed by pressing **◀/▶**, and press **INC** to increase the value, and press **DEC** to decrease the value.

- ※ Holding **DEC/INC**, **◀/▶** or **▲/▼** down starts the *auto repeat function*, letting you continuously change the value. You can speed up the change in values by holding down one button and then pressing and holding down the other button.

● Using **PART SWITCH**



The **PART SWITCH** buttons (1—8) can be used to function either as on/off switches for enabling the transmission and reception of MIDI data for each Part, or as on/off switches for the sound of each Part. However, the functions that are turned on and off by the **PART SWITCH** buttons (1 — 8) changes according to the Function Select button which is currently pressed.

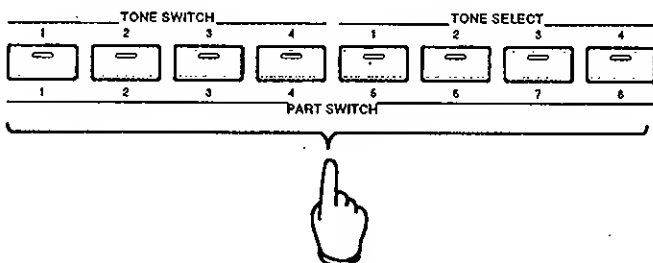

- ※ The function which was turned on/off by **PART SWITCH** buttons (1 — 8) is stored as part of the settings of each Performance by the Write operation (P.154).
- ※ The indicator of the button lights up when it is ON.



The functions which are turned on and off by the **PART SWITCH** buttons (1 — 8) will be explained with the parameter operations below.

● Switching Between Display Pages

Several display pages can be assigned to a function select button. It is possible to switch between two pages each time you press the function select button (the button whose indicator is currently lit): one page is selected by pressing  and the other page is selected by pressing .

By using this function, you can continue editing while comparing parameters on the two pages, or you can immediately select often used pages by pressing  and , saving you time by eliminating the normal page selection steps.



The manner in which pages are switched when the function select button is pressed is shown below.

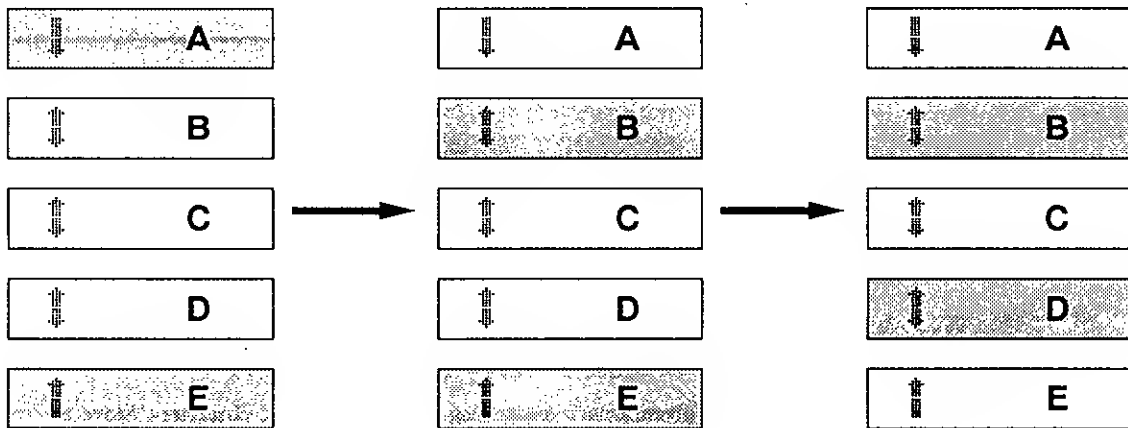

When the power is turned on, you can switch between the first page (A) and the last page (E) each time you press the function select button.

When (A) is selected and you change it to (B) by pressing , you can switch between (B) and (E) each time you press the function select button.

When (E) is selected and you change it to (D) by pressing , you can switch between (B) and (D) each time you press the function select button.



※ When the same page is selected by /, the selected page and the first page are switched each time you press the function select button.

When both  and  are used to select the first page, the first page and the last page are switched.

COMMON

■ Explanations of the parameters

The usage and functions of the parameters are explained in this section in the following order: Common, Transmit Zone, Internal Zone and Part.

Performance Common Parameters

These are used to select the Performance name and key mode effect (chorus and reverb) which are common to all Parts.

Parameters Selected by **COMMON** (2 Pages)

When this button is pressed, the **PART SWITCH** buttons (1 — 8) function as MIDI receive switches for turning MIDI data reception of each Part on and off.

PERFORM NAME (Performance Name) Page

PERFORM NAME [Piano+Bass]

Performance Name Settings: Space, A—Z, a—z, 1—9, 0, + - * / # ! , .

The Tone being edited can be given a name containing a maximum of 12 characters. Move the cursor by using Parameter Slider 2 or the / buttons, then select the characters at the cursor position using Parameter Slider 1 or the **INC** / **DEC** buttons.

Characters can also be selected using the buttons shown below. (The characters and designations are printed in gray directly beneath the buttons.) Press the desired button repeatedly to step through the three-character selection.

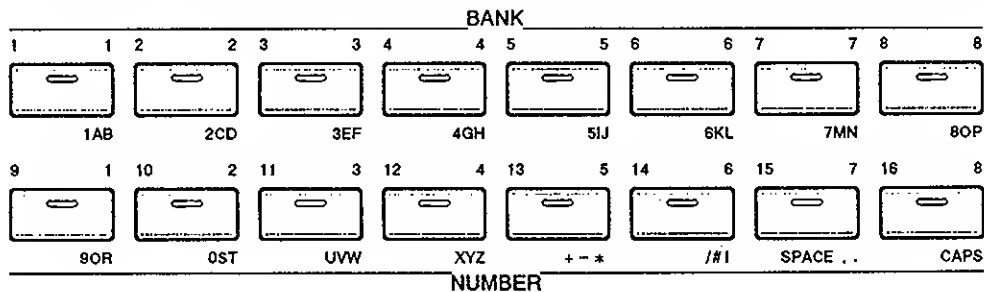

CAPS: Pressing this button switches between capital letters and small letters. When the indicator is lit, it is set to capital letters.

SPACE: This is for entering a space between characters.

KEY MODE Page

KEY MODE	Mode			
	LAYER			

Mode Key Mode Settings: LAYER/ZONE/SINGLE

This determines how the keyboard uses the performance data.

	Use of the performance data	Data transmitted by MIDI
LAYER	The settings of the key range of the internal/transmit zone become invalid; all keyboard performance data is sent to the eight Parts and via MIDI OUT.	<ul style="list-style-type: none"> ● Program change messages are not transmitted even when the Patch is changed.
ZONE	The performance data within the key range set in the internal/transmit zone is sent to the eight Parts and via MIDI OUT.	<ul style="list-style-type: none"> ● When the Performance is changed, program change data, as well as volume data and pan data, which are set in the transmit zone, are transmitted.
SINGLE	The settings of the internal/transmit zone are ignored, and only the Part at the cursor position can be controlled. Playing the keyboard sounds the Patch of the Part at the cursor position.	<ul style="list-style-type: none"> ● The receiving channel numbers which are assigned to the Parts are also used for the transmission channels. ● When the Patch is changed, bank select and program change messages, which correspond to the Patch number, are transmitted. ● When the Performance is changed, bank select and program change messages, which correspond to the Patch number that is assigned to the Part, are transmitted.

EFFECT

Parameters Selected by EFFECT (2 Pages)

These pages are used to set the chorus and reverb effects. Applying chorus and reverb to the sound gives it greater spaciousness and adds depth to the stereo image.

Since these settings are applied equally for all Parts, the effect settings of the Patch itself are ignored.

PERFORM CHORUS (Performance Chorus) Page

From the display that appears in this page, the **PART SWITCH** buttons (1 — 8) function as on/off switches for the chorus effect of each Part.

```
PERFORM  Type|Lev|Rat|Dep|Fbk|Out|  |
CHORUS  #CHO1|100| 60| 20|  0|MIX|---|---
```

Type *Chorus Type* Settings: CHO 1 — 3

This determines the type of chorus effect.

CHO1	Normal chorus
CHO2	Chorus with a slow rate. This also makes a good flanger effect when feedback is applied.
CHO3	Chorus with pronounced depth. This applies substantial detuning to the sound.

Lev *Chorus Level* Range: 0 — 127

This determines the level or volume of the chorus sound. The greater the value, the greater the level.

Rat *Chorus Rate* Range: 0 — 127

This determines the speed of the modulation of the chorus sound. The greater the value, the faster the modulation.

Dep *Chorus Depth* Range: 0 — 127

This determines the depth of the modulation of the chorus sound. The greater the value, the greater the depth of the modulation.

Fbk *Chorus Feedback* Range: 0 — 127

This determines the level of the re-routed (feedback) chorus sound. A richer, more complex chorus effect can be gained by increasing the value of this parameter.

Out *Output Switch* Settings: MIX/REV

This determines the destination of the chorus sound output. When set to MIX, the chorus sound and the reverb sound are mixed with the dry sound; when set to REV, the chorus sound is mixed with the dry signal after reverb is applied.

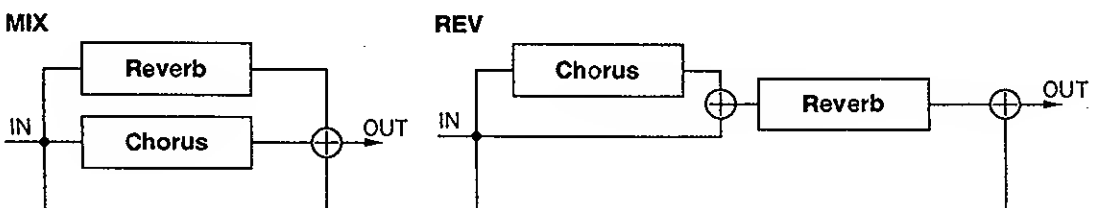

PERFORM REVERB (Performance Reverb) Page

From the display that appears in this page, the **PART SWITCH** buttons (1 — 8) function as on/off switches for the reverb effect of each Part.

```

PERFORM ↑   Type |  Level |  Time | F-Back
REVERB ↓   ROOM1 |    100 |    60 |    20
  
```

Type *Reverb Type* Settings: ROOM 1 — 2/STAGE 1 — 2/HALL 1 — 2/DELAY/PAN-DLY

This determines the type of reverb.

ROOM1	Reverb with short and dense reverberant wash
ROOM2	Reverb with short and sparse reverberant wash
STAGE1	Reverb with strong reverberant wash in the final portion of the sound
STAGE2	Reverb with strong initial reflections
HALL1	Reverb with clear echo
HALL2	Reverb with rich echo
DELAY	Conventional delay
PAN — DLY	Delay in which the reflected sound pans left and right

Level *Reverb Level* Range: 0 — 127

This determines the level or volume of the reverb sound. The greater the value, the greater the level.

Time *Reverb Time* Range: 0 — 127

When ROOM 1 — HALL 2 is selected as the reverb type, this determines the time of the reverberation (reflected sound); when DELAY/PAN-DLY is selected, this determines the delay time.

F-Back *Delay Feedback* Range: 0 — 127

When the type is set to DELAY, this determines the re-routed level (feedback) of the delay sound in the delay. Increasing this setting creates an echo effect of distinct multiple repeats of the sound.

Transmit Zone Parameters

These parameters allow you to determine how the performance data from the JV-80 keyboard is processed in the transmit zone of each Part, before it is transmitted over MIDI.

- ★ Since the performance data from the JV-80 keyboard can be split according to the *key range* and transmitted over MIDI, different external sound sources can be played separately depending on the range.
- ★ Another operation of these parameters, the *transmit transpose* function, lets you change the note number that is transmitted via MIDI, by a certain amount relative to the note played on the JV-80. For example, you can set this value to one octave lower (or higher) to allow playing the connected sound source in a range that would normally be outside of the keyboard. You can also layer octaves of the same sound program, or set up a chord to be played when you press a single key.
- ★ *Transmit velocity max level curve/sensitivity/level*

These parameters allow you to change how loudly or softly the MIDI-connected external sound sources play in response to changes in your playing technique. This is possible through processing of the velocity data from the keyboard for each transmit zone before it is transmitted via MIDI. In order to keep this change in volume or dynamics within a certain range, use the maximum level parameter. This compresses the velocity data from the keyboard that is transmitted over MIDI, making it less than the actual velocity played. The maximum limit of the velocity after being processed is set by the maximum level. By setting the sensitivity to a value between 0 and 32, the minimum limit can also be set.

You can program the JV-80 to switch between two external sound sources (depending on how strongly you play the keyboard) by setting the sensitivity parameters to +32 and -32 for the two transmit zones. (Fig. 1)

For example, when you wish to compensate for an uneven playing technique, such as playing more strongly with your right hand than your left, you can split the two transmit zones by key range. Then select the appropriate velocity curve so that the velocity reaches a high value quickly for the left hand, even though the keys are played softly; also set the sensitivity to around 0 to 20. For the right hand, select the velocity curve so that velocity doesn't increase even when the keys are played strongly, and set the sensitivity to less than 32. Compress the velocity to the desired degree using the maximum level parameter. (Fig. 2)

(Fig. 1)

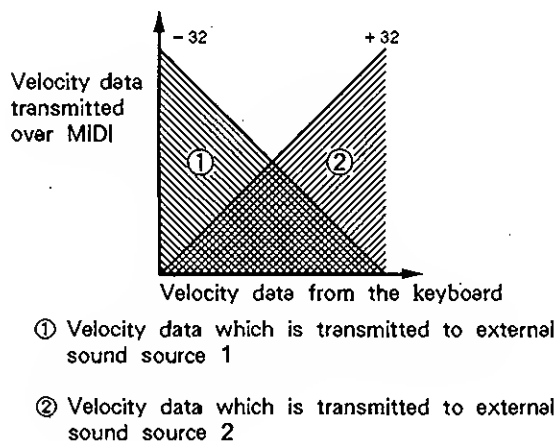

(Fig. 2)

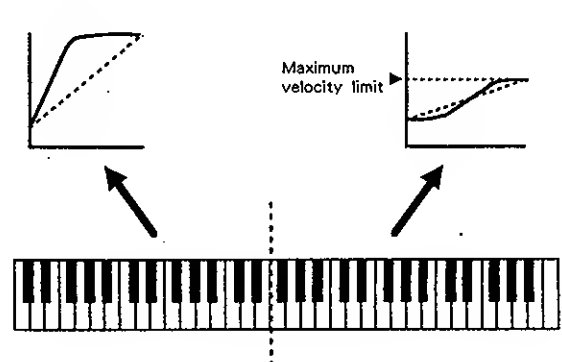

- ★ Since *program change number*, *volume* and *pan* data are transmitted over MIDI when the Performance is called up, you can effectively use the connected external sound sources to provide extra Parts of a Performance from the JV-80.

- ★ Within the transmit zones, you can use the *transmit switch* to turn off the unnecessary zones. By doing so, the performance data of the JV-80 is not transmitted over MIDI.

TX ZONE

Parameters Selected by TX ZONE (11 Pages)

When this button is pressed, the **PART SWITCH** buttons (1 — 8) function as the MIDI transmit switches for turning MIDI data transmission of each Part on and off.

Key Range Lower *Key Range Lower* Range: C-1 — G9

Key Range Upper *Key Range Upper* Range: C-1 — G9

From these two pages, you can specify the lower limit and the upper limit of the transmit zone key range for each Part. As you play the keyboard of the JV-80, only the performance data falling within the key range will be transmitted over MIDI.

```

TRANSMIT | Key Range Lower
ZONE      | C2 | C2 | C2 | C3 | C5 | E3 | F4 | C2
TRANSMIT | Key Range Upper
ZONE      | C7 | C7 | C7 | B5 | C7 | E4 | E5 | C7
    
```

- ✘ Key Range Lower cannot be set to a higher key than Key Range Upper.
- ✘ Since the key range indicates the position on the keyboard, it is not affected by the transpose settings or the pitch that sounds. Therefore, the keyboard is monitored as to whether the keys pressed fall within the specified range or not, regardless of the actual pitch they produce.

Transpose *Transpose* Range: - 36 — +36

This determines the amount by which the MIDI note number data is transposed, relative to the performance data, for the transmit zone of the Part.

```

TRANSMIT | Transpose
ZONE      | 0 | 0 | +12 | -12 | +4 | +7 | 0 | 0
    
```

【Example】

When Transpose is set to +2.

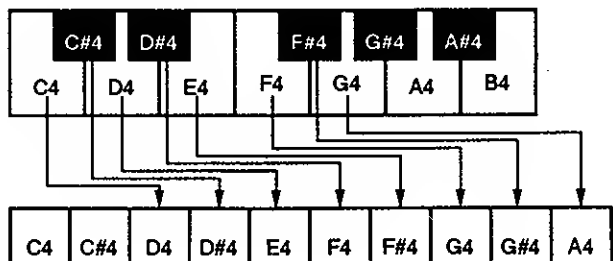

Max Velocity Maximum Velocity Range: 0 — 127

Velocity Sense Velocity Sensitivity Range: - 63 — +63

Velocity Curve Velocity Curve Settings: 1 — 7

These three pages let you set how the transmit zone of each Part processes the velocity from the keyboard.

```

TRANSMIT↑ Max Velocity
ZONE ↓ 127|127|100|100| 80|115|115|127
  
```

```

TRANSMIT↑ Velocity Sense
ZONE ↓ +32|+32|+10| 0|-10|-32|+25|+32
  
```

```

TRANSMIT↑ Velocity Curve P1=2 ✓
ZONE ↓ 2| 3| 1| 4| 2| 1| 6| 2
  
```

The velocity is compressed to values less than the maximum velocity.

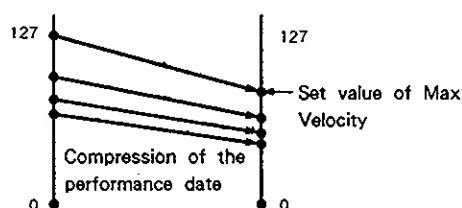

The velocity sensitivity changes the strength (or weakness) of the velocity that is applied to the sound. When the velocity sensitivity is positive (+), the harder the keys are hit, the greater the velocity. Conversely, when the value is negative (-), the harder the keys are hit, the lower the velocity. The farther the value is set from 0, the more pronounced the effect is for both positive and negative values.

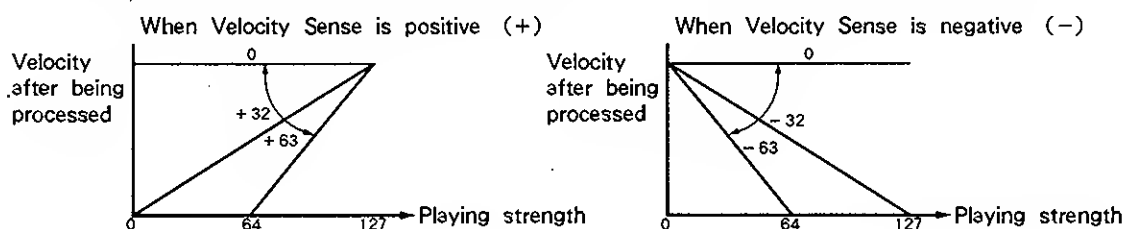

In this case, velocity sensitivity is adjusted by the velocity curves.

The mark which indicates the shape of the selected curve is shown at the top right of the display.

Velocity curves

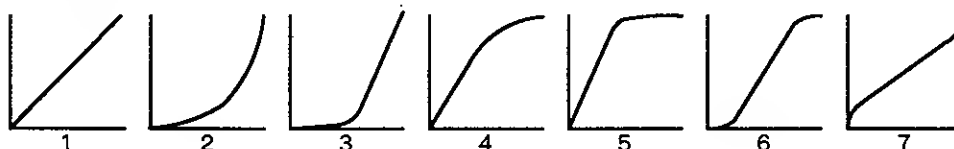

TX ZONE

[Example]

The following settings will result in a velocity response curve like that shown in the graph to the right.

Max Velocity 100
 Velocity Curve 6
 Velocity Sensitivity +32

Transmit Channel *Transmit Channel* Range: 1 — 16

This determines the MIDI transmission channel for the transmit zone of each Part. When the key mode is set to SINGLE (P.xx), the transmit channel becomes the same as the reception channel for the Part and any setting made here has no effect.

```

TRANSMIT# Transmit Channel
ZONE     #  11  21  31  41  51  61  71  10
    
```

Transmit Program Change *Transmit Program Change*

Settings: A11 — A88/B11 — B88/OFF

This determines the program change data transmitted over MIDI for the transmit zone of each Part. The program change number of the selected Part is indicated at the top right of the display. Program change messages are not transmitted over MIDI when this is set to OFF.

```

TRANSMIT# Transmit Program Change P1=001
ZONE     #A11A12A13A14A15A16A17A18
    
```

※ The program change number is transmitted when the Performance is changed up.

Transmit Volume *Transmit Volume* Range: 0 — 127/OFF

This determines the volume data transmitted over MIDI for the transmit zone of each Part. The maximum volume data is 127. Volume data is not transmitted over MIDI when this is set to OFF.

```

TRANSMIT# Transmit Volume
ZONE     #1271127110011001 851 8511271127
    
```

※ The transmit volume is transmitted when the Performance is changed up.

Transmit Pan *Transmit Pan* Settings: L64 — 0 — 63R/OFF

This determines the pan data transmitted over MIDI for the transmit zone of each Part. The sound position is at the farthest left at L64, at the center at 0, and at the farthest right at 63R. Pan data is not transmitted over MIDI when this is set to OFF.

```

TRANSMIT#      Transmit Pan
ZONE           # 0 1 0 1L64|L32| 0 |32R|L64| 0
  
```

※The transmit pan is transmitted when the Performance is changed up.

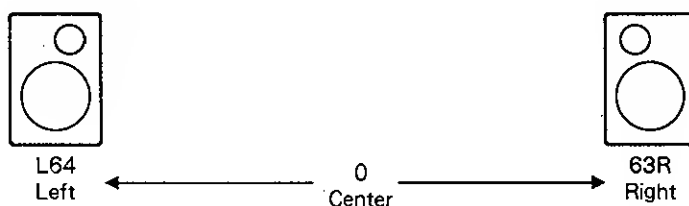
**Transmit Switch** *Transmit Switch* Settings: ON/OFF

This determines whether MIDI transmission from the transmit zone of each Part is enabled (ON) or disabled (OFF). When this is set to OFF and a Performance is selected, program change, volume or pan data is not transmitted over MIDI.

```

TRANSMIT#      Transmit Switch
ZONE           # ON| ON| ON|OFF|OFF| ON| ON|OFF
  
```

※ The settings of this page are automatically changed, when switching the transmit switch on and off with the **PART SWITCH** buttons.

※ The settings here become invalid when the key mode is set to SINGLE.

Internal Zone Parameters

These parameters allow you to determine how the performance data from the JV-80 keyboard is processed in the internal zone of each Part. The contents of the parameters are the same as that of the transmit zone.

- ★ Since the performance data from the JV-80 keyboard can be split according to the *key range*, different Patches can be played separately depending on the range.

- ★ The *transpose* function lets you change the note number played by the internal sound source, relative to the note actually played on the keyboard. For example, you can set this value to one octave lower or higher to allow playing notes in a range that would normally be outside of the keyboard. You can also layer octaves of the same sound program, or set up a chord to be played when you press a single key.

- ★ *Internal Velocity Max Level Curve/Sensitivity/Level*
By passing the velocity data from the keyboard processing to each internal zone, it is possible to change the velocity for each Part. In order to keep the change of velocity within a specific range, set the max level. Then the velocity data from the keyboard is passed to Parts being compressed to less than the maximum level. The maximum limit of the velocity after being processed is set by the max level. By setting the sensitivity between 0 and 32, the minimum limit can be set.
You can program the JV-80 to switch between two sounds (depending on how strongly you play the keyboard) by setting the sensitivity parameters to +32 and - 32 for the two internal zones.
For example, when assigning the attack portion and the sustain portion of a sound to two separate Parts, set the sensitivity of the Part assigned to the attack portion to a value larger than 32 so that it will start sounding when you play beyond a certain strength. Also set the sensitivity of the Part assigned to the sustain portion to a value smaller than 32 so that it will sound even when the keys are played softly.

- ★ Within the internal zones, you can use the *local switch* to turn off the unnecessary zones, so that the performance data of the JV-80 is not sent to its internal sound source.

Parameters Selected by INT ZONE (7 Pages).....

When this button is pressed, the **PART SWITCH** buttons (1 — 8) function as local on/off switches for turning reception of play data from the keyboard on and off for each Part.

Key Range Lower *Key Range Lower* Range: C-1 — G9

Key Range Upper *Key Range Upper* Range: C-1 — G9

From these two pages, you can specify the lower limit and the upper limit of the internal zone key range for each Part. As you play the keyboard, the Part will respond to only the performance data falling within the key range.

```
INTERNAL  Key Range Lower
ZONE     C2 IC2 IC2 IC3 IC5 IE3 IF4 IC2
```

```
INTERNAL  Key Range Upper
ZONE     C7 IC7 IC7 IB5 IC7 IE4 IE5 IE7
```

- ※ Key Range Lower cannot be set to a higher key than Key Range Upper.
- ※ Since the key range indicates the position on the keyboard, it is not affected by the transpose settings or the pitch that sounds. Therefore, the keyboard is monitored as to whether the keys pressed fall within the specified range or not, regardless of the actual pitch they produce.

Transpose *Transpose* Range: - 36 — +36

This determines the amount that the internal zone of each Part transposes the note number data, relative to the notes actually played on the keyboard, for sounding the Patch.

```
INTERNAL  Transpose
ZONE     01 01+12|-12| +4| +7| 01 0
```

INT ZONE

Max Velocity *Maximum Velocity* Range: 0 — 127

Velocity Sense *Velocity Sensitivity* Range: - 63 — +63

Velocity Curve *Velocity Curve* Settings: 1 — 7

These three pages let you set how the internal zone of each Part processes the velocity from the keyboard.

```
INTERNAL ↑ Max Velocity
ZONE ↓ 127 | 127 | 127 | 127 | 127 | 127 | 127 | 127
```

```
INTERNAL ↑ Velocity Sense
ZONE ↓ +32 | +32 | +32 | +32 | +32 | +32 | +32 | +32
```

```
INTERNAL ↑ Velocity Curve P1=3_/_
ZONE ↓ 3 | 3 | 3 | 3 | 3 | 3 | 3 | 3
```

The velocity is compressed to values less than the maximum velocity.

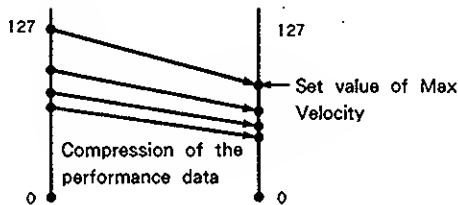

The velocity sensitivity changes the velocity that is applied. When the velocity sensitivity is positive (+), the harder the keys are hit, the greater the velocity. Conversely, when the value is negative (-), the harder the keys are hit, the lower the velocity. The farther the value is set from 0, the more pronounced the effect is for both positive and negative values.

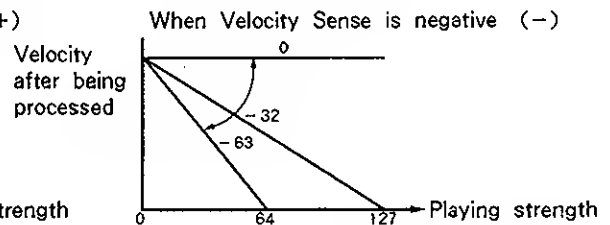
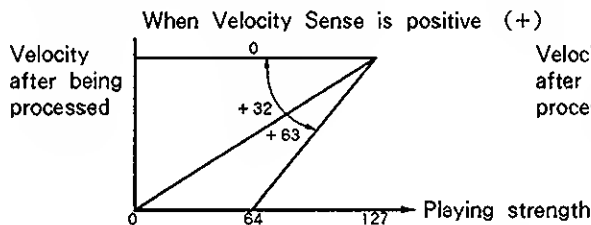

In this case, the velocity is adjusted with the velocity curves.

The mark which indicates the shape of the selected curve is shown at the top right of the display.

Velocity curves

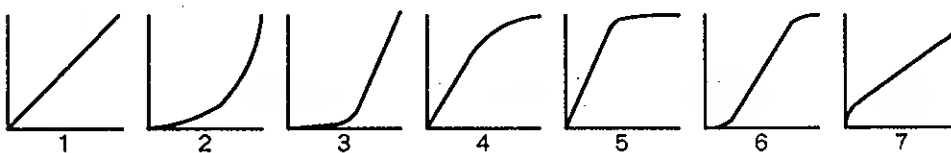

【Example】

The following settings will result in a velocity response curve like that shown in the graph to the right.

Max Velocity 110
 Velocity Curve 4
 Velocity Sensitivity -32

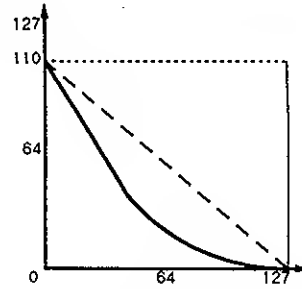

Local switch Local Switch Settings: ON/OFF

This determines whether the internal zone of each Part passes the performance data to the Patch or not. When this is set to OFF, the Patch does not respond to performance data.

```
INTERNAL# Local Switch
ZONE  # ONI ONI ONI ONI ONI ONI ONI ONI
```

※ The settings of this page are automatically changed, when switching the local switch on and off with the **PART SWITCH** buttons.

Part Parameters

These determine the conditions of each Part when a Performance is called up, and also determine how the eight Patches are to be combined.

- ★ You can assign the Patches to Parts 1 — 8. Any of the Patches can be called up; however, *when a DATA card has not been properly inserted into the DATA card slot, Patches stored to a DATA card cannot be selected.*
- ★ *Level (volume), pan (stereo position), and tuning* settings can be made for the sound program of each Part. Using these parameters lets you adjust the balance and overall sound of an entire Performance. These are useful in creating a single multi-component sound program with a whole Performance, or when building an ensemble sound with several Parts.
- ★ The *chorus switch and reverb switch* in this section allow you to determine whether or not the signals are sent to the chorus and reverb. By turning the effects of each Part on and off, you can choose the proper ambience and dynamics for the sound. For example, turn the switches off for Parts which require a tightly defined stereo position or a clear sonic outline. When you want to combine all sound programs in making a single sound, it is effective to turn on the switches for all the Parts.

When set to ON, the signals are sent with the send level set in the Patch parameters. When set to OFF, the effect is not applied.

This parameter can be changed in realtime while playing from the Performance Play mode.

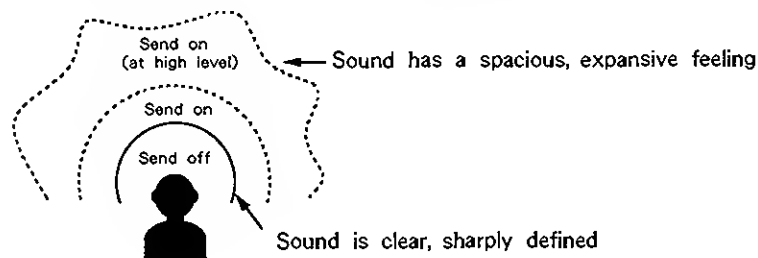

- ★ *The JV-80 has a total of twenty-eight voices.* Since several voices may be used when sounding a single Tone, many voices are required when playing just one Patch. If you try to play more voices than the twenty-eight-voice limit, previously played Tones will be cancelled to accommodate newly played ones. You can, however, reserve a minimum necessary number of voices for specific Parts; this comes in handy when you have an important Part that you wish to continue sounding, or avoid a certain Part from being too abruptly or too obviously cut off. This is called the *voice reserve* function.

For example, when you need a certain Patch, which is made up of three Tones, to sound at least two notes, the number of the voices you should reserve is six (two times three).

The total number of voices reserved for each Part cannot exceed twenty-eight.

- ★ This section includes MIDI receiving settings for the Parts. This lets you use the JV-80 as a MIDI sound source with a maximum of eight Parts, if the receiving channels are set properly. The Parts to be played by the keyboard do not respond to MIDI data when the MIDI receive switch is turned off.

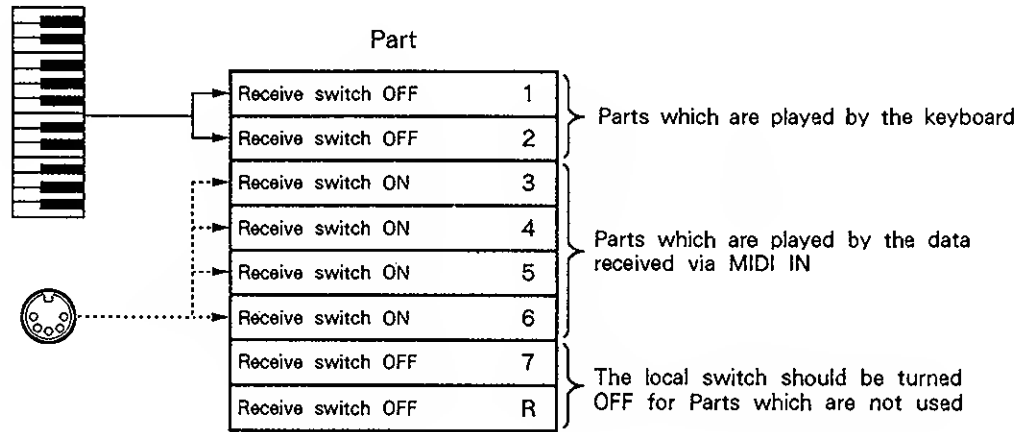

PART

Parameters Selected by PART (13 Pages)

When this button is pressed, the **PART SWITCH** buttons (1 — 8) function as MIDI receive switches for turning MIDI data reception of each Part on and off.

Patch Select *Patch Select*

Settings : A-11 — 88/B-11 — 88/I-11 — 88/ C-11 — 88/Rhythm Set (PRA/PRB/INT/CARD)

This determines the Patch to be assigned to each Part (Part 8 is used for the Rhythm Set). Selection can be made from a total of 256 programs: 64 from internal (I), 64 from DATA card (C), and 64 each from presets A and B. The Rhythm Set can be selected from preset A (PRA), preset B (PRB), internal (INT), and DATA card (CRD). When the Patch has been selected, the Patch name is shown at the top right of the display.

```
PART      █ Patch Select P1=A.Piano 1
PARAM    ↓ I11 I12 I13 I14 I15 I16 I17 IINT
```

Level *Part Level* Range: 0 — 127

This determines the level (volume) of each Part. We suggest that you set this to the maximum level (127) when there is no need to set a relative level balance among the Parts.

```
PART      ↑ Level
PARAM    ↓ 127 I127 I127 I127 I127 I127 I127 I127
```

Pan *Part Pan* Settings: L64 — 0 — 63R

This determines the stereo position of each Part. The sound position is at the farthest left at L64, at the center at 0, and at the farthest right at 63R. Keep in mind that the actual pan setting also depends on, and is multiplied with, the pan setting made for the Patch.

```
PART      ↑ Pan
PARAM    ↓ 0 I 0 IL64 IL32I 0 I32R I63R I 0
```

Coarse Tune *Coarse Tune* Range: - 48 — +48

Fine Tune *Fine Tune* Range: - 50 — +50

The pitch at which a Part will sound is determined by the parameter settings on these two pages. The coarse tune parameter changes the pitch in semitone increments, while fine tune changes the pitch in units of 1/100 of a semitone. When the value is positive (+), the pitch is higher than normal, and when negative (-), the pitch is lower.

PART	↑					Coarse Tune		
PARAM	↓	01	01	01	+121	-121	+41	+81

PART	↑					Fine Tune		
PARAM	↓	-51	-101	+101	+51	01	01	01

- ※ The transpose setting for the Part shifts the pitch relative to the setting made for the Patch. In other words, the actual pitch that sounds depends on the Patch setting.

Receive Channel *Receive Channel* Range: 1 — 16

This determines the MIDI receiving channel of each Part.

PART	↑					Receive Channel		
PARAM	↓	11	21	31	41	51	61	71

- ※ *Keep in mind that when this is set to the same channel as the control change (P.76) of the system common parameter, the setting of the control channel has priority, and the Performance will be changed when receiving a program change message.*

Voice Reserve *Voice Reserve* Range: 0 — 28

This determines the number of voices that are reserved for each Part. Since a Part consists of a Patch, which in turn is made up of Tones, multiply the number of Tones used by the number of voices you want each Tone to sound; this gives you the number of voices you should set in this parameter. Since the total number of voices on the JV-80 is 28, the total of the voice reserve settings for each Part cannot exceed 28.

PART	↑					Voice Reserve		
PARAM	↓	41	41	41	41	41	41	01

Chorus Switch *Chorus Switch* Settings: ON/OFF

This determines whether the signals are sent to the chorus (ON) or not (OFF). When this is set to ON, the level of the signal to be sent is determined by the chorus send level, which is set individually for each Tone in the Patch.

PART	↑					Chorus Switch		
PARAM	↓	ON1	ON1	OFF1	OFF1	OFF1	OFF1	ON

PART

Reverb Switch *Reverb Switch* Settings: ON/OFF

This determines whether the signals are sent to the reverb (ON) or not (OFF). When this is set to ON, the level of the signal to be sent is determined by the reverb send level, which is set individually for each Tone in the Patch.

PART	↑										Reverb Switch
PARAM	↓	ON	OFF	OFF	OFF	OFF	OFF	OFF	OFF	OFF	ON

Receive Program Change *Program Change Receive Switch* Settings: ON/OFF

This determines whether each Part receives program change messages (ON) or not (OFF).

PART	↑											Receive Program Change
PARAM	↓	OFF	OFF	ON	ON	ON	ON	ON	ON	OFF	OFF	OFF

Receive Volume *Volume Receive Switch* Settings: ON/OFF

This determines whether each Part receives the volume data (ON) or not (OFF).

PART	↑											Receive Volume
PARAM	↓	OFF	OFF	ON	ON	ON	ON	OFF	OFF	OFF	OFF	OFF

Receive Hold-1 *Hold-1 Receive Switch* Settings: ON/OFF

This determines whether each Part receives the Hold 1 data (ON) or not (OFF).

PART	↑											Receive Hold-1
PARAM	↓	OFF	OFF	ON	ON	ON	ON	ON	OFF	OFF	OFF	OFF

Receive Switch *MIDI Receive Switch* Settings: ON/OFF

This determines whether each Part receives MIDI data (ON) or not (OFF).

PART	↑											Receive Switch
PARAM	↓	OFF	OFF	ON	ON	ON	ON	ON	OFF	OFF	OFF	OFF

※ The settings of this page are automatically changed, when switching the MIDI receive switch on and off with the **PART SWITCH** buttons.

3. Rhythm Edit Mode

Editing procedures for the Rhythm Tone and the various functions of the parameters are explained in this section.

■ What are rhythm sound programs?

The JV-80 features a special Rhythm Set (a group of rhythm sounds) in the internal memory and presets A and B. When **PART SWITCH** 8 is turned on in Performance play, the Rhythm Set which is assigned to Part 8 can be played. For Parts 1 — 7, playing keys on the keyboard triggers the sounds of a Patch at pitches that correspond to the key position (key number). For Part 8, however, the assigned rhythm sound program (Rhythm Tone) produces the sounds. The assignable range is over 61 keys, from C2 to C7.

Just as with the other Parts, parameters such as key range, effects and MIDI transmitting/receiving channels can be set for the Rhythm Tone.

※ See P.xx for a list of the Rhythm Tones and their key assignments.

■ Rhythm Tone Editing

※ Rhythm Tones are edited just like standard Tones.

※ The edited Rhythm Tones are assigned individually to the keys of the keyboard, and stored as a Rhythm Set. One edited Rhythm Set can be stored internal memory (INT) and another can be stored on a DATA card (CARD).

① Select the Rhythm Edit mode by pressing **RHYTHM** (the indicator lights), and press one of the **EFFECT**, **CONTROL**, **WAVE/FLO**, **PITCH**, **TVF** or **TVA** buttons in order to call up the desired parameter. (These buttons are the same as those used when calling up Patch parameters.)

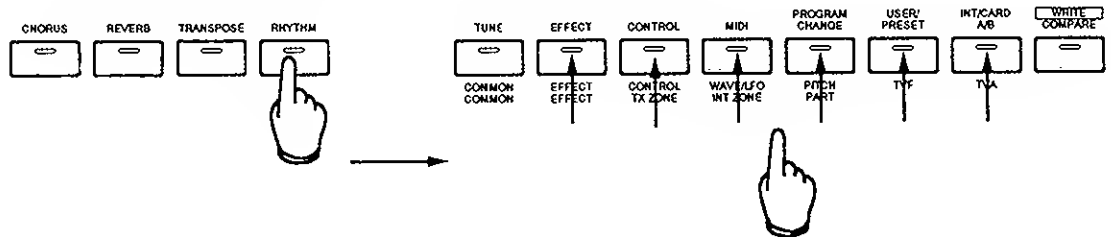

② When the Rhythm Edit mode is selected, the following display will appear.

[Example]

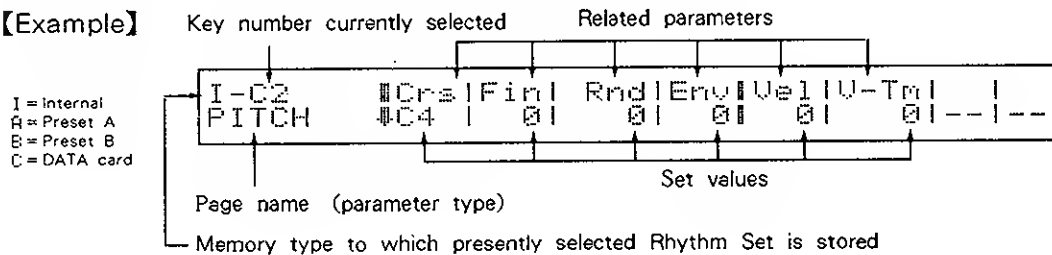

■ Rhythm Tone Editing

The set values correspond, from left to right, to Parameter Sliders 1 — 8. Use the appropriate Parameter Slider to edit the parameter you wish to change.

【Example】

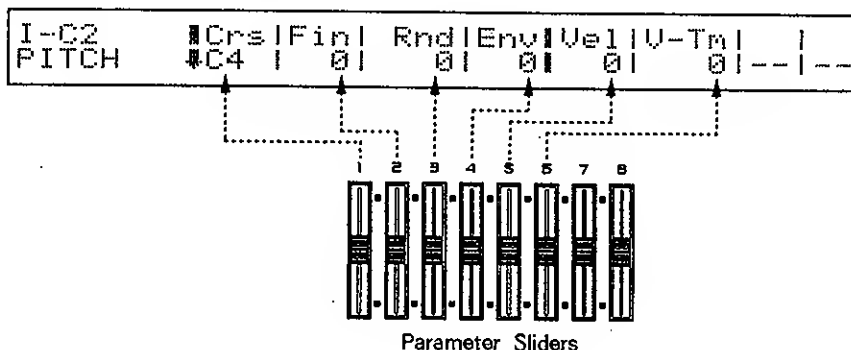

Pages are changed by pressing **▲**/**▼** when “**♯**” or “**♭**” are displayed in the LCD. The pages are also switched each time the currently selected function select button is pressed.

You can adjust the set value by using the **DEC** and **INC** buttons. Move the cursor to the value to be changed by pressing **◀**/**▶**, and press **INC** to increase the value, and press **DEC** to decrease the value.

- ※ Holding **DEC**/**INC**, **◀**/**▶** or **▲**/**▼** down starts the auto repeat function, letting you continuously change the value. You can speed up the change in values by holding down one button and then pressing and holding down the other button.
- ③ Displayed in the upper left corner of the LCD are two marks: one indicates the memory type to which the currently selected Rhythm Tone/Rhythm Set belongs, and the other indicates the key number to which the Rhythm Tone is assigned. Specify the Rhythm Tone to be edited by pressing either the key to which the Rhythm Tone is assigned, or one of the **TONE SELECT** buttons 1 — 4. The display of the key number changes according to the selected key.

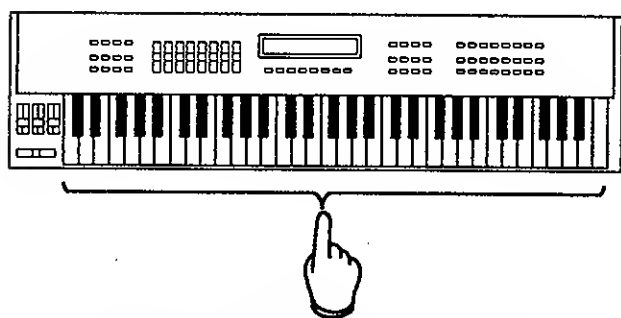

You can edit a Rhythm Tone by pressing the key to which it is assigned.

OR

TONE SELECT 1

Each press of this button shifts the currently displayed key number down one octave.

TONE SELECT 2

Each press of this button shifts the currently displayed key number down one semitone.

TONE SELECT 3

Each press of this button shifts the currently displayed key number up one semitone.

TONE SELECT 4

Each press of this button shifts the currently displayed key number up one octave.

- ※ When editing a Rhythm Set which is stored in another memory type, move to the Performance Play mode, and switch it to the memory type of the desired Rhythm Set, then select the Rhythm Edit mode again.

■ Explanations of the parameters

From this point on, the main parameters of each button (and their uses) are described, followed by explanations on how to edit the parameters.

Parameters Selected by **EFFECT** (3 Pages)

FX SEND (effect send) page

I-C2		Dry	Chorus	Reverb	
FX SEND	#	127	0	80	-----

Dry *Dry Level* Range: 0 — 127

This determines the level of the direct or unprocessed sound (the sound with no effect applied).

Chorus *Chorus Send Level* Range: 0 — 127

This determines the level of the signal sent to the chorus.

Reverb *Reverb Send Level* Range: 0 — 127

This determines the level of the signal sent to the reverb.

The following two pages are used for making settings for the chorus and reverb. These parameters belong to the Performance which are currently called up to the temporary area. Therefore, effect data which is set for the Rhythm Set here, must be stored as Performance data. However, when this Rhythm Set is called up from another Performance, the effect settings of the selected Performance are called up and take precedence.

PERFORM CHORUS (Performance Chorus) Page

PERFORM	Type Lev Rat Dep Fbk Out	
CHORUS	#CHO1 100 60 20 0 MIX	-- ---

Type *Chorus Type* Settings: CHO 1 — 3

This determines the type of chorus.

CHO1	Normal chorus
CHO2	Chorus with a slow rate. This also makes a good flanger effect when feedback is applied.
CHO3	Chorus with pronounced depth. This applies substantial detuning to the sound.

Lev *Chorus Level* Range: 0 — 127

This determines the level or volume of the chorus sound. The greater the value, the greater the level.

EFFECT**Rat** *Chorus Rate* Range: 0 — 127

This determines the speed of the modulation of the chorus sound. The greater the value, the faster the modulation.

Dep *Chorus Depth* Range: 0 — 127

This determines the depth of the modulation of the chorus sound. The greater the value, the deeper the modulation.

Fbk *Chorus Feedback* Range: 0 — 127

This determines the level of the re-routed (feedback) chorus sound. A richer, more complex chorus effect can be gained by boosting this parameter.

Out *Output Switch* Settings: MIX/REV

This determines the destination of the chorus sound output. When set to MIX, the chorus sound and the reverb sound are mixed with the dry sound; when set to REV, the chorus sound is mixed with the dry signal after reverb is applied.

PERFORM REVERB (Performance Reverb) Page

PERFORM	↑	Type	Level	Time	F-Back
REVERB		ROOM1	100	60	20

Type *Reverb Type* Settings: ROOM 1 — 2/STAGE 1 — 2/HALL 1 — 2/DELAY/PAN — DLY

This determines the type of reverb.

ROOM1	Reverb with short and dense reverberant wash
ROOM2	Reverb with short and sparse reverberant wash
STAGE1	Reverb with strong reverberant wash in the final
STAGE2	portion of the sound
HALL1	Reverb with strong initial reflections
HALL2	Reverb with clear echo
DELAY	Reverb with rich echo
PAN — DLY	Conventional delay

Level *Reverb Level* Range: 0 — 127

This determines the level or volume of the reverb sound. The greater the value, the greater the level.

Time *Reverb Time* Range: 0 — 127

When ROOM 1 — HALL 2 is selected as the reverb type, this determines the time of the reverberant sound; when DELAY/PAN-DLY is selected, this determines the delay time.

F-Back *Delay Feedback* Range: 0 — 127

When the type is set to DELAY, this determines the re-routed level (feedback) of the delay sound in the delay. Increasing this setting creates an echo effect of distinct multiple repeats of the sound.

Parameters Selected by **CONTROL** (1 Page)

- ★ A single musical instrument is capable of producing many different sounds, depending on the playing techniques used. To reproduce these different sounds by using several Rhythm Tones simultaneously, the Tones can be assigned to a special group, the Mute Group, that keeps the Tones from all sounding at the same time. For example, set the the open hi-hat and closed hi-hat sounds to the same Mute Group number, so that playing one of the sounds automatically cuts off the sound of the other.
- ★ Set the Envelope mode to NO-SUS for sound programs like castanet and snare drum, the sounds of which decay quickly, to prevent the decay of the sound from being altered by note off data or the use of the sustain pedal. On the other hand, for instruments like timpani and cymbals, the sound is often muted in the middle of the sound. For these types of sounds, set the Envelope mode to SUS, and release the key (key off) when you want to mute the sound.

CONTROL Page

I-C2	Bender Env-Mode Mute-Grp
CONTROL	21 NO-SUS OFF -----

Bender *Bend Range* Range: 0 — 12

This determines the pitch bend range of the bender/modulation lever, when it is moved laterally. The parameter is set in semitone units and changes the pitch by one octave at the maximum value (12).

Env-Mode *Envelope Mode* Settings: NO-SUS/SUS

This determines how the Rhythm Tone will sound. When this is set to NO-SUS, the time from the sustain level (L3) to the key off point is ignored by the TVA envelope of the Rhythm Tone, and the decay starts immediately. The sound stops sounding after a certain time ($T1 + T2 + T3 + T4$). When this is set to SUS, the Rhythm Tone can be muted by releasing the key played, since the sustain level is maintained until the key off point.

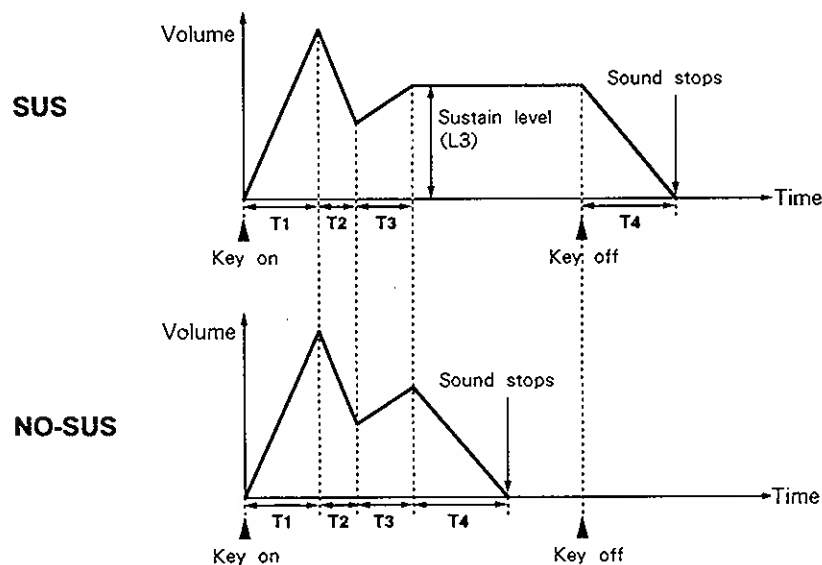

CONTROL / **WAVE/LFO**

Mute-Grp *Mute Group* Settings: OFF/1 — 31

By numbering the Rhythm Tones, similarly numbered Tones are treated as a Mute Group. A Mute Group functions such that when one Rhythm Tone of the same group sounds, the other Rhythm Tones will not sound (are muted).

Up to 31 groups are available. When this is set to OFF, the mute function is disabled.

Parameters Selected by **WAVE/LFO** (1 Page).....

WAVE Page

I-C2	█	Switch	Group	No	1
WAVE	█	ON	INT	87	(LA Snare)

Switch *Tone Switch* Settings: ON/OFF

This determines whether the currently selected Rhythm Tone sounds (ON) or not (OFF).

Group *Wave Group* Settings: INT/EXP/CARD

This determines the type of waveform that is to be used in creating individual Rhythm Tones, just as with normal Tones. Waveforms can be selected from the internal memory (INT), expansion board (EXP) and PCM cards (CARD).

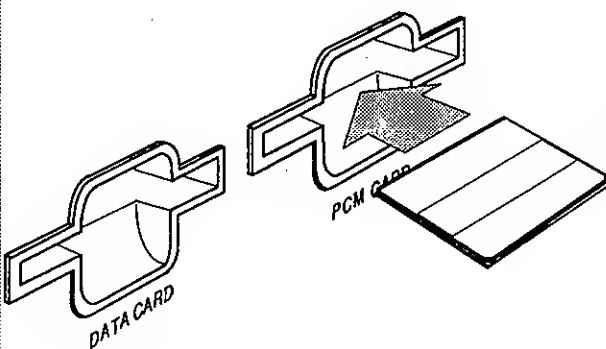

● Inserting the PCM Card

With the label side facing upward, gently (but firmly) insert the PCM card into the PCM CARD slot on the rear panel.

※ The design of the CARD shown in the drawing differs from an actual one.

No *Wave Number*

This selects a single waveform from the specified wave group. The wave name of the set wave number is displayed in parentheses () in the display.

Parameters Selected by **PITCH** (2 Pages)

PITCH page:

I-C2	#Crs	Fin	Rnd	Env	Vel	V-Tm		
PITCH	#C4		0	0	+1	+5	+10	-- --

Crs *Pitch Coarse* Range: C-1 — G9

This determines which key of the waveform should sound.

※ The sounding range of some waveforms has an upper limit, beyond which pitches will not sound. When the pitch coarse setting is higher than this limit, the pitch that sounds will be the upper limit pitch.

Fin *Pitch Shift Fine* Range: - 50 — +50

This offsets the pitch of the Tone in units of 1/100 of a semitone. The pitch is shifted higher than normal when the value is positive (+), and is shifted lower when the value is negative (-).

Rnd *Random Pitch Depth* Settings: 0/5/10/20/30/40/50/70/100/200/300/400/500/600/800/1200

The pitch of the Rhythm Tone is shifted over random amounts within the range set here. The value is expressed in units of 1/100 of a half-step.

Env *Pitch Envelope Depth* Range: - 12 — +12

This determines the maximum change rate of the pitch according to the level of the envelope. When the depth is positive (+), the greater the level of the pitch envelope, the higher the pitch. When the depth is negative (-), the greater the level of the envelope, the lower the pitch.

Vel *Velocity Envelope Level Sensitivity* Range: - 63 — +63

This determines how the level of the pitch envelope changes according to velocity. When the value is positive (+), the greater the velocity, the greater the level. When the value is negative (-), the lesser the velocity, the greater the level.

V-Tm *Velocity Envelope Time Sensitivity*

Settings: - 100/ - 70/ - 50/ - 40/ - 30/ - 20/ - 10/0/+10/+20/+30/+40/+50/+70/+100

This parameter allows you to set the degree to which the time of the entire pitch envelope responds to playing strength (velocity). When the value is positive (+), the greater the velocity, the longer the time. When the value is negative (-), the greater the velocity, the shorter the time. No change results at 0.

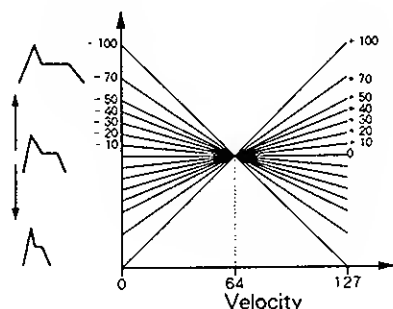

PITCH

P-ENV (Pitch Envelope) Page

I-C2	↑	T1	T2	T3	T4	L1	L2	L3	L4
P-ENV	↑	5	10	30	80	+63	-10	0	+10

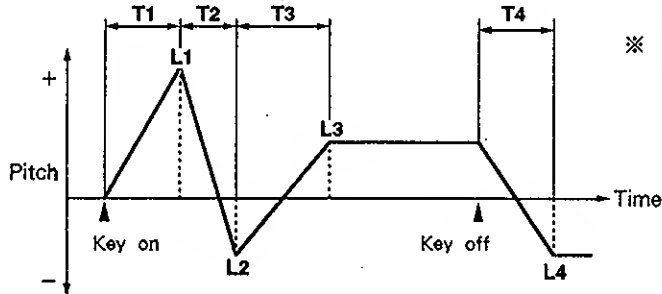

※ When the envelope depth is negative (-), the direction of the pitch change is reversed.

T1 **T2** **T3** **T4** Range: 0—127

These determine the time settings (T1, T2, T3 and T4) of the pitch envelope. Each setting represents the time it takes for the pitch to change from one point to the next; for example, T2 is the time it takes the pitch to change from L1 to L2. The greater the value, the longer the time it takes to reach the next level.

L1 **L2** **L3** **L4** Range: -63—+63

These parameters determine the level settings (L1, L2, L3 and L4) of the pitch envelope. They determine the amount by which the pitch is changed at each point. The standard pitch here is the same as the value set in the pitch shift coarse/fine parameters. When the value is positive (+), the pitch is higher than standard pitch. When the value is negative (-), the pitch is lower than standard pitch. When set to 0, pitch remains unchanged (at standard pitch).

Parameters Selected by TVF (2 Pages)

The functions of the TVF are set in these pages.

TVF page

```
I-C2      #TYP|Cut|Res|Mode|Env|Ue1|U-Tm|
TVF       #LPF|100| 50|SOFT|+48|+32| +70|-
```

Typ Filter Type Settings: LPF/HPF/OFF

This determines the type of TVF. LPF sets it to low pass filter operation, and HPF sets it to high pass filter. Filter operation is cancelled when set to OFF.

Cut Cutoff Frequency Range: 0 — 127

This determines the cutoff frequency, above or below which TVF is applied for filtering out the specified frequency elements of the waveform. The greater the value, the higher the cutoff frequency.

Res Resonance Range: 0 — 127

This emphasizes the frequency elements of the waveform around the cutoff frequency. The greater the value, the stronger the resonance effect.

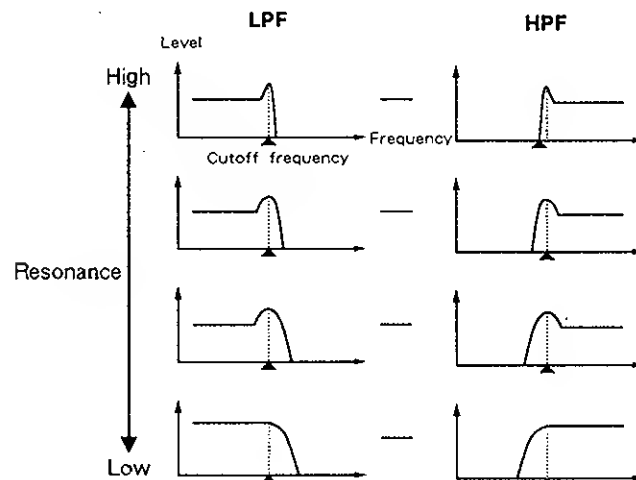
**Mode** Resonance Mode Settings: SOFT/HARD

This determines the type of resonance. When this is set to SOFT, the resonance effect is moderate; when set to HARD, the resonance effect is more pronounced.

- ※ There are some cases in which the resonance effect decreases, such as when the Tone level is high when it sounds, or when the cutoff frequency is high.

TVF

Env TVF Envelope Depth Range: - 63 — +63

This determines the maximum range over which the envelope changes the cutoff frequency. When the value is positive (+), the greater the depth of the envelope, the higher the cutoff frequency. When the value is negative (-), the greater the depth of the envelope, the lower the cutoff frequency.

Envelope depth

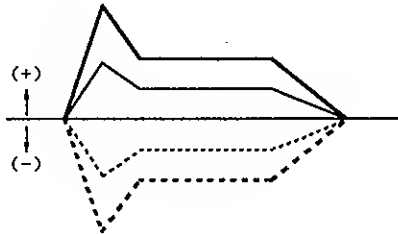

Vel Velocity Envelope Level Sensitivity Range: - 63 — +63

This determines how the level of the TVF envelope changes according to velocity. When the value is positive (+), the greater the velocity, the greater the level. When the value is negative (-), the lower the velocity, the greater the level.

V-Tm Velocity Time Sensitivity

Settings: - 100/ - 70/ - 50/ - 40/ - 30/ - 20/ - 10/0/+10/+20/+30/+40/+50/+70/+100

This parameter allows you to set the degree to which the time of the entire TVF envelope responds to playing strength (velocity). When the value is positive (+), the greater the velocity, the longer the time. When the value is negative (-), the greater the velocity, the shorter the time. No change results at 0.

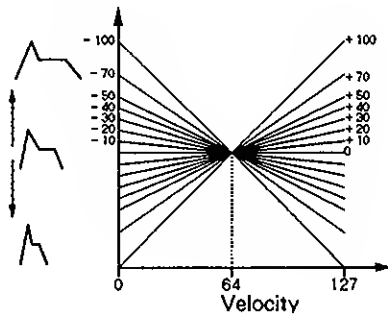

TVF-ENV (TVF Envelope) Page

This page lets you set how the cutoff frequency changes over time (TVF envelope).

I-C2	↑	T1	T2	T3	T4	L1	L2	L3	L4
TVF-ENV	■	10	10	50	70	127	100	85	0

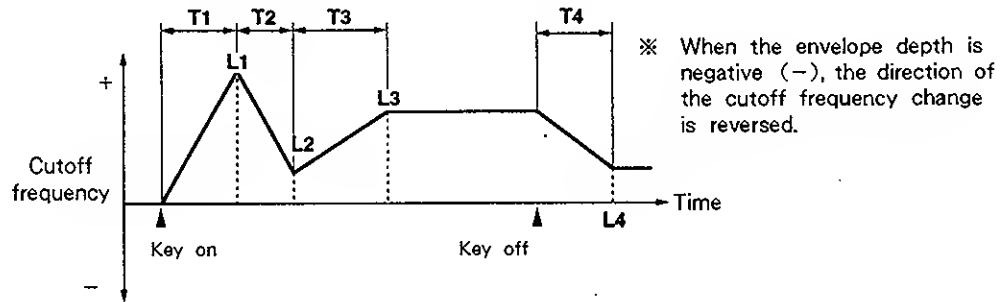

T1 T2 T3 T4 Range: 0 — 127

These determine the time settings (T1, T2, T3 and T4) of the TVF envelope. Each setting represents the time it takes for the cutoff frequency to change from one point to the next; for example, T2 is the time it takes the cutoff frequency to change from L1 to L2. The greater the value, the longer the time it takes to reach the next level.

L1 L2 L3 L4 Range: - 63 — +63

These determine the level settings (L1, L2, L3 and L4) of the TVF envelope. They determine the cutoff frequency of each point. The values set here change the cutoff frequency after adjusting the degree applied from the TVF envelope depth parameter. The greater the value, the higher the cutoff frequency.

TVA

Parameters Selected by TVA (2 Pages).....

Functions of the TVA are is set in these pages.

TVA Page					
I-C2		Level	Velo	U-Time	Pan
TVA		127	+32	+7	0

Level *Tone Level* Range: 0—127

This determines the level (volume) of the Rhythm Tone.

Velo *Velocity Level Sensitivity* Range: -63—+63

This allows you to set to what degree the level changes in response to velocity. When the value is positive (+), the greater the velocity, the greater the level. When the value is negative (-), the lower the velocity, the greater the level.

V-Time *Velocity Time Sensitivity*

Settings: -100/-70/-50/-40/-30/-20/-10/0/+10/+20/+30/+40/+50/+70/+100

This parameter allows you to set the degree to which the time of the entire TVA envelope responds to playing strength (velocity). When the value is positive (+), the greater the velocity, the longer the time. When the value is negative (-), the greater the velocity, the shorter the time. No change results at 0.

Pan *Pan* Settings: L64—0—63R/RND

This determines the stereo position of the Rhythm Tone. The sound position is at the farthest left at L64, at the center at 0, and at the farthest right at 63R. When this is set to RND, the stereo position of the sound image changes at random with each note played.

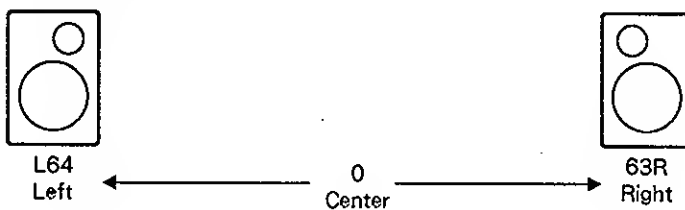

TVA-ENV (TVA Envelope) Page

The way the level changes over time (TVA envelope) is set on this page.

```
I-C2      #  T1| T2| T3| T4| L1| L2| L3|
TVA-ENV #  0| 10| 30| 70|127|100| 85|---
```

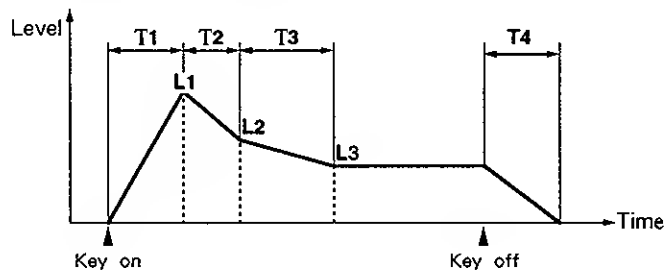

T1 T2 T3 T4 Range: 0 — 127

These determine the time settings (T1, T2, T3 and T4) of the TVA envelope. Each setting represents the time it takes for the level to change from one point to the next; for example, T2 is the time it takes the level to change from L1 to L2. The greater the value, the longer the time it takes to reach the next level.

L1 L2 L3 Range: 0 — 127

These determine the level settings (L1, L2, L3 and L4) of the TVA envelope. The greater the value, the greater the level. The envelope level becomes 0 after the key off in the case of the TVA.

SECTION 5

COMMAND

SECTION 5

Write Mode

This mode features operations such as storing edited data to memory, as well as operations related to organizing the data, such as copying it and transferring it.

※ Functions which are useful in organizing the data are referred to as commands, and operating the commands is referred to as executing the commands.

Operation

- [1] When **WRITE** is pressed from any of the modes, the following display appears in the LCD.

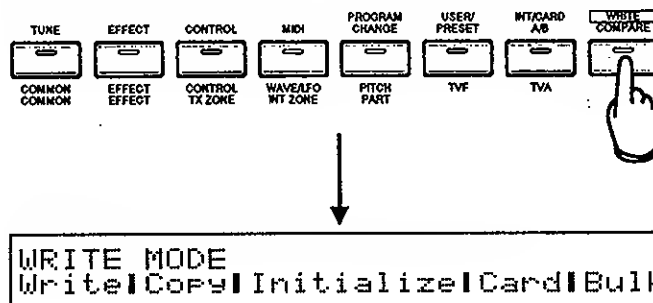

- [2] Select the function (command) to be executed by using either **◀/▶** or one of the parameter sliders.
The selected function name flashes.
- [3] Press **ENTER**. The LCD changes to show the parameter display of the selected function (command).
- [4] The prompt **[Press ENTER]** is displayed in the LCD just before the execution step.
After the desired setting has been made, press **ENTER** to execute the command.

Complete

The display which appears before pressing **WRITE**.

After the "Complete" message has been displayed in the LCD, it returns to the display (or mode) which appeared before **WRITE** was pressed.

- ※ Press **EXIT** to cancel an operation in progress. The display returns to the previous screen each time the button is pressed.
- ※ Display pages are changed by pressing **▲/▼** when "⏏" or "⏏" are displayed in the LCD of each command.

The settings which are executed by operation step [4] are explained in each section below.

● Write

Edited data can be stored in internal memory or on a DATA card. When storing the data in internal memory, make sure the protect function is disabled (OFF).

The LCDs displayed differ depending on the mode which was last selected before **WRITE** was pressed.

- ※ When storing data in internal memory, the write operation cannot be executed if the protect function (P.166) is set to ON. If you try to store data when the protect function is on, a display appears to tell you that it's on, followed by a second display which allows you to turn the protect function off. Press **DEC** to turn off the protect function.
- ※ When writing to a DATA card, turn off the protect switch on the DATA card after inserting the card into the DATA card slot. Turn the protect switch back on after completing the operation in order to protect the data.

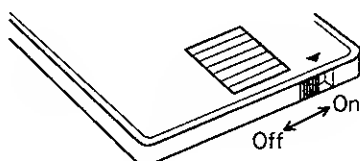

Performance Play/Performce Edit Mode → Write

PERFORM WRITE Performance Write

This operation stores the Performance data currently in the temporary area.

```
PERFORM | from TEMP          [Press ENTER]
WRITE   | to   I01(Syn Lead )
```

Name of the Performance to be stored
 Number of the Performance to be stored (I = Internal, C = DATA card)

[Operation]

The destination Performance number is selected by using **INT/CARD A/B** / **BANK** / **NUMBER** .

INC / **DEC** or Parameter Slider 1.

The name of the selected Performance is displayed within the parentheses.

Patch Play/Patch Edit Mode → Write

PATCH WRITE *Patch Write*

This operation stores the Patch data currently in the temporary area.

```
PATCH  | from TEMP [Press ENTER/COMPARE]
WRITE  | to   I11(A.Piano 1 )
```

Name of the Patch to be stored
Number of the Patch to be stored (I = Internal, C = DATA card)

[Operation]

The destination Patch number is selected by using **INT/CARD A/B**, **BANK**, **NUMBER**, **INC**/**DEC** or Parameter Slider 1.

The name of the selected Performance is displayed within the parentheses.

Pressing **COMPARE** (**WRITE**) switches to the Patch compare function, allowing you to check the sound at the selected destination Patch number.

```
PATCH  | [Press COMPARE]
COMPARE | I11(A.Piano 1 )
```

Name of the Patch to be stored
Number of the Patch to be stored (I = Internal, C = DATA card)

The Patch number can also be changed from this screen. Press **COMPARE** after checking the sound program of the Patch and selecting the destination to write the program to. (The LCD returns to the Patch write operation.)

Rhythm Edit Mode → Write

RHYTHM WRITE *Rhythm Set write*

This operation stores the Rhythm Set data currently in the temporary area.

```
RHYTHM | from TEMP [Press ENTER]
WRITE  | to   CARD
```

Memory type of the destination (INT = Internal, CARD = DATA card)

[Operation]

The destination memory type is selected by using **INT/CARD A/B**, **INC**/**DEC** or Parameter Slider 1.

● Copy

This operation copies Performance data, Patch data and Tone data to the temporary area.

Performance Play/Performance Edit Mode → Copy

Performance Part Copy

The setting of a single specific Part of a Performance is copied to one Part of the Performance in the temporary area.

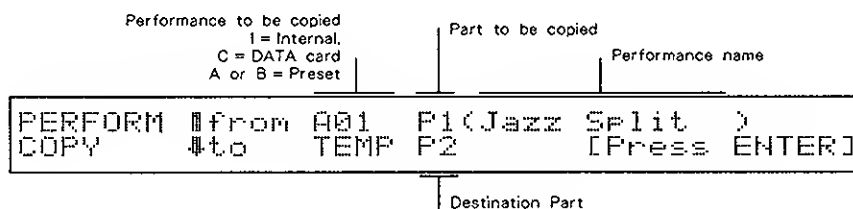

【Operation】

The destination Patch number is selected by using **USER/PRESET** / **INT/CARD A/B** / **BANK** / **NUMBER** , **INC** / **DEC** or Parameter Slider 1. The name of the selected Performance is displayed within the parentheses.

The Part to be copied is selected by using Parameter Slider 2. It can also be selected by first moving the cursor with the **◀** / **▶** buttons, then using **INC** or **DEC** .

The Part of the copy destination can be selected by using the **PART SWITCH** buttons (1 — 8).

Performance Common Copy

This operation copies the settings of the Performance name, key mode and effect section from the specified Performance (which has been already stored) to the Performance in the temporary area.

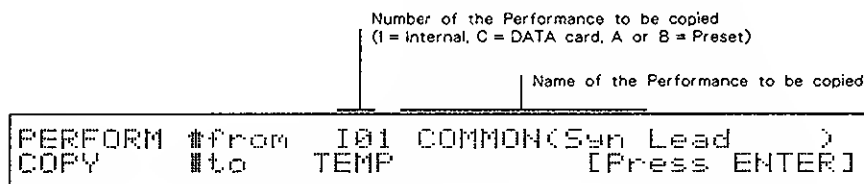

【Operation】

The Performance number to be copied is selected by using **USER/PRESET** / **INT/CARD A/B** / **BANK** / **NUMBER** , **INC** / **DEC** or Parameter Slider 1.

The name of the selected Performance is displayed within the parentheses.

Patch Play/Patch Edit Mode → Copy

Patch Tone Copy

The data of a single specific Tone of a Patch is copied to a Tone of the Patch in the temporary area.

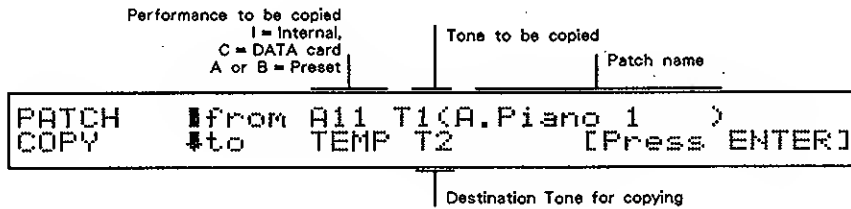

[Operation]

The Patch to be copied is selected by using **USER/PRESET** / **INT/CARD A/B** / **BANK** / **NUMBER** / **INC** / **DEC** or Parameter Slider 1. The name of the selected Patch is displayed within the parentheses.

The Tone to be copied is selected by using Parameter Slider 2. It can also be selected by first moving the cursor with the **◀** / **▶** buttons, then using **INC** or **DEC**.

The Tone of the copy destination can be selected by using the **TONE SELECT** buttons (1 — 4).

Patch Common Copy

The parameters which are common in a Tone from a specific Patch (which has already been stored) are copied to the Patch in the temporary area.

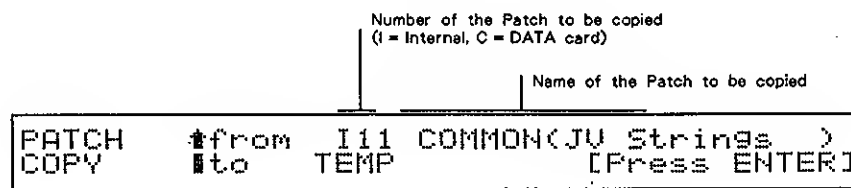

※ The contents copied in this operation include effect and key assign (POLY/SOLO) settings. (Refer to the Patch Edit mode, P.83)

[Operation]

The Patch number to be copied is selected by using **USER/PRESET** / **INT/CARD A/B** / **BANK** / **NUMBER** / **INC** / **DEC** or Parameter Slider 1.

The name of the selected Performance is displayed within the parentheses.

Rhythm Edit Mode → Copy

Rhythm Key Copy

This operation copies the Rhythm Tone data (which is assigned to a specific key in the Rhythm Set) to a specified key of the Rhythm Set in the temporary area.

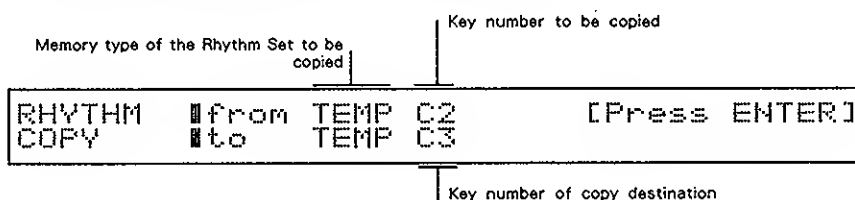

【Operation】

The memory type to be copied to is selected by using **USER/PRESET** / **INT/CARD A/B** / **BANK** / **NUMBER** , **INC** / **DEC** or Parameter Slider 1.

The key number to be copied is selected by using Parameter Slider 2. It can also be selected by first moving the cursor with the **◀** / **▶** buttons, then using **INC** or **DEC** .

The destination key number is selected by pressing the desired key on the keyboard.

● Initialize

※ See P.175, 180 for the initialized data and the factory setting data.

Performance Play/Performance Edit Mode → Initialize

PERFORM INIT *Performance Initialize*

This operation initializes the Performance data in the temporary area to the standard parameter values (initialize data).

```
PERFORM  █
INIT      █                               [Press ENTER]
```

Patch Play/Patch Edit Mode → Initialize

PATCH INIT *Patch Initialize*

This operation initializes the Patch data in the temporary area to the standard parameter values (initialize data).

```
PATCH    █
INIT     █                               [Press ENTER]
```

Rhythm Edit Mode → Initialize

RHYTHM KEY INIT *Rhythm Key Initialize*

This operation initializes the Rhythm Tones assigned to specific keys in the Rhythm Set data to the standard parameter value (initialize data).

```
RHYTHM  █Key=C2
KEY INIT█                               [Press ENTER]
```

[Operation]

The key to be initialized is selected by pressing the corresponding key on the keyboard or by pressing one of the **TONE SELECT** buttons 1 — 4.

RHYTHM SET INIT *Rhythm Set Initialize*

This operation initializes the Rhythm Set data in the temporary area to the factory set data.

```
RHYTHM  █
SET INIT█                               [Press ENTER]
```

Card

This command transfers the data between internal memory and DATA card or PCM card. When this command is selected, a display appears allowing you to select the type of data transfer.

```
DATA/PCM Card
Int→Card|Card→Int|Int↔Card|PCM Card
```

[Operation]

Select the desired operation by using / or Parameter Slider 1 (the selected operation flashes), then press **ENTER**.

NOTE

You can create Performances on the JV-80 by combining Patches from both internal memory and DATA card. When copying Performance data created in this way from internal memory to DATA card or vice versa, take care to avoid possible problems, such as described in the example below.

(Example) In this example, a Performance numbered I01 has been programmed, and in it Part 1 has been assigned to Patch I12 and Patch C11 has been assigned to Part 2. When the Performance is copied from internal memory to DATA card, it is stored as "C01" in the DATA card. In this operation, the Patch of Part 1 is stored as "C12" and the Patch of Part 2 stays the same as C11.

If this copied Performance is copied again, this time from DATA card back to internal memory, the Performance is stored as "I01," and Part 1 is stored as "I12" to internal memory. However, Part 2 is now stored as "I11." Therefore, even though the Performance number is the same as that of the original data, the Patch number set for Part 2 has been changed.

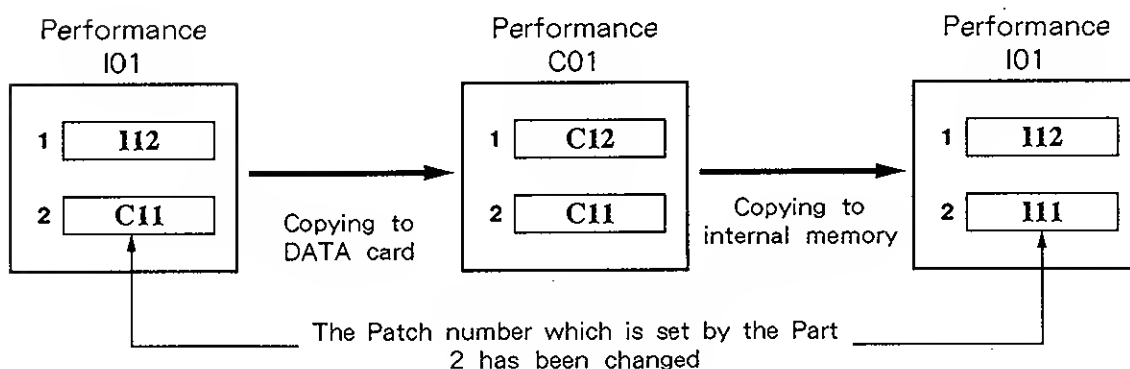

Execute the bulk dump function (P.164) when you want store the internal data as it is, without being changed.

COPY INTERNAL → DATA CARD

```

CARD      █ INTERNAL→DATA CARD
COPY      █                               [Press ENTER]
    
```

Copy Internal → Data Card

This operation copies all Performance data, Patch data and Rhythm data in internal memory to the DATA card.

- ※ If a new DATA card, or a DATA card which has been used for another musical instrument, is used when this command is executed, the DATA card will be formatted so that JV-80 data can be stored on it.

COPY DATA CARD → INTERNAL

```

CARD      █ DATA CARD→INTERNAL
COPY      █                               [Press ENTER]
    
```

Copy Data Card → Internal

This operation copies all Performance data, Patch data and Rhythm data in the DATA card to internal memory.

COPY INTERNAL ↔ DATA CARD

```

CARD      █ INTERNAL↔DATA CARD
COPY      █                               [Press ENTER]
    
```

Copy Internal ↔ Data Card

The Performance data, Patch data and Rhythm data in internal memory is switched with that stored on the DATA card.

PCM CARD

The media to be copied from (EXP = Expansion board, CARD = PCM card)

Patch number	Patch name
--------------	------------

```

LOAD      █ from CARD 001(PATCH   NAME)
PARAM     █                               [Press ENTER]
    
```

LOAD PARM *Load PCM Card Parameters*

There are some PCM cards (SO-PCM1 series) or expansion boards (SR-JV80 series) which already contain Patch data. This command copies the data to the temporary area.

[Operation]

The media to be copied from is selected with the **INC** / **DEC** buttons or Parameter Slider 1.

The Tone number to be copied is selected by using Parameter Slider 2. It can also be selected by first moving the cursor with the **◀** / **▶** buttons, then using **INC** or **DEC**. (The name of the selected Tone appears in parentheses.)

The tone is selected by pressing the desired Key on the Keyboard.

● Bulk (Bulk Dump)

This operation transfers program data of the JV-80 (via MIDI) to another JV-80 or devices which can record bulk data, such as the MC-50 sequencer.

Bulk dump transmits the Patch data and Tone data in the internal memory (or temporary area) via MIDI. The unit number has to match the MIDI channel of both the receiving and sending devices. (The unit number is set by pressing **MIDI** from the SYS-EX MIDI page.)

※ The data is transferred by a one-way method and involves no "handshaking".

When this command is selected, a display appears allowing you to select the type of memory from which the data will be transferred.

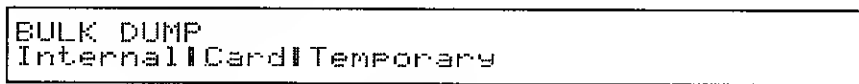

[Operation]

Select the operation by using **◀/▶** or Parameter Slider 1 (the selected operation flashes), then press **ENTER**.

When "Temporary" is selected, a display appears allowing you to select the unit of the data to be transferred.

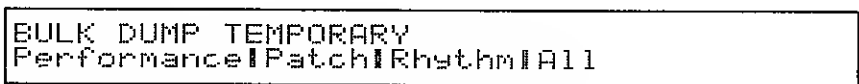

In this case as well, select the operation by using **◀/▶** or Parameter Slider 1 (the selected operation flashes), then press **ENTER**.

When the type of data to be transferred has been determined, press **ENTER**. A "Now Sending" message is displayed in the LCD as the data is transferred. A moment later, a "Complete" message appears, indicating that the data transfer has been completed.

INTERNAL DATA

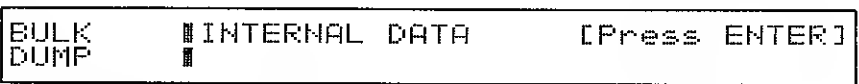

Internal Data

This operation transfers all data stored in the internal memory of the JV-80. The data transferred includes Performance data, Patch data and Rhythm Set data.

CARD DATA

```
BULK      ||CARD DATA      [Press ENTER]
DUMP      ||                |
```

Card Data

This operation transfers all data stored in a DATA card. The data transferred includes Performance data, Patch data and Rhythm Set data.

PERFORMANCE TEMP

```
BULK      ||PERFORMANCE TEMP [Press ENTER]
DUMP      ||                |
```

Performance Temporary

This operation transfers the Performance data currently in the temporary area.

PATCH TEMP

```
BULK      ||PATCH TEMP      [Press ENTER]
DUMP      ||                |
```

Patch Temporary

This operation transfers the Patch data currently in the temporary area.

RHYTHM TEMP

```
BULK      ||RHYTHM TEMP      [Press ENTER]
DUMP      ||                |
```

Rhythm Temporary

This operation transfers the Rhythm Set data currently in the temporary area.

ALL TEMP

```
BULK      ||ALL TEMP      [Press ENTER]
DUMP      ||                |
```

All Temporary

This operation transfers the Performance data, the Patch data of each Part and the Rhythm Set data currently in the temporary area.

● Protect

This function prevents data stored in internal memory from being inadvertently erased or altered.

WRITE PROTECT

```
WRITE  | ON
PROTECT |
```

Write Protect ON/OFF

The protect function is effective when this is set to ON, and is disabled when set to OFF. Be sure to turn it OFF when writing Patch data and Tone data from the card or temporary area to internal memory. Also turn it off when overwriting the internal memory with bulk data received over MIDI. This is always set to ON as a default setting (when the power is turned on).

【Operation】

Change the protect ON/OFF setting by using **INC** / **DEC**, or Parameter Slider 1.

SECTION 6

REFERENCE

SECTION 6

1. Error Messages

When operations have been incorrectly executed, or when some unexpected condition arises, an error message will be displayed. Check the displayed error message and implement the suggested solution (or solutions) in this section.

All the messages listed below are displayed for approximately 1.5 seconds, after which the LCD returns to the previous display.

● Internal RAM Write Protect

Problem: The internal memory write-protect function is on and data cannot be written or stored.

Solution: After this message is displayed, the LCD automatically switches to the write-protect display. Set the protect function to OFF from this display.

● Internal RAM Read Error

Problem: The data of the internal memory has somehow been corrupted or destroyed.

Solution: Consult with your nearest Roland Service Station.

● Internal Battery Low

Problem: The internal backup battery has run down.

Solution: Consult with your nearest Roland Service Station.

● DATA Card Not Ready

Problem: The DATA card has not been inserted into the DATA card slot or has not been inserted correctly.

Solution: Insert the DATA card correctly and securely.

● DATA Card Not Properly Formatted

Problem: The DATA card inserted has not been properly formatted for use with the JV-80.

Solution: Format the card from the Write mode (P.162).

● DATA Card Write Protect

Problem: The protect switch of the DATA card is on and data cannot be stored on the card.

Solution: Set the protect switch of the DATA card to off (P.155), then perform the desired operation again.

● DATA Card Read Error

Problem: The data of the DATA card has somehow been corrupted or destroyed.

Solution: Consult with your nearest Roland Service Station.

● DATA Card Battery Low

Problem: The DATA card backup battery has run down.

Solution: Transfer the data to another DATA card, then replace the battery in the original card.

● PCM Card Not Ready

Problem: The PCM card has not been inserted into the PCM card slot or has not been inserted correctly.

Solution: Insert the PCM card correctly and securely.

● PCM Card Not Properly Formatted

Problem: A PCM card not designed for use with the JV-80 has been inserted into the PCM card slot.

Solution: Use only a proper PCM card.

● Expansion Board Not Ready

Problem: Without a properly installed expansion board, a Tone (or Patch) which uses waveforms from the expansion board cannot be called up.

Solution: Install the expansion board.

● MIDI Communication Error

Problem: Either an excessive amount of data was received at once, or the active sensing function was cut off.

Solution: Do not attempt to continuously transmit large amounts of data (like program change messages) that require processing on reception and, hence, take more time than usual. Also make sure that all MIDI cables are connected correctly.

● BULK DUMP: MIDI Buffer Full

Problem: Excessive data has been transmitted at once by the bulk dump function.

Solution: Make adjustments to the exclusive data so that it is sent in several "packets" of smaller amounts.

● BULK DUMP: Check Sum Error

Problem: The checksum value of the bulk dump is incorrect.

Solution: Correct the exclusive data.

● BULK DUMP: Internal RAM Write Protect

Problem: The internal memory write-protect function is on and data received during execution of the bulk dump function cannot be written or stored.

Solution: Set the protect function to OFF in the Write mode (P.166), then perform the operation again.

● BULK DUMP: DATA Card Not Ready

Problem: A DATA card has not been inserted and the data received by the bulk dump function cannot be written or stored.

Solution: Insert a DATA card correctly and securely into the DATA card slot.

● BULK DUMP: Improper DATA Card

Problem: A DATA card not properly formatted for use with the JV-80 has been inserted and the data received by bulk dump cannot be written or stored.

Solution: After formatting the DATA card from the Write mode (P.162), perform the operation again.

● BULK DUMP: DATA Card Write Protect

Problem: The protect switch of the DATA card is on and data received during execution of the bulk dump function could not be written or stored.

Solution: Set the protect switch of the DATA card to off (P.155), then perform the operation again.

2. Troubleshooting

Check through the following situations and conditions when your JV-80 fails to operate properly.

■ No sound

- Check that the JV-80, amplifier and mixer are all turned on.
- Check that all the devices are connected correctly and securely.
- Check that the connecting cables are not defective.
- Check whether the sound is output through a connected set of headphones. If you can hear the sound normally through the headphones, the connected device or cable are probably the cause of the problem.
- Check that the volume of the amplifier, mixer or external MIDI sound source are set to suitable levels.
- Check that the volume of JV-80 is set to a suitable level.

For the internal sound source, check the following:

- The position of the master volume slider
- The Part level value which is set for the Part of a Performance
- The Patch level value which is set for a Patch
- TVA level value which is set for the Tone of a Patch or a Rhythm Tone
- The position of the pedal or slider when CC7/VOLUME is assigned to Pedal 1/2 or C1
- The value of the volume data received via MIDI IN

For connected MIDI devices, check the following:

- The transmit volume setting which is made for the transmit zone of a Performance
- The position of the pedal or slider when CC7/VOLUME is assigned to Pedal 1/2 or C1
- Check that the local switch is on:
 - The setting of the local switch in the system common parameters
 - The setting of the local switch which is set for the internal zone of a Performance
- Check that the receive switch which is set for the Part of a Performance is on.
- Check that the transmit switch which is set for the transmit zone of a Performance is on.

- Check that the Patch transmit channel of the system parameters is on.
- Check that the Tone switch which is set for the Tone of a Patch is on.
- Check that the range of the zone has been properly set:
 - The key range value which is set for the transmit or internal zone, when the key mode of the Performance is set to zone
 - The velocity range value which is set for the Tone when the velocity switch of a Patch is on
- Check that the MIDI channel has been set properly:
 - The Patch transmit/receive channel value which is set in the system common parameters
 - Transmit channel value which is set by the transmit zone of the Performance
 - Receive channel value which is set for the Part of a Performance
- Sound may not be produced if: 1) the cutoff is set to 0 and the TVF filter type for the Tone of a Patch or a Rhythm Tone is set to LPF, or 2) the cutoff is set to 127 and the filter type is set to HPF.

Check the following:

- TVF cutoff value
- TVF envelope depth
- The velocity sensitivity value and the key follow setting of the TVF envelope
- The level setting of TVF envelope
- The depth setting and the controller position when the modulation/aftertouch/expression control parameter is set to cutoff
- Check that the TVA level of the Patch Tone or Rhythm Tone is set to 0.

Check the following:

- Dry level value which is set by the effect send
- TVA level value
- The velocity sensitivity value and the key follow setting of the TVA envelope
- The level setting of TVA envelope
- The depth setting and the controller position when the modulation/aftertouch/expression control parameter is set to level
- The Tone delay time value

- The sound range may be limited depending on the wave selected.

Check the following:

- Transpose value of the system common parameters
- Transpose value which is set for the internal zone of a Performance
- Coarse tune value which is set for the Part of a Performance
- Coarse tune value which is set for the Tone of a Patch
- Coarse tune value which is set for the Rhythm Tone
- Check that the JV-80 is not in the ROM play mode. The internal sounds of the JV-80 cannot sound from play data from the keyboard or MIDI IN when the instrument is in the ROM play mode.

■ Volume cannot be controlled

- Check that either pedal 1/2 or C1 is assigned to CC7/VOLUME.
- Check that the receiving switch for the volume is not off.

Check the following:

- The receive volume setting which is set by MIDI receive in the system common parameters
- The receive volume setting which is set for the Part of a Performance
- The volume setting which is set for the pedal of the Patch Tone
- The volume is not transmitted even though the value of the transmit volume of the transmit zone is changed in the Performance Edit mode.

■ Dynamic changes in the sound do not respond correctly or as you expect them to.

- Check the velocity sensitivity settings:
 - The value of the velocity curve/sensitivity and maximum velocity, which are set in transmit/internal zone of the Performance
 - The value of the TVA velocity curve/sensitivity, which are set for the Rhythm Tone of a Patch.

■ The sound is distorted

- Check the levels of the amplifier and mixer and the master volume of the JV-80 are set properly.
- When the Part level parameter of a Performance is set too high, the sound sometimes may be distorted.
- When the TVA level or the resonance value set for a Patch Tone or Rhythm Tone is set too high, the sound sometimes may be distorted.

■ The pitch is wrong or does not change

- Check that the tune settings are correct:
 - The master tune/transpose values of the system parameters
 - The transpose value set for the internal zone of a Performance
 - The coarse tune/fine tune values set for the Part of a Performance
 - The coarse tune/fine tune/random pitch values set for the Tone of a Patch or a Rhythm Tone
 - The pitch key follow value set for the Tone of a Patch
 - The pitch envelope value set for the Tone of a Patch or a Rhythm Tone
 - The tuning value of the external MIDI sound source
- Check that the pitch bender has not been moved

Check the following:

- The position of the bender lever
- The position of pedals 1/2 and C1 when the assignment of pedal 1/2 and C1 are set to BEND-UP/BEND-DOWN
- The pitch bend value received via MIDI IN
- The bender range value which is set for the Patch
- The bender range value which is set for the Rhythm Tone
- The bender range value of the external MIDI sound source

- Check that the receiving switch of the pitch bender is on.

Check the following:

- The bender setting which is set by the transmit/receive MIDI functions of the system common parameters
- The bender range value which is set for the Patch
- The bender range value which is set for the Rhythm Tone
- The bender range value/receiving switch of the external MIDI sound source

● Check that the effects and LFO are correctly set

Check the following:

- The chorus value which is set for the Performance/Patch
- The analog feel value which is set for the Patch
- The switch/depth value of FXM which is set for the Tone of a Patch
- The pitch LFO depth value which is set for the Tone of a Patch
- The depth value and the controller position of the modulation/ aftertouch/expression control which is set for the Tone of a Patch, when the parameter is set to pitch LFO

- It may happen that the sounding pitch range is limited, or that a Tone doesn't deviate from a certain pitch range, or that the tuning sounds off, depending on the selected wave.

■ The controllers do not work

- Check the mode/assign settings of pedals 1/2 and C1, which are set in the system common parameters.

- Check the transmission/receiving switch of the controller.

Check the following:

- The MIDI transmit/receive settings made in the system common parameters
- The receive volume/hold 1 settings made for the Part of a Performance
- The volume/hold 1 settings made for the pedal of the Tone of a Patch

- Check the modulation/aftertouch/expression control settings made for the Tone of a Patch. The effect is not applied when the parameter is set to off or the depth is set to 0.

■ The sound color does not change or program change messages are not sent

- Check that the switches which allow sending and receiving of program change messages are not set to OFF:

- The program change setting for MIDI transmit/receive which is set in the system common parameters
- The transmit program change value which is set for the transmit zone of a Performance

- The receive program change value which is set for the Part of a Performance

- Check that the MIDI channel settings are correct:

- The control channel value which is set in the system common parameters

- The Patch transmit/receive channel value which is set in the system common parameters

- The transmit channel value which is set for the transmit zone of a Performance

- The receive channel value which is set for the Part of a Performance

- The layer/zone key mode and the single key mode of a Performance may have different settings for the program change to be transmitted and the MIDI channel.

- When the Patch select display is selected in the Performance Play mode, the Performance cannot be changed.

- Check that the Edit mode has not been selected:

- Changing Performances or receiving program changes is not possible in the Performance Edit mode.

- Changing Patches or receiving program changes is not possible in the Patch Edit mode.

- Changing Rhythms or receiving program changes is not possible in the Rhythm Edit mode.

- From the Performance Edit mode, program change messages cannot be transmitted even though the value of the transmit program change of the transmit zone has been changed.

■ The effects do not work

- Check that the effect switch is on:

- The chorus/reverb switch on the front panel

- The chorus/reverb switch setting which is made for the Part of a Performance

- Check that the setting of the Performance and the effect of a Patch have been made correctly. The effect is not applied when the chorus/reverb level is set to 0.

- Check that the setting of the Patch and Rhythm Tone have been made correctly. The effect is not applied when the chorus/reverb send, which is set by the effect send parameter, is set to 0.

■ Portamento does not work

- Check that the portamento switch, which is set for the Patch, is on.
- When the portamento mode for the Patch is set to legato, portamento is not applied unless you actually play the keyboard with legato technique; that is, holding down one key and not releasing it until after the next key has been pressed.
- Portamento is not applied to Rhythm Tones.

■ The sound is muted

- The maximum Polyphony of the JV-80 is twenty-eight. Decrease the number of Tones you are using or adjust the Partial reserve.
- When the key assign parameter of the Patch is set to solo, only a single Tone sounds even when several keys are played.
- If the mute group of a Rhythm Tone is on, the sound which has been sounding is muted when another sound from the same group is played.

■ The Tone of a Patch cannot be edited as intended

- Check that the condition of the Tone select and the Tone number to be edited match.
- The sound doesn't change when editing a Tone whose Tone switch has been turned off.

■ The Rhythm cannot be edited as intended

- Check that the key which is being edited and the sounding key match. The key to be edited isn't affected by the note data received via MIDI IN.
- No sound results when editing a Tone whose Tone switch has been turned off.

■ Card cannot be used

- Cards which have not been formatted for use with the JV-80 cannot be used. Format the DATA card by transferring the internal data to the card (the card will automatically be formatted):
- PCM cards which have not been designed for use with the JV-80 cannot be used.

■ Data cannot be transferred by MIDI exclusive messages

- Check that the receive exclusive switch, which is set in the system common parameters, is on.
- Check that the unit number, which is set in the system common parameters, is correct. Match it to the unit number of the connected device.
- The temporary data will not be changed, even though the data is transferred by exclusive messages to internal memory or DATA card. Transfer to the temporary area or switch the Performance/Patch by program change after transferring the data by exclusive message.
- Check that a DATA card has been inserted. Data cannot be stored on the DATA card if it has not been properly inserted.
- Check that the DATA card has been formatted for use with the JV-80. Data cannot be stored on the DATA card if it has not been properly formatted for the JV-80.
- Check that the write-protect switch is on. When transferring data to either the internal memory or DATA card, the data cannot be written unless the corresponding write-protect switch is set to off.

3. Waveform List

No.	Wave Name	No.	Wave Name	No.	Wave Name	No.	Wave Name
1	Ac Piano 1	41	SYN VOX 1	81	Rattles	121	REV SN 4
2	SA Rhodes 1	42	SYN VOX 2	82	Tin Wave	122	REV Kick 1
3	SA Rhodes 2	43	Male Ooh	83	Spectrum 1	123	REV Cup
4	E.Piano 1	44	ORG VOX	84	808 SNR 1	124	REV Tom
5	E.Piano 2	45	VOX Noise	85	90's Snare	125	REV Cow Bell
6	Clav 1	46	Soft Pad	86	Piccolo SN	126	REV TAMB
7	Organ 1	47	JP Strings	87	LA Snare	127	REV Conga
8	Jazz Organ	48	Pop Voice	88	Whack Snare	128	REV Maracas
9	Pipe Organ	49	Fine Wine	89	Rim Shot	129	REV Crash 1
10	Nylon GTR	50	Fantasynth	90	Bright Kick		
11	6STR GTR	51	Fanta Bell	91	Verb Kick		
12	GTR HARM	52	ORG Bell	92	Round Kick		
13	Mute GTR 1	53	Agogo	93	808 Kick		
14	Pop Strat	54	Bottle Hit	94	Closed HAT 1		
15	Stratus	55	Vibes	95	Closed HAT 2		
16	SYN GTR	56	Marimba wave	96	Open HAT 1		
17	Harp 1	57	Log Drum	97	Crash 1		
18	SYN Bass	58	DIGI Bell 1	98	Ride 1		
19	Pick Bass	59	DIGI Chime	99	Ride Bell 1		
20	E.Bass	60	Steel Drums	100	Power Tom Hi		
21	Fretless 1	61	MMM VOX	101	Power Tom Lo		
22	Upright BS	62	Spark VOX	102	Cross Stick1		
23	Slap Bass 1	63	Wave Scan	103	808 Claps		
24	Slap & Pop	64	Wire String	104	Cowbell 1		
25	Slap Bass 2	65	Lead Wave	105	Tambourine		
26	Slap Bass 3	66	Synth Saw 1	106	Timbale		
27	Flute 1	67	Synth Saw 2	107	CGA Mute Hi		
28	Trumpet 1	68	Synth Saw 3	108	CGA Mute Lo		
29	Trombone 1	69	Synth Square	109	CGA Slap		
30	Harmon Mute1	70	Synth Pulse1	110	Conga Hi		
31	Alto Sax 1	71	Synth Pulse2	111	Conga Lo		
32	Tenor Sax 1	72	Triangle	112	Maracas		
33	French 1	73	Sine	113	Cabasa Cut		
34	Blow Pipe	74	ORG Click	114	Cabasa Up		
35	Bottle	75	White Noise	115	Cabasa Down		
36	Trumpet SECT	76	Wind Agogo	116	REV Steel DR		
37	ST.Strings - R	77	Metal Wind	117	REV Tin Wave		
38	ST.Strings - L	78	Feedbackwave	118	REV SN 1		
39	Mono Strings	79	Anklungs	119	REV SN 2		
40	Pizz	80	Wind Chimes	120	REV SN 3		

4. Initialize Data

Performance

Common	Performance Name	INITIAL DATA	Key Mode	SINGLE
	Chorus Type	CHO1	Chorus Level	60
	Chorus Rate	60	Chorus Depth	80
	Chorus Feedback	0	Chorus Output	MIX
	Reverb Type	STAGE1	Reverb Level	100
	Reverb Time	80	Delay Feedback	0

		Part							
		1	2	3	4	5	6	7	8
Transmit Zone	Key Range Lower	C - 1	C - 1	C - 1	C - 1	C - 1	C - 1	C - 1	C - 1
	Key Range Upper	G9	G9	G9	G9	G9	G9	G9	G9
	Key Transpose	0	0	0	0	0	0	0	0
	Max Velocity	127	127	127	127	127	127	127	127
	Velocity Sense	+32	+32	+32	+32	+32	+32	+32	+32
	Velocity Curve	1	1	1	1	1	1	1	1
	Transmit Channel	1	2	3	4	5	6	7	8
	Program Change	OFF	OFF	OFF	OFF	OFF	OFF	OFF	OFF
	Transmit Volume	OFF	OFF	OFF	OFF	OFF	OFF	OFF	OFF
	Transmit Pan	OFF	OFF	OFF	OFF	OFF	OFF	OFF	OFF
	Transmit Switch	ON	OFF	OFF	OFF	OFF	OFF	OFF	OFF
Internal Zone	Key Range Lower	C - 1	C - 1	C - 1	C - 1	C - 1	C - 1	C - 1	C - 1
	Key range Upper	G9	G9	G9	G9	G9	G9	G9	G9
	Key Transpose	0	0	0	0	0	0	0	0
	Max Velocity	127	127	127	127	127	127	127	127
	Velocity Sense	+32	+32	+32	+32	+32	+32	+32	+32
	Velocity Curve	1	1	1	1	1	1	1	1
	Local Switch	ON	OFF	OFF	OFF	OFF	OFF	OFF	OFF
Part	Patch Number	I - 11	I - 12	I - 13	I - 14	I - 15	I - 16	I - 17	INT
	Level	127	127	127	127	127	127	127	127
	Pan	0	0	0	0	0	0	0	0
	Coarse Tune	0	0	0	0	0	0	0	0
	Fine Tune	0	0	0	0	0	0	0	0
	Receive Channel	1	2	3	4	5	6	7	10
	Voice Reserve	0	0	0	0	0	0	0	0
	Chorus Switch	ON	ON	ON	ON	ON	ON	ON	ON
	Reverb Switch	ON	ON	ON	ON	ON	ON	ON	ON
	Receive P.C	ON	ON	ON	ON	ON	ON	ON	ON
	Receive Volume	ON	ON	ON	ON	ON	ON	ON	ON
Receive Hold - 1	ON	ON	ON	ON	ON	ON	ON	ON	
Receive Switch	ON	ON	ON	ON	ON	ON	ON	ON	

■ Patch

Common	Patch Name	INITIAL DATA		
	Patch Level	127	Patch Pan	0
	Velocity Range Switch	OFF		
	Chorus Type	CHO1	Chorus Level	60
	Chorus Rate	60	Chorus Depth	80
	Chorus Feedback	0	Chorus Output	MIX
	Reverb Type	STAGE2	Reverb Level	100
	Reverb Time	60	Delay Feedback	0
	Analog Feel Depth	0		
	Bend Range Down	-2	Bend Range Up	+2
	Assign Mode	POLY	Solo Legato	OFF
	Portamento Switch	OFF	Portamento Mode	NORMAL
	Portamento Type	TIME	Portamento Time	50

		Tone			
		1	2	3	4
	Velocity Range Lower	0	0	0	0
	Velocity Range Upper	127	127	127	127
	Dry Level	127	127	127	127
	Chorus Level	127	127	127	127
	Reverb Level	127	127	127	127
	Receive Volume	ON	ON	ON	ON
	Receive Hold - 1	ON	ON	ON	ON
Control	Modulation Control Dest 1 - 4	OFF	OFF	OFF	OFF
	Modulation Control Depth 1 - 4	0	0	0	0
	Aftertouch Control Dest 1 - 4	OFF	OFF	OFF	OFF
	Aftertouch Control Depth 1 - 4	0	0	0	0
	Expression Control Dest 1 - 4	OFF	OFF	OFF	OFF
	Expression Control Depth 1 - 4	0	0	0	0
Wave	Group	INT	INT	INT	INT
	Number	1	1	1	1
	Switch	ON	OFF	OFF	OFF
	FXM Switch	OFF	OFF	OFF	OFF
	FXM Depth	1	1	1	1
LFO 1/2	Waveform	TRIANGLE	TRIANGLE	TRIANGLE	TRIANGLE
	Synchro	ON	ON	ON	ON
	Rate	60	60	60	60
	Offset	0	0	0	0
	Delay	0	0	0	0
	Fade Mode	IN	IN	IN	IN
	Fade Time	0	0	0	0
	Pitch LFO Depth	0	0	0	0
	TVF LFO Depth	0	0	0	0
	TVA LFO Depth	0	0	0	0

		Tone			
		1	2	3	4
Pitch	Shift Coarse	0	0	0	0
	Shift Fine	0	0	0	0
	Random Pitch Depth	0	0	0	0
	Key Follow	+100	+100	+100	+100
	Envelope Depth	0	0	0	0
	Envelope Velocity Sense	0	0	0	0
	Env Attack Time Velocity Sense	0	0	0	0
	Env Release Time Velocity Sense	0	0	0	0
	Envelope Time Key Follow	0	0	0	0
	Envelope T1	0	0	0	0
	Envelope T2	0	0	0	0
	Envelope T3	0	0	0	0
	Envelope T4	0	0	0	0
	Envelope L1	0	0	0	0
	Envelope L2	0	0	0	0
	Envelope L3	0	0	0	0
	Envelope L4	0	0	0	0
TVF	Filter Type	LPF	LPF	LPF	LPF
	Cutoff	127	127	127	127
	Resonance	0	0	0	0
	Resonance Mode	SOFT	SOFT	SOFT	SOFT
	Cutoff Key Follow	0	0	0	0
	Envelope Depth	0	0	0	0
	Envelope Velocity Curve	1	1	1	1
	Envelope Velocity Sense	0	0	0	0
	Env Attack Time Velocity Sense	0	0	0	0
	Env Release Time Velocity Sense	0	0	0	0
	Envelope Time Key Follow	0	0	0	0
	Envelope T1	0	0	0	0
	Envelope T2	0	0	0	0
	Envelope T3	0	0	0	0
	Envelope T4	0	0	0	0
	Envelope L1	0	0	0	0
	Envelope L2	0	0	0	0
Envelope L3	0	0	0	0	
Envelope L4	0	0	0	0	

		Tone			
		1	2	3	4
TVA	Tone Level	127	127	127	127
	Level Key Follow	0	0	0	0
	Level Velocity Curve	1	1	1	1
	Envelope Velocity Sense	+32	+32	+32	+32
	Pan Offset	0	0	0	0
	Pan Key Follow	0	0	0	0
	Tone Delay Mode	NORMAL	NORMAL	NORMAL	NORMAL
	Tone Delay Time	0	0	0	0
	Env Atteck Time Velocity Sense	0	0	0	0
	Env Release Time Velocity Sence	0	0	0	0
	Envelope Time Key Follow	0	0	0	0
	Envelope T1	0	0	0	0
	Envelope T2	0	0	0	0
	Envelope T3	0	0	0	0
	Envelope T4	50	50	50	50
	Envelope L1	127	127	127	127
	Envelope L2	127	127	127	127
	Envelope L3	127	127	127	127

■ Rhythm Tone

	Dry Level	127
	Chorus Level	127
	Reverb Level	127
Wave	Group	INT
	Number	84
	Switch	ON
	Mute Group	OFF
	Envelope Mode	NO-SUS
Pitch	Coarse Tune	C4
	Fine Tune	0
	Random Pitch Depth	0
	Envelope Depth	0
	Envelope Velocity Sense	0
	Envelope Time Velocity Sense	0
	Bend Range	0
	Envelope T1	0
	Envelope T2	0
	Envelope T3	0
	Envelope T4	0
	Envelope L1	0
	Envelope L2	0
	Envelope L3	0
Envelope L4	0	
TVF	Filter Type	LPF
	Cutoff	127
	Resonance	0
	Resonance Mode	SOFT
	Envelope Depth	0
	Envelope Velocity Sense	0
	Envelope Time Velocity Sense	0
	Envelope T1	0
	Envelope T2	0
	Envelope T3	0
	Envelope T4	0
	Envelope L1	0
	Envelope L2	0
	Envelope L3	0
Envelope L4	0	

TVA	Tone Level	127
	Envelope Velocity Sense	+32
	Envelope Time Velocity Sense	0
	Pen Offset	0
	Envelope T1	0
	Envelope T2	0
	Envelope T3	127
	Envelope T4	50
	Envelope L1	127
	Envelope L2	127
	Envelope L3	127

5. Factory Setting

Internal

● Performance

No	Name
I01	Syn Lead
I02	Encounter X
I03	Analog Pad
I04	Stab Stab II
I05	A.Piano+STR
I06	Analog Brass
I07	Steel Pad
I08	Brass ComeOn
I09	HauntedHouse
I10	Jazz Combo
I11	Strat Pad
I12	Movie Stab
I13	Ice Church
I14	Diamond Dust
I15	House Hammer
I16	TUTORIAL

● Patch

No	Name	No	Name
I11	JV Strings	I51	Mute TP mod
I12	BrightGuitar	I52	JV Heaven
I13	Von Greece	I53	Tria Bells
I14	Brass Sect.	I54	Analog Bs 2
I15	SA Rhodes !!	I55	THE STRINGS
I16	Pan Pipe	I56	Hammer Bell
I17	Slap !!!	I57	Fine Organ
I18	Doowah Diddy	I58	Stackoid
I21	A.Piano 3	I61	Huff N Stuff
I22	Turbo Sax	I62	Autumn Breez
I23	Orch Stab 2	I63	Toy Box
I24	Analog Pad 1	I64	Analog Horn
I25	Great Church	I65	Orch Stab 3
I26	Rubber Bs 3	I66	Reincarnate
I27	Analog Brass	I67	Wave Bells 2
I28	X/Y/Z	I68	Whistle Lead
I31	Lumber Jacow	I71	UTAKATA
I32	Nylon Gtr 2	I72	Analog Pad 2
I33	YASURAGI	I73	Dist Line
I34	House Hunter	I74	Super Vibe
I35	Mighty Pad	I75	Stratusphere
I36	SAW Lead	I76	Voiccy PiZZ
I37	Ice Hall	I77	Black Brass
I38	Organarimba	I78	Glass Pad
I41	Spr Trumpet	I81	Reso Pad
I42	Mix On Mute	I82	Hardy Winery
I43	P - P - P - Puff	I83	Steel Pizz
I44	Fantasia JV	I84	WhistlinAtom
I45	Glasswaves	I85	ChuChu Vox
I46	El.Piano	I86	Arctic Winds
I47	Jazz Organ 3	I87	DistanceCall
I48	5 - Strng Bass	I88	REVERCE MAD

■ Preset A

● Performance

No	Name
A01	Jazz Split
A02	Softly.....
A03	Bossa nova
A04	Jazzygroove
A05	OLD Bar
A06	FUNKY
A07	Pop Fusion
A08	Fusion Set
A09	Heavy
A10	Rokin Split
A11	Brass Rock
A12	Hard Wire
A13	Perc Harmnix
A14	Classy Piano
A15	Perc Strings
A16	PopOrchestra

● Patch

No	Name	No	Name
A11	A.Piano 1	A51	Nylon Gtr 1
A12	A.Piano 2	A52	Flanged Nyln
A13	Mellow Piano	A53	Steel Guitar
A14	Pop Piano 1	A54	PickedGuitar
A15	Pop Piano 2	A55	12 strings
A16	Pop Piano 3	A56	Velo Harmnix
A17	MIDled Grand	A57	Nylon+Steel
A18	Country Bar	A58	SwitchOnMute
A21	Glist El Pno	A61	JC Strat
A22	MIDI EPiano	A62	Stratus
A23	SA Rhodes	A63	Syn Strat
A24	Dig Rhodes 1	A64	Pop Strat
A25	Dig Rhodes 2	A65	Clean Strat
A26	Stiky Rhodes	A66	Funk Gtr
A27	Guitr Rhodes	A67	Syn Guitar
A28	Nylon Rhodes	A68	Overdrive
A31	Clav 1	A71	Fretless
A32	Clav 2	A72	St Fretless
A33	Marimba	A73	Woody Bass 1
A34	Marimba SW	A74	Woody Bass 2
A35	Warm Vibe	A75	Analog Bs 1
A36	Vibe	A76	House Bass
A37	Wave Bells	A77	Hip Bass
A38	Vibrobell	A78	RockOut Bass
A41	Pipe Organ 1	A81	Slap Bass
A42	Pipe Organ 2	A82	Thumpin Bass
A43	Pipe Organ 3	A83	Pick Bass
A44	E.Organ 1	A84	Wonder Bass
A45	E.Organ 2	A85	Yowza Bass
A46	Jazz Organ 1	A86	Rubber Bs 1
A47	Jazz Organ 2	A87	Rubber Bs 2
A48	Metal Organ	A88	Stereoww Bs

■ Preset B

● Performance

No	Name
B01	GTR Players
B02	Synth Plus
B03	PianoEnembi
B04	Church Choir
B05	YMBA Choir
B06	THE MALLETS
B07	South Shore
B08	Guitar Club
B09	for CompuMix
B10	Introduction
B11	House Sounds
B12	Cosmo Space
B13	Acoustics
B14	Finale!!
B15	Perseverance
B16	NewListening

● Patch

No	Name	No	Name
B11	Pizzicato	B51	Brass Combo
B12	Real Pizz	B52	Stab Brass
B13	Harp	B53	Soft Brass
B14	SoarinString	B54	Horn Brass
B15	Warm Strings	B55	French Horn
B16	Marcato	B56	AltoLead Sax
B17	St Strings	B57	Alto Sax
B18	Orch Strings	B58	Tenor Sax 1
B21	Slow Strings	B61	Tenor Sax 2
B22	Velo Strings	B62	Sax Section
B23	BrightStrngs	B63	Sax Tp Tb
B24	TremoloStrng	B64	FlutePiccolo
B25	Orch Stab 1	B65	Flute mod
B26	Brite Stab	B66	Ocarina
B27	JP – 8 Strings	B67	OverblownPan
B28	String Synth	B68	Air Lead
B31	Wire Strings	B71	Steel Drum
B32	New Age Vox	B72	Log Drum
B33	Arasian Morn	B73	Box Lead
B34	Beauty Vox	B74	Soft Lead
B35	Vento Voxx	B75	Whistle
B36	Pvox Oooze	B76	Square Lead
B37	GlassVoices	B77	Touch Lead
B38	Space Ahh	B78	NightShade
B41	Trumpet	B81	Pizza Hutt
B42	Trombone	B82	EP+Exp Pad
B43	Harmon Mute1	B83	JP – 8 Pad
B44	Harmon Mute2	B84	Puff
B45	TeaJay Brass	B85	SpaciosSweep
B46	Brass Sect 1	B86	Big n Beefy
B47	Brass Sect 2	B87	RevCymBend
B48	Brass Swell	B88	Analog Seq

Rhythm Set

		Internal		Preset A		Preset B	
		Tone Name	Wave No.	Tone Name	Wave No.	Tone Name	Wave No.
C2	36	Bright Kick	80	Bright Kick	80	Bright Kick	990
	37	Cross Stick 1	102	Cross Stick 1	102	Cross Stick 1	102
	38	90's Snare	95	90's Snare	85	Piccolo SN	88
	39	808 Claps	103	808 Claps	103	808 Claps	103
	40	LA Snare	97	90's Snare	85	LA Snare	87
	41	Power Tom Lo	101	Power Tom Lo	101	Power Tom Lo	101
	42	Closed HAT 1	94	Closed HAT 1	94	Closed HAT 1	94
	43	Power Tom Lo	101	Power Tom Lo	101	Power Tom Lo	101
	44	Closed HAT 2	95	Closed HAT 2	95	Closed HAT 2	95
	45	Power Tom Hi	100	Power Tom Hi	100	Power Tom Lo	101
	46	Open HAT 1	98	Open HAT 1	98	Open HAT 1	96
	47	Power Tom Hi	100	Power Tom Hi	100	Power Tom Lo	101
C3	48	Power Tom Hi	100	Power Tom Hi	100	Power Tom Hi	100
	49	Crash 1	97	Crash 1	97	Crash 1	97
	50	Power Tom Hi	100	Power Tom Hi	100	Power Tom Hi	100
	51	Ride 1	98	Ride 1	98	Ride 1	98
	52	Ride Bell	99	Tin Wave	82	Crash 1	97
	53	REV SN 1	119	Ride Bell 1	99	Ride Bell 1	99
	54	Tambourine	105	Tambourine	105	Crash 1	97
	55	REV SN 2	119	Spectrum 1	83	Crash 1	97
	56	Cowbell 1	104	Cowbell 1	104	Cowbell 1	104
	57	REV SN 3	120	Crash 1	97	Crash 1	97
	58	Cowbell 1	104	Crash 1	97	Cowbell 1	104
	59	REV SN 4	121	Piccolo SN	98	Crash 1	97
C4	60	CGA Mute Hi	107	CGA Mute Hi	107	CGA Mute Hi	107
	61	CGA Mute Lo	108	CGA Mute Lo	108	Conga Hi	110
	62	CGA Slap	109	CGA Slap	109	CGA Slap	109
	63	Conga Hi	110	Conga Hi	110	Conga Lo	111
	64	Conga Lo	111	Conga Lo	111	CGA Mute Lo	109
	65	Timbale	108	Timbale	108	Timbale	108
	66	Timbale	106	Timbale	106	Timbale	106
	67	Agogo	53	Power Tom Lo	101	Timbale	106
	68	Agogo	53	LA Snare	87	Timbale	106
	69	Cabasa Up	114	Cabasa Up	114	Agogo	53
	70	Maracas	112	Maracas	112	Agogo	53
C5	71	Cabasa Down	115	Cabasa Down	115	Cabasa Up	114
	72	Maracas Cut	113	Maracas Cut	113	Cabasa Down	115
	73	808 Kick	93	Whack Snare	88	Maracas	112
	74	808 SNR 1	84	Verb Kick	91	Maracas Cut	113
	75	DIGI Bell 1	58	Rim Shot	89	Tambourine	105
	76	808 SNR 1	84	Round Kick	92	Log Drum	57
	77	808 Kick	93	808 Kick	93	DIGI Bell 1	58
	78	Spectrum 1	83	Cabasa Down	115	DIGI Chime	59
	79	808 Kick	93	REV Steel DR	116	Steel Drums	60
	80	Spectrum 1	83	REV Tin Wave	117	Anklungs	79
	81	808 Kick	93	REV SN 1	119	Wind Chimes	80
	82	Spectrum 1	83	REV SN 2	119	Rattles	91
C6	83	808 Kick	93	REV SN 3	120	Ronund Kick	92
	84	808 Kick	93	Wind Chimes	80	808 Kick	93
	85	Feedbackwave	78	REV Kick	122	808 Kick	93
	86	808 Kick	93	Anklungs	79	808 SNR 1	84
	87	Feedbackwave	78	Rattles	81	REV TAMB	126
	88	Pop Voice	48	REV Cow Bell	125	90's Snare	85
	89	Pop Voice	48	REV TAMB	126	Closed HAT 1	94
	90	Wind Agogo	76	REV Conga	127	Tin Wave	82
	91	Pop Voice	48	REV Maracas	128	Spectrum 1	83
	92	Wind Agogo	76	REV Crash	129	REV Steel DR	116
	93	Open HAT 1	96	Steel Drum	60	REV Tin Wave	117
	94	Anklungs	79	Wind Agogo	78	REV SN 1	118
C7	95	Open HAT 1	96	Wind Agogo	78	REV Crash 1	129
	96	Open HAT 1	96	808 SNR 1	84	REV Cow Bell	125

6. Blank Chart

[Performance]

Performance Number		Performance Name	
--------------------	--	------------------	--

COMMON	
Key Mode	

EFFECT			
CHORUS		REVERB	
Type		Type	
Level		Level	
Rate		Time	
Depth		Feedback	
Feedback			
Output			

TRANSMIT ZONE								
	Part 1	Part 2	Part 3	Part 4	Part 5	Part 6	Part 7	Part 8 (R)
Key Range Lower								
Key Range Upper								
Transpose								
Max Velocity								
Velocity Sense								
Velocity Curve								
Transmit Channel								
Program Change								
Transmit Volume								
Transmit Pan								
Transmit Switch								

INTERNAL ZONE								
	Part 1	Part 2	Part 3	Part 4	Part 5	Part 6	Part 7	Part 8 (R)
Key Range Lower								
Key Range Upper								
Transpose								
Max Velocity								
Velocity Sense								
Velocity Curve								
Local Switch								

PART								
	Part 1	Part 2	Part 3	Part 4	Part 5	Part 6	Part 7	Part 8 (R)
Patch Select								
Part Level								
Part Pan								
Coarse Tune								
Fine Tune								
Receive Channel								
Voice Reserve								
Chorus Switch								
Reverb Switch								
Receive Program Change								
Receive Volume								
Receive Hold --1								
Receive Switch								

[Rhythm Tone]

Assign Key	
------------	--

EFFECT							
Dry Level							
Chorus Send Level				Reverb Send Level			
CONTROL							
Bend Range				Env Mode			
Mute Group							
WAVE/LFO							
Tone Switch							
Wave Group				Wave number			
PITCH							
Pitch Coarse				Pitch Envelope Depth			
Pitch Shift Fine				Velocity Level Sense			
Random Pitch Depth				Velocity Time Sense			
Pitch Envelope	T1		T2		T3		T4
	L1		L2		L3		L4
TVF							
Filter Type				TVF Envelope Depth			
Cutoff				Velocity Level Sense			
Resonance				Velocity Time Sense			
Resonance Mode							
TVF Envelope	T1		T2		T3		T4
	L1		L2		L3		L4
TVA							
Tone Level				Velocity Time Sense			
Velocity Level Sense				Panning Offset			
TVA Envelope	T1		T2		T3		T4
	L1		L2		L3		L4

[Patch]

Patch Number		Patch Name	
---------------------	--	-------------------	--

COMMON										
Patch Level		Patch Pan		Velocity Range SW						
Velocity Range Lower - Upper		Tone 1		Tone 2		Tone 3		Tone 4		
		-		-		-		-		
EFFECT										
		Tone 1		Tone 2		Tone 3		Tone 4		
Dry Level										
Chorus Send level										
Reverb Send level										
Chorus	Type					Reverb	Type			
	Level						Level			
	Rate						Time			
	Depth						Feedback			
	Feedback						Analog Feel Depth			
	Output									
CONTROL										
Key Assign						Portamento Switch				
Legato						Portamento Mode				
Bend Range Down						Portamento Type				
Bend Range Up						Portamento Time				
		Tone 1		Tone 2		Tone 3		Tone 4		
Volume Control SW										
HOLD - 1 Control SW										
Modulation	Dest									
	Depth									
Aftertouch	Dest									
	Depth									
Expression	Dest									
	Depth									
WAVE/LFO										
		Tone 1		Tone 2		Tone 3		Tone 4		
Tone Switch										
Wave Group										
Wave Number (Name)										
FXM Switch										
FXM Depth										
LFO 1	Waveform									
	Syncro Switch									
	Rate									
	Wave Offset									
	Delay Time									
	Fade Mode									
LFO 2	Waveform									
	Syncro Switch									
	Rate									
	Wave Offset									
	Delay Time									
	Fade Mode									
LFO Depth		PIT1	PIT2	PIT1	PIT2	PIT1	PIT2	PIT1	PIT2	
		TVF1	TVF2	TVF1	TVF2	TVF1	TVF2	TVF1	TVF2	
		TVA1	TVA2	TVA1	TVA2	TVA1	TVA2	TVA1	TVA2	

PITCH												
	Tone 1			Tone 2			Tone 3			Tone 4		
Coarse Tune												
Fine Tune												
Random Pitch Depth												
Pitch Key Follow												
Pitch Envelope Depth												
Velocity Level Sense												
Velo Sense - T1												
Velo sense - T4												
Time Key Follow												
Pitch Envelope	T1	L1		T1	L1		T1	L1		T1	L1	
	T2	L2		T2	L2		T2	L2		T2	L2	
	T3	L3		T3	L3		T3	L3		T3	L3	
	T4	L4		T4	L4		T4	L4		T4	L4	
TVF												
	Tone 1			Tone 2			Tone 3			Tone 4		
Filter Type												
Cutoff												
Reonance												
Reonance Mode												
Cutoff Key Follow												
TVF Envlope Depth												
Velocity Curve Type												
Velo Env Level Sense												
Velo - T1												
Velo - T4												
Time Key Follow												
TVF Envelope	T1	L1		T1	L1		T1	L1		T1	L1	
	T2	L2		T2	L2		T2	L2		T2	L2	
	T3	L3		T3	L3		T3	L3		T3	L3	
	T4	L4		T4	L4		T4	L4		T4	L4	
TVA												
	Tone 1			Tone 2			Tone 3			Tone 4		
Tone Level												
Level Key Follow												
Velocity Curve Type												
Velocity Level Sense												
Panning												
Panning Key Follow												
Tone Delay Mode												
Tone Delay Time												
Velo Sense - T1												
Velo Sense - T4												
Time Key Follow												
TVA Envelope	T1	L1		T1	L1		T1	L1		T1	L1	
	T2	L2		T2	L2		T2	L2		T2	L2	
	T3	L3		T3	L3		T3	L3		T3	L3	
	T4	L4		T4	L4		T4	L4		T4	L4	

[System Common]

TUNE/FUNCTION						
Master Tune		Key Transpose		LCD Contrast		
CONTROL ASSIGN						
	Output	Assign	Polarity			
Pedal 1						
pedal 2						
C1 Slider						
Hold						
Aftertouch Threshold						
MIDI						
	Local Sw	Ctrl Ch	Tx Ch		Transmit	Receive
Patch				Program Change		
Performance				Bank Select		
	Receive Switch	Unit Number		Control Change		
System Exclusive				Volume		
				Bender		
				Modulation		
				Aftertouch		

7. Operation Examples of the JV-80

This section provides specific operating examples that take you step-by-step in using some of the functions of the JV-80.

■ Using the JV-80 in Live Performance

The JV-80 has many realtime performance functions that let you change the sounds as you play, letting you respond instantly and effectively to the changes and conditions that occur in a live performance.

[1] *When playing in the Patch Play mode (P.30), Patches which are themselves sound programs can be finely adjusted. Parameters that especially lend themselves to being changed in this way are level, cutoff, resonance and the attack time of the envelope.*

Reference Patch → I73 Dist Line

[1] Press **CUTOFF** in the Patch Play mode and select the page for changing the cutoff frequency of the Tone.

PATCH	↑Dist Line	:		Cutoff
I73	↓ 1271	1271	1271	127

The set values for the TVF cutoff of Tones 1 — 4 are indicated from left to right in the LCD.

[2] The brightness of sound of each Tone can be adjusted. Check that the cutoff values of the corresponding Tones change by moving Parameter Sliders 1 — 4 and that the timbre of the sound itself changes as well.

Even without being changed, this Patch itself has a particularly brilliant sound. Tones 2 and 3 are especially important in determining the characteristics of this sound program. Use the appropriate Parameter Sliders to adjust the cutoff of Tones 2 and 3 and notice how the brightness of the sound continually changes.

※ We suggest that you turn off the sounds of Tones 1 and 4 with by the Tone switches so that you more easily hear the change in the sound.

Even though the brightness (frequency elements) of the sound remains the same, the character of the sound can be altered by adjusting how the sound starts.

[3] Press **ATTACK** and select the page for changing the attack time (T1) of the TVA envelope.

Adjust the attack time of each Tone as you play by using Parameter Slider 1 and notice how the attack sound changes.

[4] Try using these techniques on other parameters and explore the wide range of realtime sound adjustments available.

※ Press **BANK** / **NUMBER** again to select the same numbered program and restore the original Patch. Write the data to memory from the Write mode (P.154) when you wish to store the Patch as you've changed it.

[2] *The Performance Play mode lets you use the JV-80 as a sophisticated master MIDI keyboard, allowing you a great deal of expressive and functional MIDI control.*

Reference Performance → I16 TUTORIAL

Play chords with your left hand for the strings sound program and play the melody with your right hand for the piano sound program. Parts 1 and 2 out of the eight Parts are used in this example for explanation purposes.

※ The local switch (P.66) of Parts 3 — 8 of this Performance should be set to OFF so that they do not sound.

The strings sound is assigned to Part 1 of this Performance, and the piano is assigned to Part 2.

The sound range of each program can be limited by setting the key range (P.67) for the Part.

- [1] Press **INT TRANS** and select the Int. Range Lower and Int. Range Upper pages by using **▼**.

```
PERFORM #TUTORIAL : Int. Range Lower
I16 #C2 IC2 IC2 IC2 IC2 IC2 IC2 IC2 IC2
```

```
PERFORM #TUTORIAL : Int. Range Upper
I16 #C7 IC7 IC7 IC7 IC7 IC7 IC7 IC7 IC7
```

- [2] Adjust the key range with Parameter Sliders 1 and 2. For example, if you set the key range of Part 1 to C2 — B3, and the key range of Part 2 to C4 — C7, the Parts can be played separately with the C4 key as the split point. By setting the key range of both Parts to C2 — C7, the two sounds can be layered.

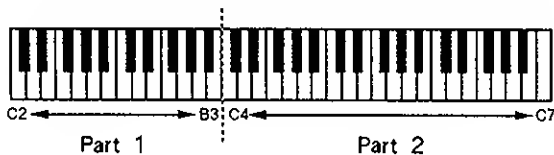

You can adjust the relative volume balance of Parts 1 and 2 by first pressing the **LEVEL** button then adjusting the levels of the individual Parts by using Parameter Sliders 1 and 2.

```
PERFORM #TUTORIAL : Part Level
I16 #127|127|127|127|127|127|127|127
```

You can also play ranges of the sound that would normally be outside the range of the keyboard by adjusting the transpose (P.66) setting of each Part.

- [3] Select the Int. Transpose page by pressing **INT TRANS**.

- [4] Adjust the internal transpose value with Parameter Sliders 1 and 2. A setting of 12 transposes the sound to one octave above normal, and a setting of - 12 transposes one octave lower.

```
PERFORM #TUTORIAL : Int. Transpose
I16 # 01 01 01 01 01 01 01 01 0
```

You can change the degree to which individual Parts respond to your playing strength by adjusting the parameters related to velocity (P.66). In this example, by keeping the level of the strings sound low, the dynamic range of the piano sound can be heard more easily.

- [5]** Press **INT TRANS** and select the Int.Velo Sense page by using **▲**.

Set the value for Part 1 to 10, and Part 2 to 32.

```
PERFORM #TUTORIAL      : Int.Velo Sense
I16      #+10|+32|+32|+32|+32|+32|+32|+32
```

Select the Int.V-Crv page and set Part 1 to curve 2 and Part 2 to curve 4.

```
PERFORM #TUTORIAL      : Int.V-Crv P2=2✓
I16      # 2| 4| 1| 1| 1| 1| 1| 1
```

Select the Int.Max Velocity page and set Part 1 to a value of 64 and Part 2 to 127.

```
PERFORM #TUTORIAL      : Int.Max Velocity
I16      # 64|127|127|127|127|127|127|127
```

The relative volume range of the two Parts and how they respond to velocity as determined by these parameters is shown in the graphs below. The range over which the Patch changes is narrow for Part 1 and wide for Part 2.

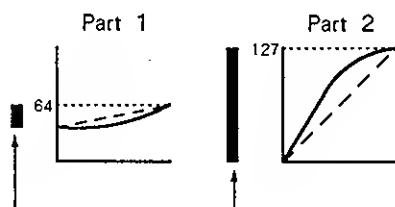

The range over which the sounding Part changes

By using the above operations on all eight Parts, setting each Part to respond differently depending on how and in which range you play the keyboard, you can achieve a variety of dynamic and textural changes as you play.

Multi Sound Source for Desktop Music and Home Studio Applications

Reference Performance → I16 TUTORIAL

[1] In this section, we'll use the JV-80 to play several channels of music data recorded to a MIDI sequencer.

※ Only Part 1 and Part 2 of this Performance are set to receive play data from the keyboard. Perform the following steps so that the other Parts can be played.

① Press **INT TRANS**.

② Press the **PART SWITCH** of the Part to be played, making sure that the indicator is lit.

Set the MIDI receiving channel of the Part. Parts 1 — 8 of this Performance are set to receive over MIDI channels 1, 2, 3, 4, 5, 6, 7, and 10, respectively, as a factory-set default. (See P.xx for more on setting the MIDI receive channels.)

[1] Press **LEVEL** and select the Receive Channel page by using **▼**.

```
PERFORM #TUTORIAL      :   Receive Channel
I16      #  1|  2|  3|  4|  5|  6|  7| 10|
```

[2] Select the receiving channel of the Part to be changed by using the appropriate Parameter Slider.

Select the Patch to be assigned to the Part.

[3] Select the Patch Select page by using **▲**.

```
PERFORM | Patch Select. P1=Orch Strings
I16      #B18|A11|A74|A44|A57|B13|B64|INT
```

[4] Change the Patch numbers by using the Parameter Sliders. You can also move the cursor with the **◀**/**▶** buttons to the Patch you wish to change, then input the number of the Patch directly by selecting, in order: **USER/PRESET** / **INT/CARD A/B** / **BANK** / **NUMBER**.

Set the receive switch to ON so that only the specified Part will receive MIDI data.

[5] Press the appropriate **PART SWITCH** buttons to select the Parts to receive MIDI data. The indicators of the selected Part Switches should be lit.

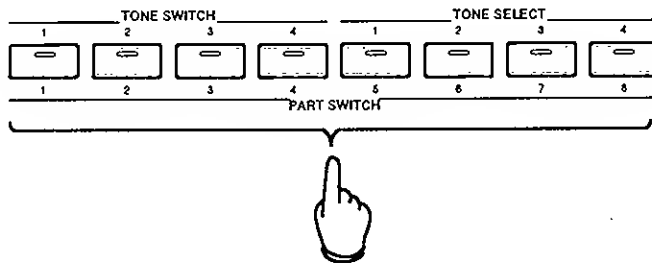

Adjust the level and stereo position (P.59) like you would on a conventional mixer while listening to playback of the Parts. All Parts of this Patch have been given level settings of 100 and pan settings of 0 (center) at the factory.

- 【6】** Select the Part Level page by pressing **▲** or **▼**.

```
PERFORM #TUTORIAL : Part Level
I16 #100|100|100|100|100|100|100|100
```

- 【7】** Adjust the levels of the Parts with the Parameter Sliders.

- 【8】** Press **PAN** to select the Part Pan page.

```
PERFORM #TUTORIAL : Part Pan
I16 # 0 | 0 | 0 | 0 | 0 | 0 | 0 | 0
```

- 【9】** Adjust the pan settings of the Parts with the Parameter Sliders.

[2] Next, we'll record play data including volume and pan data to the MIDI sequencer.

Let's record the play data over several MIDI channels.

※ Assuming that you will start recording from the operations you just performed in [1] above (setting the level and the pan of each Part), call up this Performance by using **[BANK]** / **[NUMBER]** and return to the previous condition of the Part.

For this Performance, the MIDI send and receive channels (P.60, 63) are matched so that recorded data can be reproduced by the same Part. Follow the steps given below when setting the MIDI send and receive channels manually.

[1] Press **[TX VOLUME]** and select the Transmit channel by using **[▼]**.

```

PERFORM #TUTORIAL      : Transmit Channel
I16      #  1|  2|  3|  4|  5|  6|  7| 10
    
```

[2] Set the transmission channel of each Part by using the corresponding Parameter Slider.

[3] Press **[LEVEL]** and select the Receive Channel page by using **[▼]**.

```

PERFORM #TUTORIAL      : Receive Channel
I16      #  1|  2|  3|  4|  5|  6|  7| 10
    
```

[4] Set the receiving channel of each Part by using the corresponding Parameter Slider.

You can also have the transmission and receiving channels automatically matched by making the following settings.

[1] Go to the Performance Edit mode by pressing **[PERFORMANCE EDIT]**.

[2] Press **[COMMON]** to select the KEY MODE page by using **[▼]**.

```

KEY MODE  #  Mode |-----|-----|-----|
           #  ZONE |-----|-----|-----|
    
```

[3] Set the Mode to SINGLE with Parameter Slider 1.

```

KEY MODE  #  Mode |-----|-----|-----|
           #  SINGLE|-----|-----|-----|
    
```

[4] Go to the Performance play mode by pressing **[PERFORMANCE PLAY]**.

※ In this setting, MIDI transmission and reception is possible only for the Part at the cursor position. This is convenient for inputting data for each Part.

Let's set the JV-80 so that only the Part to be recorded can be transmitted over MIDI.

【Operation】 Press **TX VOLUME**. Press the **PART SWITCH** button corresponding to the channel of the Part to be transmitted and make sure that only this button's indicator is lit.

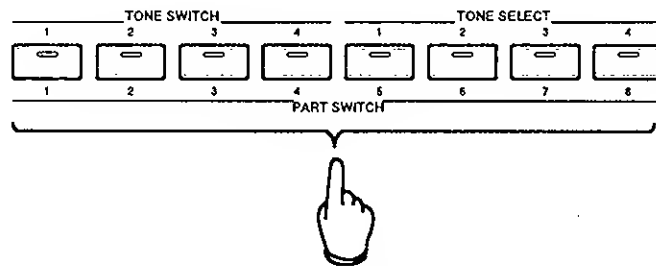

Adjust the velocity related parameters (P.63, 64) in the transmit zone as desired to change how the Part responds to key velocity.

- 【1】** Press **TX TRANS**.
- 【2】** Select the velocity related page by using **▲**.
- 【3】** Adjust the parameters with the Parameter Sliders.

Record to the sequencer.

※ "Soft thru" is a special MIDI operation in which the JV-80 and sequencer are connected by both their MIDI IN and MIDI OUT terminals, and the play data received by the sequencer is re-transmitted via MIDI OUT. In order to prevent the same play data being sent from the keyboard and MIDI to the Part, and keep the Part from receiving play data from the keyboard, set the local switch of the Part to OFF with the following operation.

- 【1】** Press **INT TRANS**.
- 【2】** Turn off the appropriate **PART SWITCH**, making sure that the indicator light is off.

Merge the volume and pan data together onto the recorded play data. You can use the Parameter Sliders to easily enter such data as for fading the song in and out and moving sounds in the stereo sound image.

- 【1】** Press **TX VOLUME** when inputting volume data, and press **TX PAN** when inputting pan data.
- 【2】** Turn on the MIDI transmit/receive switch of the channel which contains the data to be merged, and play the data back again.

【3】 Record the volume and pan data to another track of the sequencer by adjusting the Parameter Slider which corresponds to the transmit zone to be transmitted. Data can be input while monitoring the effect, if the sequencer is capable of soft through operation.

【4】 Simultaneously play back the tracks to which the play data, volume and pan data were recorded. Listen to the result merge them by using the edit function of the sequencer, if you are satisfied with the mix.

※ When adjusting volume and pan settings while listening to the data being played back, we suggest that you leave the Part volume to the certain value and set the pan to center, since if the Part level and Part pan of the JV-80 are adjusted, the effects of those adjustments are added and sounded.

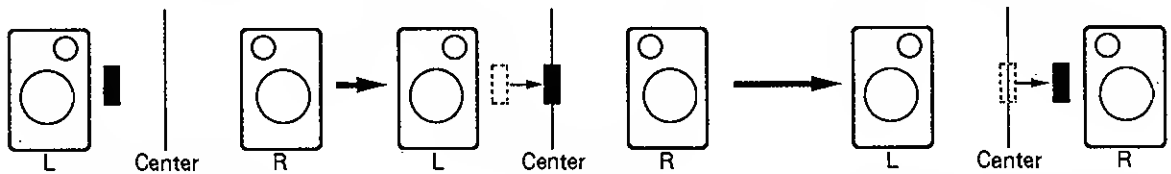

Create song data in which MIDI messages move the stereo position of the Part to the center

The stereo position moves to one side if this song data is played back for a Part whose stereo position is already set to the center.

※ Keep in mind that when volume data and pan data have already been entered to the original play data, new data transmitted from the JV-80 is recorded over them. This means that when you play back the data again, the newly recorded volume and pan data, as well as the original volume and pan data, are transmitted to the JV-80. This also greatly increases the amount of play data. We suggest that you try to merge with play data which does not already include volume and pan data.

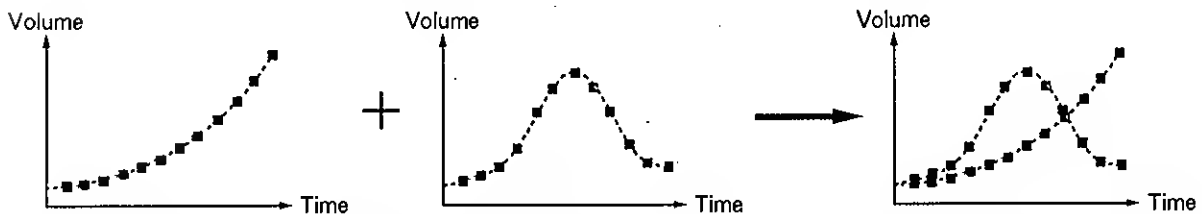

The volume data transmitted from the JV-80 is added to the song data to which volume data has been recorded.

The result is superfluous and conflicting volume data.

In addition to the above, the potential applications are expanded by use of the foot pedal, C1 slider (P.73), and TRANSMIT/RECEIVE MIDI switch (P.76).

Roland Exclusive Messages

1. Data Format for Exclusive Messages

Roland's MIDI implementation uses the following data format for all exclusive messages (type IV):

Byte	Description
F0H	Exclusive status
41H	Manufacturer ID (Roland)
DEV	Device ID
MDL	Model ID
CMD	Command ID
[BODY]	Main data
F7H	End of exclusive

MIDI status : F0H, F7H

An exclusive message must be flanked by a pair of status codes, starting with a Manufacturer-ID immediately after F0H (MIDI version 1.0).

Manufacturer-ID : 41H

The Manufacturer-ID identifies the manufacturer of a MIDI instrument that triggers an exclusive message. Value 41H represents Roland's Manufacturer ID.

Device-ID : DEV

The Device-ID contains a unique value that identifies the individual device in the multiple implementation of MIDI instruments. It is usually set to 0011 0F11, a value smaller by one than that of a basic channel, but value 0011 1F1H may be used for a device with multiple basic channels.

Model-ID : MDL

The Model-ID contains a value that uniquely identifies one model from another. Different models, however, may share an identical Model-ID if they handle similar data.

The Model-ID format may contain 00H in one or more places to provide an extended data field. The following are examples of valid Model-IDs, each representing a unique model:

01H
02H
03H
00H, 01H
00H, 02H
00H, 00H, 01H

Command-ID : CMD

The Command-ID indicates the function of an exclusive message. The Command-ID format may contain 00H in one or more places to provide an extended data field. The following are examples of valid Command-IDs, each representing a unique function:

01H
02H
03H
00H, 01H
00H, 02H
00H, 00H, 01H

Main data : BODY

This field contains a message to be exchanged across an interface. The exact data size and contents will vary with the Model-ID and Command-ID.

2. Address-mapped Data Transfer

Address mapping is a technique for transferring messages conforming to the data format given in Section 1. It assigns a series of memory-resident records waveform and tone data, switch status, and parameters, for example to specific locations in a machine-dependent address space, thereby allowing access to data residing at the address a message specifies.

Address-mapped data transfer is therefore independent of models and data categories. This technique allows use of two different transfer procedures: one-way transfer and handshake transfer.

One-way transfer procedure (See Section 3 for details.)

This procedure is suited for the transfer of a small amount of data. It sends out an exclusive message completely independent of a receiving device status.

Connection Diagram

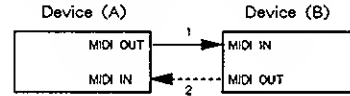

Connection at point 2 is essential for "Request data" procedures. (See Section 3.)

Handshake-transfer procedure (This device does not cover this procedure)

This procedure initiates a predetermined transfer sequence (handshaking) across the interface before data transfer takes place. Handshaking ensures that reliability and transfer speed are high enough to handle a large amount of data.

Connection Diagram

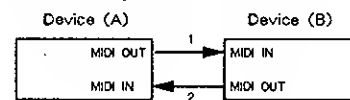

Connection at points 1 and 2 is essential.

Notes on the above two procedures

- * There are separate Command-IDs for different transfer procedures.
- * Devices A and B cannot exchange data unless they use the same transfer procedure, share identical Device-ID and Model ID, and are ready for communication.

3. One-way Transfer Procedure

This procedure sends out data all the way until it stops and is used when the messages are so short that answerbacks need not be checked. For long messages, however, the receiving device must acquire each message in time with the transfer sequence, which inserts intervals of at least 20 milliseconds in between.

Types of Messages

Message	Command ID
Request data 1	RQ1 (11H)
Data set 1	DT1 (12H)

Request data # 1 : RQ1 (11H)

This message is sent out when there is a need to acquire data from a device at the other end of the interface. It contains data for the address and size that specify designation and length, respectively, of data required.

On receiving an RQ1 message, the remote device checks its memory for the data address and size that satisfy the request. If it finds them and is ready for communication, the device will transmit a "Data set 1 (DT1)" message, which contains the requested data. Otherwise, the device will send out nothing.

Byte	Description
F0H	Exclusive status
41H	Manufacturer ID (Roland)
DEV	Device ID
MDL	Model ID
11H	Command ID
aaH	Address MSB
⋮	⋮
	LSB
ssH	Size MSB
⋮	⋮
	LSB
sum	Check sum
F7H	End of exclusive

Roland Exclusive Messages

- * The size of the requested data does not indicate the number of bytes that will make up a DT1 message, but represents the address fields where the requested data resides.
- * Some models are subject to limitations in data format used for a single transaction. Requested data, for example, may have a limit in length or must be divided into predetermined address fields before it is exchanged across the interface.
- * The same number of bytes comprises address and size data, which, however, vary with the Model-ID.
- * The error checking process uses a checksum that provides a bit pattern where the least significant 7 bits are zero when values for an address, size, and that checksum are summed.

Data set 1 : DT1 (12H)

This message corresponds to the actual data transfer process. Because every byte in the data is assigned a unique address, a DT1 message can convey the starting address of one or more data as well as a series of data formatted in an address-dependent order.

The MIDI standards inhibit non-real time messages from interrupting an exclusive one. This fact is inconvenient for the devices that support a "soft-through" mechanism. To maintain compatibility with such devices, Roland has limited the DT1 to 256 bytes so that an excessively long message is sent out in separate segments.

Byte	Description
F0H	Exclusiva
41H	Manufacturer ID (Roland)
DEV	Device ID
MDL	Model ID
12H	Command ID
aaH	Address MSB
⋮	⋮
⋮	⋮
ddH	Data
⋮	⋮
⋮	⋮
sum	Check sum
F7H	End of exclusiva

- * A DT1 message is capable of providing only the valid data among those specified by an RQ1 message.
- * Some models are subject to limitations in data format used for a single transaction. Requested data, for example, may have a limit in length or must be divided into predetermined address fields before it is exchanged across the interface.
- * The number of bytes comprising address data varies from one Model-ID to another.
- * The error checking process uses a checksum that provides a bit pattern where the least significant 7 bits are zero when values for an address, size, and that checksum are summed.

Example of Message Transactions

- Device A sending data to Device B
Transfer of a DT1 message is all that takes place.

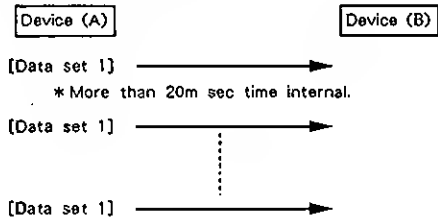

- Device B requesting data from Device A
Device B sends an RQ1 message to Device A. Checking the message, Device A sends a DT1 message back to Device B.

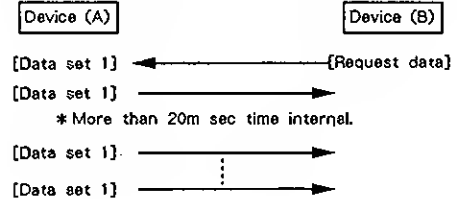

1. RECEIVE DATA

■ Channel Voice Message

● Note off

Status	Second	Third
8nH	kkH	vvH
9nH	kkH	00H

n MIDI channel number : 0H - FH (0 - 15) 0 = ch.1 15 = ch.16
 kk Note number : 00H - 7FH (0 - 127)
 vv Velocity : 00H - 7FH (0 - 127)

* In "PERFORMANCE PLAY MODE" and "PERFORMANCE EDIT MODE", ignored when "RECEIVE SWITCH = OFF" at each part.
 * In rhythm part (part 8), ignored when "Env-Mode=NO-SUS" at each rhythm tone.

● Note on

Status	Second	Third
9nH	kkH	vvH

n MIDI channel number : 0H - FH (0 - 15) 0 = ch.1 15 = ch.16
 kk Note number : 00H - 7FH (0 - 127)
 vv Velocity : 01H - 7FH (1 - 127)

* In "PERFORMANCE PLAY MODE" and "PERFORMANCE EDIT MODE", ignored when "RECEIVE SWITCH = OFF" at each part.

● Control change

○ Bank select

Status	Second	Third
BnH	00H	vvH

n MIDI channel number : 0H - FH (0 - 15) 0 = ch.1 15 = ch.16
 vv Bank number : 50H, 51H (80, 81)

* Bank select is suspended until receiving program change.
 * The bank number of user's memory is 80. The bank number of preset memory is 81.
 * Recognized when "RECEIVE MIDI/Bnk = ON".
 * In "PERFORMANCE PLAY MODE" and "PERFORMANCE EDIT MODE", ignored when "RECEIVE SWITCH = OFF" at each part.
 * When received on receive channel at each part, changed patch at each part.
 * When received on control channel, changed performance.

○ Modulation

Status	Second	Third
BnH	01H	vvH

n MIDI channel number : 0H - FH (0 - 15) 0 = ch.1 15 = ch.16
 vv Modulation depth : 00H - 7FH (0 - 127)

* Recognized when "RECEIVE MIDI/Mod = ON".
 * In "PERFORMANCE PLAY MODE" and "PERFORMANCE EDIT MODE", ignored when "RECEIVE SWITCH = OFF" at each part.

○ Portamento time

Status	Second	Third
BnH	05H	vvH

n MIDI channel number : 0H - FH (0 - 15) 0 = ch.1 15 = ch.16
 vv Portamento time : 00H - 7FH (0 - 127)

* Recognized when "RECEIVE MIDI/C.C = ON".
 * In "PERFORMANCE PLAY MODE" and "PERFORMANCE EDIT MODE", ignored when "RECEIVE SWITCH = OFF" at each part.

○ Data entry

Status	Second	Third
BnH	06H	mmH
BnH	26H	lH

n = MIDI channel number : 0H - FH (0 - 15) 0 = ch.1 15 = ch.16
 mm,l = Value of the parameter specified with RPN.

* You can adjust the volume of specified channel (part).
 * Recognized when "RECEIVE MIDI/C.C = ON".
 * In "PERFORMANCE PLAY MODE" and "PERFORMANCE EDIT MODE", ignored when "RECEIVE SWITCH = OFF" at each part.

○ Volume

Status	Second	Third
BnH	07H	vvH

n = MIDI channel number : 0H - FH (0 - 15) 0 = ch.1 15 = ch.16
 vv = Volume : 00H - 7FH (0 - 127)

* You can adjust the volume of specified channel (part).
 * Recognized when "RECEIVE MIDI/Vol = ON".
 * Ignored when "PEDALS VOLUME = OFF" at each tone.
 * In "PERFORMANCE PLAY MODE" and "PERFORMANCE EDIT MODE", ignored when "RECEIVE SWITCH = OFF" at each part.

○ Panpot

Status	Second	Third
BnH	0AH	vvH

n = MIDI channel number : 0H - FH (0 - 15) 0 = ch.1 15 = ch.16
 vv = Panpot : 00H - 7FH (0 - 127)

* "0" represent left end, "127" represent right end.
 * Recognized when "RECEIVE MIDI/C.C = ON".
 * In "PERFORMANCE PLAY MODE" and "PERFORMANCE EDIT MODE", ignored when "RECEIVE SWITCH = OFF" at each part.

○ Expression

Status	Second	Third
BnH	0BH	vvH

n = MIDI channel number : 0H - FH (0 - 15) 0 = ch.1 15 = ch.16
 vv = Expression : 00H - 7FH (0 - 127)

* Recognized when "RECEIVE MIDI/C.C = ON".
 * In "PERFORMANCE PLAY MODE" and "PERFORMANCE EDIT MODE", ignored when "RECEIVE SWITCH = OFF" at each part.

○ Hold1

Status	Second	Third
BnH	40H	vvH

n = MIDI channel number : 0H - FH (0 - 15) 0 = ch.1 15 = ch.16
 vv = Control Value : 00H - 7FH (0 - 127) 0 - 63 = OFF 64 - 127 = ON

* Recognized when "RECEIVE MIDI/C.C = ON".
 * Ignored when "PEDALS HOLD - 1 = OFF" at each tone.
 * In "PERFORMANCE PLAY MODE" and "PERFORMANCE EDIT MODE", ignored when "RECEIVE SWITCH = OFF" at each part.
 * In rhythm part (part 8), ignored when "Env-Mode=NO-SUS" at each rhythm tone.

○ Portamento

Status	Second	Third
BnH	40H	vvH

n = MIDI channel number : 0H - FH (0 - 15) 0 = ch.1 15 = ch.16
 vv = Control Value : 00H - 7FH (0 - 127) 0 - 63 = OFF 64 - 127 = ON

* Recognized when "RECEIVE MIDI/C.C = ON".
 * In "PERFORMANCE PLAY MODE" and "PERFORMANCE EDIT MODE", ignored when "RECEIVE SWITCH = OFF" at each part.

○ Reverb

<u>Status</u>	<u>Second</u>	<u>Third</u>
BnH	5BH	vvH

n = MIDI channel number : 0H - FH (0 - 15) 0 = ch.1 15 = ch.16
 vv = Control Value : 00H - 7FH (0 - 127) 0 - 63 = OFF 64 - 127 = ON

* Recognized when "RECEIVE MIDI/C.C = ON".
 * In "PERFORMANCE PLAY MODE" and "PERFORMANCE EDIT MODE", ignored when "RECEIVE SWITCH = OFF" at each part.

○ Chorus

<u>Status</u>	<u>Second</u>	<u>Third</u>
BnH	5DH	vvH

n = MIDI channel number : 0H - FH (0 - 15) 0 = ch.1 15 = ch.16
 vv = Control Value : 00H - 7FH (0 - 127) 0 - 63 = OFF 64 - 127 = ON

* Recognized when "RECEIVE MIDI/C.C = ON".
 * In "PERFORMANCE PLAY MODE" and "PERFORMANCE EDIT MODE", ignored when "RECEIVE SWITCH = OFF" at each part.

○ RPN MSB/LSB

<u>Status</u>	<u>Second</u>	<u>Third</u>
BnH	65H	mmH
BnH	64H	llH

n = MIDI channel number : 0H - FH (0 - 15) 0 = ch.1 15 = ch.16
 mm = MSB of the specified parameter by RPN.
 ll = LSB of the specified parameter by RPN.

* In "PERFORMANCE PLAY MODE" and "PERFORMANCE EDIT MODE", ignored when "RECEIVE SWITCH = OFF" at each part.

** RPN **

RPN (Registered Parameter Number) is the expanded control change message. Each function of RPN is described by MIDI.

You can change the value of RPN parameters. First set RPN MSB/LSB before sending data entry.

JV - 80 can receive Pitch bend sensitivity (RPN #0), Master fine tuning (RPN #1), Master coarse tuning (RPN #2) and RPN reset (RPN #16383).

RPN	Data entry	Description
MSB LSB 00H 00H	mmH ---	Pitch bend sensitivity mm: 00H - 0CH (0 - 12 semitone) ll: Ignored (Up to 1 octave) * Changed "BENDER-RANGE LOWER" and "BENDER-RANGE UPPER" at the same. * In rhythm part (part 8), Ignored.
00H 01H	mmH llH	Master fine tuning mm, ll: 20H, 00H - 40H, 00H - 60H, 00H (-8192*50/8192 - 0 - +8192*50/8192 cent) * In "PATCH PLAY MODE" and "PATCH EDIT MODE", changed "MASTER TUNE". * In "PERFORMANCE PLAY MODE" and "PERFORMANCE EDIT MODE", changed "FINE TUNE" at each part. * When received on control channel, changed "MASTER TUNE".
00H 02H	mmH ---	Master coarse tuning mm: 10H - 40H - 70H (-48 - 0 - +48 semitone) ll: Ignored * In "PATCH PLAY MODE" and "PATCH EDIT MODE", Ignored. * In "PERFORMANCE PLAY MODE" and "PERFORMANCE EDIT MODE", changed "COARSE TUNE" at each part.
7FH 7FH	--- ---	RPN reset Return to no specified parameter of RPN. Current setting value is no change. mm, ll: Ignored

● Program change

<u>Status</u>	<u>Second</u>
CnH	ppH

n = MIDI channel number : 0H - FH (0 - 15) 0 = ch.1 15 = ch.16
 pp = Program number : 00H - 7FH (0 - 127)

* Recognized when "RECEIVE MIDI/P.C = ON".
 * In "PERFORMANCE PLAY MODE" and "PERFORMANCE EDIT MODE", ignored when "RECEIVE SWITCH = OFF" at each part.
 * When received on receive channel at each part, changed patch at each part.
 * When received on control channel, changed performance.

● Channel pressure

<u>Status</u>	<u>Second</u>
DnH	vvH

n = MIDI channel number : 0H - FH (0 - 15) 0 = ch.1 15 = ch.16
 vv = Value : 00H - 7FH (0 - 127)

* Recognized when "RECEIVE MIDI/Aft = ON".
 * In "PERFORMANCE PLAY MODE" and "PERFORMANCE EDIT MODE", ignored when "RECEIVE SWITCH = OFF" at each part.

● Pitch bend change

<u>Status</u>	<u>Second</u>	<u>Third</u>
EnH	llH	mmH

n = MIDI channel number : 0H - FH (0 - 15) 0 = ch.1 15 = ch.16
 mm, ll = Value : 00H, 00H - 7FH, 7FH (-8192 - +8191)

* Recognized when "RECEIVE MIDI/Bend = ON".
 * In "PERFORMANCE PLAY MODE" and "PERFORMANCE EDIT MODE", ignored when "RECEIVE SWITCH = OFF" at each part.

■ Channel Mode Message

● Reset all controllers

<u>Status</u>	<u>Second</u>	<u>Third</u>
BnH	79H	00H

n = MIDI channel number : 0H - FH (0 - 15) 0 = ch.1 15 = ch.16

* When "reset all controllers" is received, controller value of specified channel return to power on default.

Controller	Value
Modulation	0 (off)
Volume	127 (maximum)
Panpot	64 (center)
Expression	0 (off)
Hold1	0 (off)
Channel pressure	0 (off)
Pitch bend change	± 0 (center)
RPN	No specified parameter, value is no change.

● Local control

<u>Status</u>	<u>Second</u>	<u>Third</u>
BnH	7AH	vvH

n = MIDI channel number : 0H - FH (0 - 15) 0 = ch.1 15 = ch.16
 vv = Value : 00H, 7FH (0, 127) 0 = OFF 127 = ON

● All note off

<u>Status</u>	<u>Second</u>	<u>Third</u>
BnH	7BH	00H

n = MIDI channel number : 0H - FH (0 - 15) 0 = ch.1 15 = ch.16

* When "all note off" is received, turn off all MIDI-on notes.

● OMNI OFF

<u>Status</u>	<u>Second</u>	<u>Third</u>
BnH	7CH	00H

n = MIDI channel number : 0H - FH (0 - 15) 0 = ch.1 15 = ch.16

* OMNI OFF is only recognized as "all note off". Mode doesn't change.

● OMNI ON

Status	Second	Third
BnH	7DH	00H

n MIDI channel number : 0H - FH (0 - 15) 0 = ch.1 15 = ch.16

* OMNI ON is only recognized as "all note off". Mode doesn't change, still OMNI OFF.

● MONO

Status	Second	Third
BnH	7EH	mmH

n MIDI channel number : 0H - FH (0 - 15) 0 = ch.1 15 = ch.16
 mm Number of mono : 00H - 1FH (0 - 16)

* MONO is only recognized as "all note off". And the specified channel turns to Mode3 (m - 1).

● POLY

Status	Second	Third
BnH	7FH	00H

n MIDI channel number : 0H - FH (0 - 15) 0 = ch.1 15 = ch.16

* POLY is only recognized as "all note off". And the specified channel turns to Mode4.

● System Realtime Message

● Active sensing

Status
FEH

* When JV - 80 receive "active sensing", it measures time intervals between incoming messages. If the subsequent message will not come within 400 ms after previous one, JV - 80 turn off all MIDI - on notes as if it receives "reset all controllers", and stops measuring message interval.

■ System Exclusive Message

Status	Data
F0H	iiH, ddH,eeH
F7H	

F0H : System exclusive
 ii ID Number : 41H (65)
 dd,ee Data : 00H - 7FH (0 - 127)
 F7H : EOx (End of Exclusive/System common)

* Refer to section 3. 4.

2. TRANSMIT DATA

■ Channel Voice Data

● Note off

Status	Second	Third
8nH	kkH	vvH

n MIDI channel number : 0H - FH (0 - 15) 0 = ch.1 15 = ch.16
 kk Note number : 00H - 7FH (0 - 127)
 vv Velocity : 00H - 7FH (0 - 127)

* In "PERFORMANCE PLAY MODE" and "PERFORMANCE EDIT MODE", not transmit when "TRANSMIT SWITCH = OFF" at each part.

● Note on

Status	Second	Third
9nH	kkH	vvH

n MIDI channel number : 0H - FH (0 - 15) 0 = ch.1 15 = ch.16
 kk Note number : 00H - 7FH (0 - 127)
 vv Velocity : 01H - 7FH (1 - 127)

* In "PERFORMANCE PLAY MODE" and "PERFORMANCE EDIT MODE", not transmit when "TRANSMIT SWITCH = OFF" at each part.

● Control change

* The function of the Modulation lever is determined by control number 1 (modulation).
 * The function of the Hold pedal is determined by control number 64 (hold1).
 * Control numbers 0 - 95 can be assigned to Pedal1, Pedal2 and C1.

Status	Second	Third
BnH	ccH	vvH

n = MIDI channel number : 0H - FH (0 - 15) 0 = ch.1 15 = ch.16
 cc = Control number : 0H - 3FH, 46H - 5FH (0 - 63, 70 - 95)
 vv = Control value : 00H - 7FH (0 - 127)

Status	Second	Third
BnH	ccH	vvH

n = MIDI channel number : 0H - FH (0 - 15) 0 = ch.1 15 = ch.16
 cc = Control number : 40H - 45H (64 - 69)
 vv = Control value : 00H, 7FH (0, 127)

* Control change messages will be transmitted when the following parameter are set :

Control number	TRANSMIT MIDI
0, 32 (Bank Select)	Bnk = ON
1, 33 (Modulation)	Mod = ON
7, 39 (Volume)	Vol = ON
2 - 6, 8 - 31, 34 - 38, 40 - 95	C.C = ON

* In "PERFORMANCE PLAY MODE" and "PERFORMANCE EDIT MODE", not transmit when "TRANSMIT SWITCH = OFF" at each part.

● Program change

Status	Second
CnH	ppH

n = MIDI channel number : 0H - FH (0 - 15) 0 = ch.1 15 = ch.16
 pp = Program number : 00H - 7FH (0 - 127)

* Transmit when "TRANSMIT MIDI/P.C = ON".
 * In "PERFORMANCE PLAY MODE" and "PERFORMANCE EDIT MODE", not transmit when "TRANSMIT SWITCH = OFF" at each part.

● Channel pressure

Status	Second
DnH	vvH

n = MIDI channel number : 0H - FH (0 - 15) 0 = ch.1 15 = ch.16
 vv = Value : 00H - 7FH (0 - 127)

* Transmit when "TRANSMIT MIDI/Aft = ON".
 * In "PERFORMANCE PLAY MODE" and "PERFORMANCE EDIT MODE", not transmit when "TRANSMIT SWITCH = OFF" at each part.

● Pitch bend change

Status	Second	Third
EnH	lH	mmH

n = MIDI channel number : 0H - FH (0 - 15) 0 = ch.1 15 = ch.16
 mm, ll = Value : 00H, 00H - 7FH, 7FH (- 8192 - + 8191)

* Transmit when "TRANSMIT MIDI/Bend = ON".
 * In "PERFORMANCE PLAY MODE" and "PERFORMANCE EDIT MODE", not transmit when "TRANSMIT SWITCH = OFF" at each part.

■ System Real Time Message

● Active sensing

Status
FEH

* This message transmit at about 300 milli - seconds interval.

■ System Exclusive Message

Status	Data
F0H	iiH,ddH,....,eeH
F7H	
F0H	: System exclusive
ii -- ID number	: 41H (65)
dd,....,ee = Data	: 00H - 7FH (0 - 127)
F7H	: EOX (End of Exclusive/System common)

* Refer to section 3, 4.

3. EXCLUSIVE COMMUNICATIONS

JV - 80 can transmit and receive patch parameters, etc. using system exclusive message.

The model ID code of JV - 80 is 46H. The device ID code is to be determined by the unit number setting of MIDI function.

● One-way communication

● Request data RQ1 (11H)

Byte	Comments
F0H	Exclusive status
41H	Manufactures ID (Roland)
Dev	Device ID (Unit # - 1)
46H	Model ID (JV - 80)
11H	Command ID (RQ1)
aaH	Address MSB
bbH	Address
ccH	Address
ddH	Address LSB
ssH	Size MSB
ttH	Size
uuH	Size
vvH	Size LSB
sum	Check sum
F7H	EOX (End Of eXclusive)

● Data set DT1 (12H)

Byte	Comments
F0H	Exclusive status
41H	Manufactures ID (Roland)
Dev	Device ID (Unit # - 1)
46H	Model ID (JV - 80)
12H	Command ID (DT1)
aaH	Address MSB
bbH	Address
ccH	Address
ddH	Address LSB
eeH	Data
ffH	Data
sum	Check sum
F7H	EOX (End Of eXclusive)

4. PARAMETER ADDRESS MAP (Model ID = 46H)

Address and size are configured in 7 bits, and expressed in hexadecimal.

Address	MSB	LSB
Binary	0aaa aaaa	0bbb bbbb 0ccc cccc 0ddd dddd
7-bit hex	AA	BB CC DD
Size	MSB	LSB
Binary	0sss ssss	0ttt tttt 0uuu uuuu 0vvv vvvv
7-bit hex	SS	TT UU VV

■ Parameter base address

The Address having "*" is transmitted after its data is divided into two (upper 4 bits and lower 4 bits, upper first).

For example, 0ABh will be divided into 0Ah and 0Bh.

Start address	Description	
00 00 00 00	System Common	*1-1
00 00 10 00	Temporary Performance	*1-2
00 00 20 00	Performance Mode Temporary Patch (Part 1)	*1-3
00 01 20 00	Performance Mode Temporary Patch (Part 2)	
:	:	
00 06 20 00	Performance Mode Temporary Patch (Part 7)	
00 07 40 00	Temporary Rhythm Setup	*1-4
00 08 20 00	Patch Mode Temporary Patch	*1-3
:	:	
01 00 10 00	Internal Performance 101	*1-2
01 01 10 00	Internal Performance 102	
:	:	
01 0F 10 00	Internal Performance 116	
01 40 20 00	Internal Patch 111	*1-3
01 41 20 00	Internal Patch 112	
:	:	
01 7F 20 00	Internal Patch 188	
01 7F 40 00	Internal Rhythm Setup	*1-4
:	:	
02 00 10 00	Card Performance C01	*1-2
02 01 10 00	Card Performance C02	
:	:	
02 0F 10 00	Card Performance C16	
02 40 20 00	Card Patch C11	*1-3
02 41 20 00	Card Patch C12	
:	:	
02 7F 20 00	Card Patch C88	
02 7F 40 00	Card Rhythm Setup	*1-4

* 1 - 1 System Common

Offset address	Description	
00 0000 000a	Panel Mode	0 - 1 (PERFORMANCE_PATCH)
01 0aaa aaaa	Master Tune	1 - 127 (427.4 - 452.6)
02 0aaa aaaa	Key Transpose	28 - 100 (-36 - +36)
03 0000 000a	Transpose Switch	0 - 1 (OFF, ON)
04 0000 000a	Reverb Switch	0 - 1 (OFF, ON)
05 0000 000a	Chorus Switch	0 - 1 (OFF, ON)
06 0000 000a	Hold Polarity	0 - 1 (STANDARD, REVERSE)
07 0000 000a	Pedal 1 Polarity	0 - 1 (STANDARD, REVERSE)
08 0000 00aa	Pedal 1 Mode	0 - 3 (OFF, INT, MIDI, 1+M)
09 0aaa aaaa	Pedal 1 Assign	0 - 100 (CC0 - CC95, AFTERTOUCH, BEND-UP, BEND-DOWN, PROG-UP, PROG-DOWN)
0A 0000 000a	Pedal 2 Polarity	0 - 1 (STANDARD, REVERSE)
0B 0000 00aa	Pedal 2 Mode	0 - 3 (OFF, INT, MIDI, 1+M)
0C 0aaa aaaa	Pedal 2 Assign	0 - 100 (CC0 - CC95, AFTERTOUCH, BEND-UP, BEND-DOWN, PROG-UP, PROG-DOWN)

0D	0000 00aa	Cl Mode	0 - 3 (OFF, INT, MID1, I+M)
0E	0aaa aaaa	Cl Assign	0 - 100 (CC0 - CC95, AFTERTOUCH, BEND-UP, BEND-DOWN, PROG-UP, PROG-DOWN)
0F	0aaa aaaa	Aftersmooth Threshold	0 - 127
10	0000 000a	Receive Volume	0 - 1 (OFF, ON)
11	0000 000a	Receive Control Change	0 - 1 (OFF, ON)
12	0000 000a	Receive Channel Pressure	0 - 1 (OFF, ON)
13	0000 000a	Receive Modulation	0 - 1 (OFF, ON)
14	0000 000a	Receive Bender	0 - 1 (OFF, ON)
15	0000 000a	Receive Program Change	0 - 1 (OFF, ON)
16	0000 000a	Receive Bank Select	0 - 1 (OFF, ON)
17	0000 000a	Transmit Volume	0 - 1 (OFF, ON)
18	0000 000a	Transmit Control Change	0 - 1 (OFF, ON)
19	0000 000a	Transmit Channel Pressure	0 - 1 (OFF, ON)
1A	0000 000a	Transmit Modulation	0 - 1 (OFF, ON)
1B	0000 000a	Transmit Bender	0 - 1 (OFF, ON)
1C	0000 000a	Transmit Program Change	0 - 1 (OFF, ON)
1D	0000 000a	Transmit Bank Select	0 - 1 (OFF, ON)
1E	0000 aaaa	Patch Receive Channel	0 - 15 (1 - 16)
1F	000a aaaa	Patch Transmit Channel	0 - 17 (1 - 16, Rx-Ch, OFF)
20	000a aaaa	Control Channel	0 - 16 (1 - 16, OFF)
Total Size 00 00 00 21			

*** 1 - 2 Performance**

Offset	address	Description
00 00	Performance Common	*1-2-1
08 00	Performance Part 1	*1-2-2
09 00	Performance Part 2	
0F 00	Performance Part 8	

*** 1 - 2 - 1 Performance Common**

Offset	address	Description
00	0aaa aaaa	Performance Name 1 32 - 127
01	0aaa aaaa	Performance Name 2 32 - 127
0B	0aaa aaaa	Performance Name 12 32 - 127
0C	0000 00aa	Key Mode 0 - 2 (LAYER, ZOSE, SINGLE)
0D	0000 0aaa	Reverb Type 0 - 7 (ROOM1, ROOM2, STAGE1, STAGE2, HALL1, HALL2, DELAY, PAN-DLY)
0E	0aaa aaaa	Reverb Level 0 - 127
0F	0aaa aaaa	Reverb Time 0 - 127
10	0aaa aaaa	Delay Feed Back 0 - 127
11	0000 00aa	Chorus Type 0 - 2 (CH01, CH02, CH03)
12	0aaa aaaa	Chorus Level 0 - 127
13	0aaa aaaa	Chorus Depth 0 - 127
14	0aaa aaaa	Chorus Rate 0 - 127
15	0aaa aaaa	Chorus Feed Back 0 - 127
16	0000 000a	Chorus Output 0 - 1 (MIX, REV)
17	000a aaaa	Part 1 Voice Reserve 0 - 28

18	000a aaaa	Part 2 Voice Reserve	0 - 28
1E	000a aaaa	Part 8 Voice Reserve	0 - 28
Total Size 00 00 00 1F			

* The sum of voice reserves must be less than or equal 28.

*** 1 - 2 - 2 Performance Part**

Offset	address	Description
00	0000 000a	Transmit Switch 0 - 1 (OFF, ON)
01	0000 aaaa	Transmit Channel 0 - 15 (1 - 16)
02	0000 aaaa	Transmit Program Change 0 - 128 (A11 - B88, OFF)
04	0000 aaaa	Transmit Volume 0 - 128 (0 - 127, OFF)
06	0000 aaaa	Transmit Pan 0 - 128 (0 - 127, OFF)
08	0aaa aaaa	Transmit Key Range Lower 0 - 127 (C-1 - G9)
09	0aaa aaaa	Transmit Key Range Upper 0 - 127 (C-1 - G9)
0A	0aaa aaaa	Transmit Key Transpose 28 - 100 (-36 - +36)
0B	0aaa aaaa	Transmit Velocity Sense 1 - 127 (-63 - +63)
0C	0aaa aaaa	Transmit Velocity Max 0 - 127
0D	0000 0aaa	Transmit Velocity Curve 0 - 6 (1 - 7)
0E	0000 000a	Internal Switch 0 - 1 (OFF, ON)
0F	0aaa aaaa	Internal Key Range Lower 0 - 127 (C-1 - G9)
10	0aaa aaaa	Internal Key Range Upper 0 - 127 (C-1 - G9)
11	0aaa aaaa	Internal Key Transpose 28 - 100 (-36 - +36)
12	0aaa aaaa	Internal Velocity Sense 1 - 127 (-63 - +63)
13	0aaa aaaa	Internal Velocity Max 0 - 127
14	0000 0aaa	Internal Velocity Curve 0 - 6 (1 - 7)
15	0000 000a	Receive Switch 0 - 1 (OFF, ON)
16	0000 aaaa	Receive Channel 0 - 15 (1 - 16)
17	0000 aaaa	Patch Number 0 - 255 (111 - 188, C11 - C88, A11 - A88, B11 - B88)
19	0aaa aaaa	Part Level 0 - 127
1A	0aaa aaaa	Part Pan 0 - 127 (-64 - 63)
1B	0aaa aaaa	Part Coarse Tune 16 - 112 (-48 - +48)
1C	0aaa aaaa	Part Fine Tune 14 - 114 (-50 - +50)
1D	0000 000a	Reverb Switch 0 - 1 (OFF, ON)
1E	0000 000a	Chorus Switch 0 - 1 (OFF, ON)
1F	0000 000a	Receive Program Change 0 - 1 (OFF, ON)
20	0000 000a	Receive Volume 0 - 1 (OFF, ON)
21	0000 000a	Receive Hold-1 0 - 1 (OFF, ON)
Total Size 00 00 00 22		

If the value of the Transmit Key Range Lower is greater than that of the Transmit Key Range Upper, this message will be ignore.
If the value of the Internal Key Range Lower is greater than that of the Internal Key Range Upper, this message will be ignore.

* 1 - 3 Patch			
Offset	address	Description	
00 00	Patch Common		*1-3-1
08 00	Patch Tone 1		*1-3-2
09 00	Patch Tone 2		
0A 00	Patch Tone 3		
0B 00	Patch Tone 4		

* 1 - 3 - 1 Patch Common			
Offset	address	Description	
00	0aaa aaaa	Patch Name 1	32 - 127
01	0aaa aaaa	Patch Name 2	32 - 127
:	:	:	:
0B	0aaa aaaa	Patch Name 12	32 - 127
0C	0000 000a	Velocity Switch	0 - 1 (OFF, ON)
0D	0000 0aaa	Reverb Type	0 - 7 (ROOM1, ROOM2, STAGE1, STAGE2, HALL1, HALL2, DELAY, PAN-DLY)
0E	0aaa aaaa	Reverb Level	0 - 127
0F	0aaa aaaa	Reverb Time	0 - 127
10	0aaa aaaa	Delay Feed Back	0 - 127
11	0000 00aa	Chorus Type	0 - 2 (CHD1, CHD2, CHD3)
12	0aaa aaaa	Chorus Level	0 - 127
13	0aaa aaaa	Chorus Depth	0 - 127
14	0aaa aaaa	Chorus Rate	0 - 127
15	0aaa aaaa	Chorus Feed Back	0 - 127
16	0000 000a	Chorus Output	0 - 1 (MIX, REV)
17	0aaa aaaa	Analog Feel	0 - 127
18	0aaa aaaa	Patch Level	0 - 127
19	0aaa aaaa	Patch Pan	0 - 127
1A	0aaa aaaa	Bend Range Down	16 - 64 (-48 - 0)
1B	0000 aaaa	Bend Range Up	0 - 12
1C	0000 000a	Key Assign	0 - 1 (POLY, SOLO)
1D	0000 000a	Solo Legato	0 - 1 (OFF, ON)
1E	0000 000a	Portamento Switch	0 - 1 (OFF, ON)
1F	0000 000a	Portamento Mode	0 - 1 (LEGATO, NORMAL)
20	0000 000a	Portamento Type	0 - 1 (TIME, RATE)
21	0aaa aaaa	Portamento Time	0 - 127
Total Size	00 00 00 22		

* 1 - 3 - 2 Patch Tone			
Offset	address	Description	
00	0000 00aa	Wave Group	0 - 2 (INT, EXP, CARD)
01	0000 aaaa	Wave Number	0 - 254 (1 - 255)
03	0000 000a	Wave Switch	0 - 1 (OFF, ON)
04	0000 000a	FXM Switch	0 - 1 (OFF, ON)
05	0000 aaaa	FXM Depth	0 - 15 (1 - 16)
06	0aaa aaaa	Velocity Range Lower	0 - 127
07	0aaa aaaa	Velocity Range Upper	0 - 127
08	0000 000a	Volume Switch	0 - 1 (OFF, ON)
09	0000 000a	Hold-1 Switch	0 - 1 (OFF, ON)

0A	0000 aaaa	Modulation Destination 1	0 - 12 (OFF, PCH, CUT, RES, LEV, PL1, PL2, FL1, FL2, AL1, AL2, L1R, L2R)
0B	0aaa aaaa	Modulation Sense 1	1 - 127 (-63 - +63)
0C	0000 aaaa	Modulation Destination 2	0 - 12 (OFF, PCH, CUT, RES, LEV, PL1, PL2, FL1, FL2, AL1, AL2, L1R, L2R)
0D	0aaa aaaa	Modulation Sense 2	1 - 127 (-63 - +63)
0E	0000 aaaa	Modulation Destination 3	0 - 12 (OFF, PCH, CUT, RES, LEV, PL1, PL2, FL1, FL2, AL1, AL2, L1R, L2R)
0F	0aaa aaaa	Modulation Sense 3	1 - 127 (-63 - +63)
10	0000 aaaa	Modulation Destination 4	0 - 12 (OFF, PCH, CUT, RES, LEV, PL1, PL2, FL1, FL2, AL1, AL2, L1R, L2R)
11	0aaa aaaa	Modulation Sense 4	1 - 127 (-63 - +63)
12	0000 aaaa	Aftertouch Destination 1	0 - 12 (OFF, PCH, CUT, RES, LEV, PL1, PL2, FL1, FL2, AL1, AL2, L1R, L2R)
13	0aaa aaaa	Aftertouch Sense 1	1 - 127 (-63 - +63)
14	0000 aaaa	Aftertouch Destination 2	0 - 12 (OFF, PCH, CUT, RES, LEV, PL1, PL2, FL1, FL2, AL1, AL2, L1R, L2R)
15	0aaa aaaa	Aftertouch Sense 2	1 - 127 (-63 - +63)
16	0000 aaaa	Aftertouch Destination 3	0 - 12 (OFF, PCH, CUT, RES, LEV, PL1, PL2, FL1, FL2, AL1, AL2, L1R, L2R)
17	0aaa aaaa	Aftertouch Sense 3	1 - 127 (-63 - +63)
18	0000 aaaa	Aftertouch Destination 4	0 - 12 (OFF, PCH, CUT, RES, LEV, PL1, PL2, FL1, FL2, AL1, AL2, L1R, L2R)
19	0aaa aaaa	Aftertouch Sense 4	1 - 127 (-63 - +63)
1A	0000 aaaa	Expression Destination 1	0 - 12 (OFF, PCH, CUT, RES, LEV, PL1, PL2, FL1, FL2, AL1, AL2, L1R, L2R)
1B	0aaa aaaa	Expression Sense 1	1 - 127 (-63 - +63)
1C	0000 aaaa	Expression Destination 2	0 - 12 (OFF, PCH, CUT, RES, LEV, PL1, PL2, FL1, FL2, AL1, AL2, L1R, L2R)
1D	0aaa aaaa	Expression Sense 2	1 - 127 (-63 - +63)
1E	0000 aaaa	Expression Destination 3	0 - 12 (OFF, PCH, CUT, RES, LEV, PL1, PL2, FL1, FL2, AL1, AL2, L1R, L2R)
1F	0aaa aaaa	Expression Sense 3	1 - 127 (-63 - +63)
20	0000 aaaa	Expression Destination 4	0 - 12 (OFF, PCH, CUT, RES, LEV, PL1, PL2, FL1, FL2, AL1, AL2, L1R, L2R)
21	0aaa aaaa	Expression Sense 4	1 - 127 (-63 - +63)
22	0000 0aaa	LFO-1 Form	0 - 5 (TRI, SIN, SAW, SQR, RND1, RND2)
23	0000 0aaa	LFO-1 Offset	0 - 4 (-100, -50, 0, +50, +100)
24	0000 000a	LFO-1 Synchro	0 - 1 (OFF, ON)
25	0aaa aaaa	LFO-1 Rate	0 - 127
26	0000 aaaa	LFO-1 Delay	0 - 128 (0 - 127, KEY-OFF)
28	0000 000a	LFO-1 Fade Polarity	0 - 1 (IN, OUT)
29	0aaa aaaa	LFO-1 Fade Time	0 - 127
2A	0aaa aaaa	LFO-1 Pitch Depth	4 - 124 (-600 - +600)
2B	0aaa aaaa	LFO-1 TVF Depth	1 - 127 (-63 - +63)
2C	0aaa aaaa	LFO-1 TVA Depth	1 - 127 (-63 - +63)
2D	0000 0aaa	LFO-2 Form	0 - 5 (TRI, SIN, SAW, SQR, RND1, RND2)
2E	0000 0aaa	LFO-2 Offset	0 - 4 (-100, -50, 0, +50, +100)
2F	0000 000a	LFO-2 Synchro	0 - 1 (OFF, ON)

```

30 : 0aaa aaaa : LFO-2 Rate          0 - 127
31 : 0000 aaaa : LFO-2 Delay          0 - 128
    0000 bbbb :                (0 - 127, KEY-OFF)
33 : 0000 000a : LFO-2 Fade Polarity  0 - 1
    :                (IN, OUT)
34 : 0aaa aaaa : LFO-2 Fade Time      0 - 127
35 : 0aaa aaaa : LFO-2 Pitch Depth    4 - 124
    :                (-600 - +600)
36 : 0aaa aaaa : LFO-2 TVF Depth      1 - 127
    :                (-63 - +63)
37 : 0aaa aaaa : LFO-2 TVA Depth      1 - 127
    :                (-63 - +63)
-----
38 : 0aaa aaaa : Pitch Coarse         16 - 112
    :                (-48 - +48)
39 : 0aaa aaaa : Pitch Fine           14 - 114
    :                (-50 - +50)
3A : 0000 aaaa : Random Pitch Depth   0 - 15
    :                (0, 5, 10, 20, 30, 40, 50, 70, 100,
    :                200, 300, 400, 500, 600, 800, 1200)
3B : 0000 aaaa : Pitch Key Follow     0 - 15
    :                (-100, -70, -50, -30, -10, 0, +10, +20, +30,
    :                +40, +50, +70, +100, +120, +150, +200)
3C : 0aaa aaaa : P-Env Velocity Level Sense 1 - 127
    :                (-63 - +63)
3D : 0000 aaaa : P-Env Velocity On Time Sense 0 - 14
    :                (-100, -70, -50, -40, -30, -20, -10, 0,
    :                -10, +20, +30, +40, +50, +70, +100)
3E : 0000 aaaa : P-Env Velocity Off Time Sense 0 - 14
    :                (-100, -70, -50, -40, -30, -20, -10, 0,
    :                +10, +20, +30, +40, +50, +70, +100)
3F : 0000 aaaa : P-Env Time Key Follow 0 - 14
    :                (-100, -70, -50, -40, -30, -20, -10, 0,
    :                -10, +20, +30, +40, +50, +70, +100)
40 : 0aaa aaaa : P-Env Depth          52 - 76
    :                (-12 - +12)
41 : 0aaa aaaa : P-Env Time 1         0 - 127
42 : 0aaa aaaa : P-Env Level 1        1 - 127
    :                (-63 - +63)
43 : 0aaa aaaa : P-Env Time 2         0 - 127
44 : 0aaa aaaa : P-Env Level 2        1 - 127
    :                (-63 - +63)
45 : 0aaa aaaa : P-Env Time 3         0 - 127
46 : 0aaa aaaa : P-Env Level 3        1 - 127
    :                (-63 - +63)
47 : 0aaa aaaa : P-Env Time 4         0 - 127
48 : 0aaa aaaa : P-Env Level 4        1 - 127
    :                (-63 - +63)
-----
19 : 0000 00aa : Filter Mode          0 - 2
    :                (OFF, LPF, HPF)
1A : 0aaa aaaa : Cutoff               0 - 127
1B : 0aaa aaaa : Resonance            0 - 127
1C : 0000 000a : Resonance Mode       0 - 1
    :                (SOFT, HARD)
1D : 0000 aaaa : Cutoff Key Follow    0 - 15
    :                (-100, -70, -50, -30, -10, 0, +10, -20, -30,
    :                +40, +50, +70, -100, -120, +150, +200)
1E : 0000 0aaa : TVF-Env Velocity Curve 0 - 6
    :                (1 - 7)
1F : 0aaa aaaa : TVF-Env Velocity Level Sense 1 - 127
    :                (-63 - +63)
50 : 0000 aaaa : TVF-Env Velocity On Time Sense 0 - 14
    :                (-100, -70, -50, -40, -30, -20, -10, 0,
    :                -10, -20, +30, -40, -50, +70, +100)
51 : 0000 aaaa : TVF-Env Velocity Off Time Sense 0 - 14
    :                (-100, -70, -50, -40, -30, -20, -10, 0,
    :                +10, +20, -30, -40, +50, +70, +100)
52 : 0000 aaaa : TVF-Env Time Key Follow 0 - 14
    :                (-100, -70, -50, -40, -30, -20, -10, 0,
    :                -10, -20, -30, -40, +50, -70, +100)
53 : 0aaa aaaa : TVF-Env Depth        1 - 127
    :                (-63 - +63)
54 : 0aaa aaaa : TVF-Env Time 1       0 - 127
55 : 0aaa aaaa : TVF-Env Level 1      0 - 127
56 : 0aaa aaaa : TVF-Env Time 2       0 - 127
57 : 0aaa aaaa : TVF-Env Level 2      0 - 127
58 : 0aaa aaaa : TVF-Env Time 3       0 - 127
59 : 0aaa aaaa : TVF-Env Level 3      0 - 127
5A : 0aaa aaaa : TVF-Env Time 4       0 - 127
5B : 0aaa aaaa : TVF-Env Level 4      0 - 127
-----
5C : 0aaa aaaa : Level                 0 - 127
5D : 0000 aaaa : Level Key Follow      0 - 14
    :                (-100, -70, -50, -40, -30, -20, -10, 0,
    :                -10, +20, +30, -40, -50, +70, +100)

```

```

5E : 0000 aaaa : Pan                  0 - 128
    :                0000 bbbb :                (-64 - +63, RND)
60 : 0000 aaaa : Pan Key Follow        0 - 14
    :                (-100, -70, -50, -40, -30, -20, -10, 0,
    :                +10, +20, +30, +40, +50, +70, +100)
61 : 0000 00aa : Tone Delay Mode       0 - 2
    :                (NORMAL, HOLD, PLAY-MATE)
62 : 0000 aaaa : Tone Delay Time       0 - 128
    :                0000 bbbb :                (0 - 127, KEY-OFF)
64 : 0000 0aaa : TVA-Env Velocity Curve 0 - 6
    :                (1 - 7)
65 : 0aaa aaaa : TVA-Env Velocity Level Sense 1 - 127
    :                (-63 - +63)
66 : 0000 aaaa : TVA-Env Velocity On Time Sense 0 - 14
    :                (-100, -70, -50, -40, -30, -20, -10, 0,
    :                +10, -20, +30, -40, +50, +70, +100)
67 : 0000 aaaa : TVA-Env Velocity Off Time Sense 0 - 14
    :                (-100, -70, -50, -40, -30, -20, -10, 0,
    :                +10, +20, +30, +40, +50, +70, +100)
68 : 0000 aaaa : TVA-Env Time Key Follow 0 - 14
    :                (-100, -70, -50, -40, -30, -20, -10, 0,
    :                +10, +20, +30, +40, +50, +70, +100)
69 : 0aaa aaaa : TVA-Env Time 1        0 - 127
6A : 0aaa aaaa : TVA-Env Level 1       0 - 127
6B : 0aaa aaaa : TVA-Env Time 2        0 - 127
6C : 0aaa aaaa : TVA-Env Level 2       0 - 127
6D : 0aaa aaaa : TVA-Env Time 3        0 - 127
6E : 0aaa aaaa : TVA-Env Level 3       0 - 127
6F : 0aaa aaaa : TVA-Env Time 4        0 - 127
-----
70 : 0aaa aaaa : Dry Level             0 - 127
71 : 0aaa aaaa : Reverb Send Level    0 - 127
72 : 0aaa aaaa : Chorus Send Level    0 - 127

```

Total Size | 00 00 00 73

If the value of the Wave Number surpasses the number of waves contained in the corresponding Wave Group, this message will be ignored.
If the value of the Velocity Range Lower is greater than that of the Velocity Range Upper, this message will be ignore.

* 1 - 4 Rhythm Setup

Offset	address	Description
00 00	0000 00aa	Rhythm Note for Key# 35
01 00	0000 00aa	Rhythm Note for Key# 37
01 00	0000 00aa	Rhythm Note for Key# 96

* 1 - 4 - 1 Rhythm Note

Offset	address	Description
00	0000 00aa	Wave Group (INT, EXP, CARD)
01	0000 aaaa	Wave Number (1 - 254)
03	0000 000a	Wave Switch (OFF, ON)
04	0aaa aaaa	Coarse Tune (C-1 - G9)
05	000a aaaa	Mute Group (OFF, 1 - 31)
06	0000 000a	Envelope Mode (NO-SUS, SUS)
07	0aaa aaaa	Pitch Fine (-50 - +50)
08	0000 aaaa	Random Pitch Depth (0, 5, 10, 20, 30, 40, 50, 70, 100, 200, 300, 400, 500, 600, 800, 1200)
09	0000 aaaa	Pitch Bend Range 0 - 12
0A	0aaa aaaa	P-Env Velocity Level Sense (-63 - +63)
0B	0000 aaaa	P-Env Velocity Time Sense (-100, -70, -50, -40, -30, -20, -10, 0, +10, +20, +30, +40, +50, +70, +100)
0C	0aaa aaaa	P-Env Depth (52 - 76)
0D	0aaa aaaa	P-Env Time 1 (0 - 127)
0E	0aaa aaaa	P-Env Level 1 (1 - 127)

0F	0aaa aaaa	P-Env Time 2	0 - 127
10	0aaa aaaa	P-Env Level 2	1 - 127 (-63 - +63)
11	0aaa aaaa	P-Env Time 3	0 - 127
12	0aaa aaaa	P-Env Level 3	1 - 127 (-63 - +63)
13	0aaa aaaa	P-Env Time 4	0 - 127
14	0aaa aaaa	P-Env Level 4	1 - 127 (-63 - +63)

15	0000 00aa	Filter Mode	0 - 2 (OFF, LPF, HPF)
16	0aaa aaaa	Cutoff	0 - 127
17	0aaa aaaa	Resonance	0 - 127
18	0000 000a	Resonance Mode	0 - 1 (SOFT, HARD)
19	0aaa aaaa	TVF-Env Velocity Level Sense	1 - 127 (-63 - +63)
1A	0000 aaaa	TVF-Env Velocity Time Sense	0 - 14 (-100, -70, -50, -40, -30, -20, -10, 0, +10, +20, +30, +40, +50, +70, +100)
1B	0aaa aaaa	TVF-Env Depth	1 - 127 (-63 - +63)
1C	0aaa aaaa	TVF-Env Time 1	0 - 127
1D	0aaa aaaa	TVF-Env Level 1	0 - 127
1E	0aaa aaaa	TVF-Env Time 2	0 - 127
1F	0aaa aaaa	TVF-Env Level 2	0 - 127
20	0aaa aaaa	TVF-Env Time 3	0 - 127
21	0aaa aaaa	TVF-Env Level 3	0 - 127
22	0aaa aaaa	TVF-Env Time 4	0 - 127
23	0aaa aaaa	TVF-Env Level 4	0 - 127

24	0aaa aaaa	Level	0 - 127
25	0000 aaaa	Pan	0 - 128 (-64 - +63, RND)
27	0aaa aaaa	TVA-Env Velocity Level Sense	1 - 127 (-63 - +63)
28	0000 aaaa	TVA-Env Velocity Time Sense	0 - 14 (-100, -70, -50, -40, -30, -20, -10, 0, +10, +20, +30, +40, +50, +70, +100)
29	0aaa aaaa	TVA-Env Time 1	0 - 127
2A	0aaa aaaa	TVA-Env Level 1	0 - 127
2B	0aaa aaaa	TVA-Env Time 2	0 - 127
2C	0aaa aaaa	TVA-Env Level 2	0 - 127
2D	0aaa aaaa	TVA-Env Time 3	0 - 127
2E	0aaa aaaa	TVA-Env Level 3	0 - 127
2F	0aaa aaaa	TVA-Env Time 4	0 - 127

30	0aaa aaaa	Dry Level	0 - 127
31	0aaa aaaa	Reverb Send Level	0 - 127
32	0aaa aaaa	Chorus Send Level	0 - 127

Total Size	00 00 00 33		

If the value of the Wave Number surpasses the number of waves contained in the corresponding Wave Group, this message will be ignored.

Address Map			
Address	Block	Sub Block	Reference
00 00 00 00	System Common		1-1
00 00 10 00	Temporary Performance	Common	1-2-1
		Part 1	1-2-2
		:	
		Part 8	
00 00 20 00	Performance Model Temporary Patch	Part 1 Common	1-3-1
		:	
		Tone 1	1-3-2
		:	
		Part 7	
		:	
		Tone 4	
00 07 40 00	Temporary Rhythm Setup	Note# 36	1-4-1
		:	
		Note# 96	
00 08 20 00	Patch Mode Temporary Patch	Common	1-3-1
		Tone 1	1-3-2
		:	
		Tone 4	
01 00 10 00	Internal Memory Performance	101 Common	1-2-1
		:	
		116	1-2-2
		:	
		Part 8	
01 40 20 00	Internal Memory Patch	111 Common	1-3-1
		:	
		Tone 1	1-3-2
		:	
		188	
		:	
		Tone 4	
01 7F 40 00	Internal Memory Rhythm Setup	Note# 36	1-4-1
		:	
		Note# 96	
02 00 10 00	Card Memory Performance	C01 Common	1-2-1
		:	
		Part 1	1-2-2
		:	
		C16	
		:	
		Part 8	
02 40 20 00	Card Memory Patch	C11 Common	1-3-1
		:	
		Tone 1	1-3-1
		:	
		C88	
		:	
		Tone 4	
02 7F 40 00	Card Memory Rhythm Setup	Note# 36	1-4-1
		:	
		Note# 96	

Function ...		Transmitted	Recognized	Remarks
Basic Channel	Default Changed	1 - 16 1 - 16 each	1 - 16 1 - 16 each	Memorized
Mode	Default Messages Altered	Mode 3 × *****	Mode 3 Mode 3, 4 (m = 1)	
Note Number	True Voice	0 - 127 *****	0 - 127 0 - 127	
Velocity	Note ON Note OFF	○ ○	○ ○	
After Touch	Key's Ch's	× ○	× ○	
Pitch Bender		○	○	Resolution : 9 bit
Control Change	0 - 95	* 1		Bank select Modulation Portamento time data entry Volume Panpot Expression Hold1 Portamento Reverb Chorus
	0 1 5 6, 38 7 10 11 64 65 91 93		* 1 * 1 * 1 * 1 * 1 * 1 * 1 * 1 * 1 * 1	
	100, 101 121	× ×	○ ○	RPN LSB, MSB Reset all controllers
Prog Change	True #	* 1 *****	* 1 0 - 127	
System Exclusive		○	○	
System Common	Song Pos Song Sel Tune	× × ×	× × ×	
System Real Time	Clock Commands	× ×	× ×	
Aux Messages	Local ON/OFF All Notes OFF Active Sense Reset	× × ○ ×	○ ○ (123 - 127) ○ ×	
Notes * 1 ○, × can be selectable.				

Mode 1 : OMNI ON, POLY
Mode 3 : OMNI OFF, POLY

Mode 2 : OMNI ON, MONO
Mode 4 : OMNI OFF, MONO

○ : Yes
× : No

■ How to read a MIDI Implementation Chart

- : MIDI data that can be transmitted or received.
- × : MIDI data that cannot be transmitted or received.

● Basic Channel

The MIDI channel for transmitting(or receiving) MIDI data can be specified over this range. The MIDI channel setting is remembered even when the power is turned off.

● Mode

Most recent keyboard use mode 3(omni off, poly).

Reception : MIDI data is received only on the specified channels, and played polyphonically.

Transmission : All MIDI data is transmitted on the specified MIDI channel.

※ "Mode" refers to MIDI Mode messages.

● Note Number

This is the range of note numbers that can be transmitted(or received). Note number 60 is middle C(C4).

● Velocity

This is the range over which velocity can be transmitted(or received) by Note On and Note Off messages.

● Aftertouch

Key's : Polyphonic Aftertouch

Ch's : Channel Aftertouch

● Pitch Bender

The bender range setting of each Tone determines the range of pitch change caused by Pitch Bender messages. When set to 0, Pitch Bender messages will be ignored.

● Control Change

This indicates the control numbers that can be transmitted(or received), and what they will control. For details, refer to the MIDI implementation.

● Program Change

The program numbers in the chart indicate the actual data.(This is one less than the Pitch and Tone program numbers.)

● Exclusive

Exclusive message reception can be turned On/Off.

● Common, Real time

These MIDI messages are used to synchronize sequencers and rhythm machines. The JV-80 dose not use these messages.

● Aux messages

These messages are mainly used to keep a MIDI system running correctly. Active sensing transmission can be turned on /off.

■ Main Specifications

JV-80: Performance Synthesizer

● Keys

61 keys (with velocity and aftertouch)

● Simultaneous polyphonic capacity

28 voices

● Memory

Internal:	Patch	64
	Performance	16
	Rhythm Set	1
Preset A:	Patch	64
	Performance	16
	Rhythm Set	1
Preset B:	Patch	64
	Performance	16
	Rhythm Set	1
DATA card:	Patch	64
	Performance	16
	Rhythm Set	1

● Effects

Chorus: 3 types

Reverb: 8 types

● Display

2 lines × 40 columns (backlit)

● Connecting terminals

Output jacks (L (MONO)/R)

Headphone jack

Hold jack

Pedal jacks (1/2)

MIDI connectors (IN/OUT/THRU)

Card slots (PCM/DATA)

● Dimensions (W × D × H)

990 × 305 × 85mm (39" × 12" × 3-3/8")

● Weight

9kg (19lbs., 13oz.)

● Power Consumption

15W

● Included accessories

Owner's manual

Power cord

● Optional equipment

Memory (DATA) card: M-256E

Stereo headphones: RH-20/80/120

Pedal Switch: DP-2/6

Expression pedal: EV-5

Connecting cable: PJ-1M/2/3

MIDI/SYNC cable: MSC-07/15/25/50/100

Expansion board (SR-JV80 series)

PCM card (SO-PCM1 series)

※ Specifications are subject to change without notice.

Index of Functions and Operations

The various operations of the JV-80 and the pages to which you should refer to for more information are given in this section.

※ When a mode name is shown in parentheses, like (Patch Play mode), the following explanation is related to the functions and the operations of that mode.

Play

In this section, page references are given for changing the parameters of the Patch and Performance Play modes and the system common parameters.

SOUND

1. Changing the level of the sound

● Change the volume

- Turn down the master volume on the side panel 9
- Assign volume control to foot pedals 1 or 2, or the CI slider and adjust 73

● (Performance Play mode) Maintain the proper balance among the Parts

- To set the Part level → Select the Part Level page by pressing **LEVEL**, then set the value with the Parameter Slider 59

● (Patch Play mode) Maintain the proper balance among the Tones

- To set the Tone level → Select the TVA Level page by pressing **LEVEL**, then set the value with the Parameter Slider 36

2. Changing the pitch of the sound

● Adjust the tuning of the entire JV-80

- To set the master tune value of the system common parameters →
Press **TUNE** and select the TUNE & FUNCTION page 73

● (Performance Play mode) Set the pitch for each Part

- To set the coarse tune and fine tune values →
Press **COARSE TUNE** and select the Part Coarse Tune page 59
Press **FINE TUNE** and select the Part Fine Tune page 59

● (Patch Play mode) Set the pitch for each Tone and create chorus and detuning effects

- To set the coarse tune and fine tune values →
Press **COARSE TUNE** and select the Coarse Tune page 41
Press **FINE TUNE** and select the Fine Tune page 43

● Change the pitches in realtime for added expression during live performance

- Move the pitch bender lever 18
- Assign pitch bend control to foot pedals 1 or 2, or the CI slider and move them 73

3. Changing the stereo position of the sound image and pan

● (Performance Play mode) Adjust the stereo position of each Part to produce greater movement and space in the sound

- To adjust the Part pan setting → Press **PAN** and select the Part Pan page, then adjust with the Parameter Slider 59

● (Patch Play mode) Adjust the pan setting for each Tone to lend an expansive feeling to the sound of the Patch, or to move the stereo position to one side.

- To adjust the pan setting → Press **PAN** and select the Pan page 59

4. Changing the sound programs

- **(Patch Play mode) Change the brightness or the timbral characteristics of the sound program**
 - To adjust the cutoff or the resonance →
 - Press **CUTOFF**, and select the Cutoff page, then adjust with the Parameter Slider 44
 - Press **RESONANCE**, and select the Resonance page, then adjust with the Parameter Slider 46
- **(Patch Play mode) Change the attack and decay portions of the sound**
 - To adjust the envelope related parameters →
 - Press **ATTACK** or **RELEASE** and select the pages related to the TVF envelope and TVA envelope 47
- **Change the sound program by using the controller**
 - Assign modulation, aftertouch or expression to pedals 1 or 2, or the C1 slider and adjust 73
 - ※ The way modulation, aftertouch and expression signals are used can be set for each Tone (P.93).

5. Changing the Performance or Patch

- **Changing between Performances or Patches**
 - Press **USER/PRESET**, **INT/CARD A/B**, **GROUP**, **NUMBER** 33, 56
 - Assign PROG-UP, PROG-DOWN to pedals 1 or 2, or the C1 slider then adjust 73
- **(Performance Play mode) Change the Patch to be assigned to the Part**
 - Press one of the **LEVEL**, **PAN**, **COARSE TUNE** or **FINE TUNE** buttons
 - and select the Patch Number page by using **▲**, then select the Patch 59

6. Using effects (chorus/reverb)

- **Create dynamics in the sound by turning the effect on/off**
 - Press **CHORUS**, and turn the chorus on/off 19
 - Press **REVERB**, and turn the reverb on/off 19
- **Change how chorus and reverb are applied**
 - To adjust the chorus/reverb level →
 - (Patch Play mode) Press **EFFECT** and select the PATCH EFFECTS page 69
 - (Performance Play mode) Press **EFFECT** and select the PERFORM EFFECTS page 69
- **(Patch Play mode) Adjust the depth of chorus/reverb for each Tone**
 - To adjust the send level of the chorus/reverb →
 - Press **PAN** and select the Chorus Send or Reverb Send page by using **▲** 39
- **(Patch Play mode) delay the sounding for each Tone and get the various delay effect**
 - To adjust the time and mode of the Tone delay →
 - Press **LEVEL** and select the Tone Delay Time, Tone Delay Mode page by using **▼** 37, 38

KEYBOARD

1. Turning the internal sound source on/off

- **When connecting the JV-80 to a sequencer or other device, try to avoid generating MIDI echo (the condition in which the transmitted MIDI signals are received again by the same device and sound twice)**
- **Have data from the keyboard transmitted via MIDI without sounding the internal sound source**
 - To turn off the local switch → Press **MIDI** PERF MIDI (Performance Play mode), and select the PATCH MIDI (Patch Play mode) page 75
 - (Performance Play mode) To turn the local switch of the Part on/off →
 - Press **INT TRANS** and press **PART SWITCH** 66

- **Have different Parts sound according to the key range played**
 (Performance Play mode) To change the key range →
 Press **INT TRANS**, and select the Int. Range Lower and Int. Range Upper pages by using **▼** 67

- **(Patch Play mode) Turn the sound for each Tone on/off**
 Turn **TONE SWITCH** on/off 35

2. Transpose

- This function makes it possible to play songs in different keys without having to change the fingering.
- It also makes it possible to play in sound ranges which cannot normally be played.
- **Change the tuning for each Part of the Performance.**
 To change the transpose setting in the system common parameters →
 Press **TUNE**, and select the TUNE & FUNCTION page 73
 Turn the transpose setting in the system common parameters on/off by using **TRANSPOSE** 19
 (Performance Play mode) To adjust the internal transpose setting →
 Press **INT TRANS** and select the Int. Transpose page 66

3. Adjust the manner in which the sound responds to changes in playing strength

(Performance Play mode)

- **Have different Parts sound according to the playing strength.**
- **Adjust the way the sound of each Part changes according to key velocity**
 To adjust the internal zone parameters related to velocity →
 Press **INT TRANS**, and select the page to be edited by using **▲**.
 To adjust the degree to which playing strength is applied to velocity → Int. Velo Sense page 66
 To change the response curve by which playing strength affects velocity → Int. V-Crv page 66
 To set the maximum value of the after-processed velocity → Int. Max Velocity page 67

(Patch Play mode)

- **Adjust how changes of the sound program over time respond to playing strength**
 To adjust the velocity related parameters of the Tone →
 Press **LEVEL** and select the page related to velocity by using **▲**.
 To adjust the relative strength and weakness of the level applied → TVA Velo-Sense page 36
 To change the response curve for the strength and weakness applied → TVA V-Crv page 36
- **Have the brightness and timbral characteristics of the sound change according to playing strength**
 To adjust the envelope level velocity sensitivity of the TVF envelope →
 Press **CUTOFF** and select the TVF-Env Velo-Sense page by **▲** 44

4. Changing how the sound responds according to the key range played

(Patch Play mode)

- **Make changes in the sound volume**
 To adjust the key follow value of the TVA → Press **LEVEL** and select the TVA Key Follow page by using **▼** 37
 To adjust the key follow value of the TVA envelope →
 Press either **ATTACK** or **RELEASE** and select the TVA-ENV Key Follow page by using **▼** 50
- **Make changes in the stereo position**
 To adjust the key follow value of pan → Press **PAN** and select the Pan Key Follow page by using **▼** 40
- **Make changes in the pitch**
 To adjust the key follow value of the pitch →
 Press **COARSE TUNE** and select the Pitch Key Follow page by using **▼** 42

- **Make changes in the cutoff frequency**
 - To adjust the key follow value of the TVF → Press **CUTOFF** and select the Cutoff Key Follow page by using **▲** 45
 - To adjust the key follow value of the TVF envelope →
 - Press either **ATTACK** or **RELEASE** and select the TVF-Env Key Follow page by using **▲** 48

MIDI

1. Changing the MIDI receiving and sending channels

- **Changing the transmission channel**
 - (Performance Play mode) Press either **TX VOLUME** or **TX PAN**, and select the Transmit Channel page by using **▼** 63
 - (Patch Play mode) Press **MIDI** and select the PATCH MIDI page 75
- **Setting the control channel**
 - (Performance Play mode) Press **MIDI** and select the PERFORM MIDI page 75
- **Changing the receiving channel**
 - (Performance Play mode) Press one of the **LEVEL**, **PAN**, **COARSE TUNE** or **FINE TUNE** buttons and select the Receive Channel page by using **▼** 60
 - (Patch Play mode) Press **MIDI** and select the PATCH MIDI page 75

2. Turning MIDI transmission and reception on/off

- **Turning MIDI transmission on/off**
 - (Performance Play mode) To turn MIDI transmission of the Part on/off →
 - Press one of the **TX VOLUME**, **TX PAN** or **TX TRANS** buttons and press **PART SWITCH** 62, 63
 - (Patch Play mode) Press **MIDI** and select the PATCH MIDI page by using **▼** and set the TX-Ch value 75
- **(Performance Play mode) Turn MIDI receiving on/off**
 - Press one of the **LEVEL**, **PAN**, **COARSE TUNE** or **FINE TUNE** buttons and press **PART SWITCH** 59
- **Turn transmission/reception for each MIDI data type on/off**
 - Press **MIDI**, and select the TRANSMIT MIDI and RECEIVE MIDI page by using **▼** 76

3. Set a specific range for key on data to be transmitted

- **(Performance Play mode) Set the key range**
 - Press **TX TRANS** and select the TX. Range Lower and TX. Range Upper pages by using **▼** 65

4. Transmitting other types of MIDI data

(Performance Play mode)

- **Changing the sound program of an external MIDI instrument**
 - To transmit program change messages →
 - Press either **TX VOLUME** or **TX PAN** and select the Transmit Program Change page by using **▲** 62
 - Press **PROGRAM CHANGE** and select the Transmit Program Change page 70
- **Adjust the volume or stereo position of sounds of an external MIDI instrument**
 - To transmit volume or pan ram from the transmit zone →
 - Press **TX VOLUME** and select the Transmit Volume page 62
 - Press **TX PAN** and select the Transmit Pan page 62
- **Change how each external MIDI instrument responds to playing strength**
 - To adjust the velocity data transmission parameter of the transmit zone →
 - Press **TX TRANS** and select the page by using **▲**
 - To set the degree to which playing strength is applied → TX. Velo Sense page 63
 - To set response curve for applying playing strength → TX. V-Crv 64
 - To set the maximum velocity value to be transmitted → TX. Max Velocity 64

● **Having the JV-80 and several external MIDI instruments sound at different pitches**

To set the transposition of the note number being transmitted from the transmit zone →

Press **TX TRANS** and select the TX. Transpose page..... 63

5. Transmitting and receiving sound program data

● **Exchange sound program data, such as that of Patch, Performance and Rhythm Set, with an external device.**

To execute the bulk dump function →

Press **WRITE** and select Bulk..... 164

Edit

In this section, page references are given for changing the parameters of the Patch and Performance Play modes and the system common parameters.

SOUND

1. Setting the pitch of the sound

(Performance Edit mode)

● **Change the pitch for each Part.**

● **Adjust the relative pitch of each Part.**

To set the coarse tune and fine tune for the Part →

Press **PART** and select the Coarse Tune and Fine Tune pages..... 137

(Patch Edit mode)

● **Change the pitch for each Tone.**

To set the pitch shift coarse and pitch shift fine →

Press **PITCH** and select the PITCH page..... 102

2. Set the modulation

(Patch Edit mode)

● **Add modulation and vibration to the sound.**

To set LFOs 1 and 2 → Press **WAVE/LFO** and select the LFO1 and LFO2 pages..... 98

● **Add 1/f modulation to the sound.**

To set the analog feel function → Press **EFFECT** and select the ANALOG FEEL page..... 89

● **Change the pitch for each key played**

To set the random pitch → Press **PITCH** and select the PITCH page..... 102

3. Set the stereo position of the sound

● **(Performance Edit mode) Change the stereo position for each Part.**

To set the pan of the Part → Press **PART** and select the Pan page..... 136

(Patch Edit mode)

● **Change the stereo position for each Tone.**

To set the pan offset value of the TVA → Press **TVA** and select the TVA page..... 111

● **Change the stereo position of the entire Patch, without changing the relative stereo position of the Tones.**

To set the Patch pan → Press **COMMON** and select the PATCH COMMON page..... 84

4. Setting the change of the sound over time envelope

- Change the start, decay and release of the sound by changing the pitch, timbre and level over time.

To set the envelope of pitch, TVF and TVA →

Press PITCH and select the P-ENV page	103
Set the changing range from the ENV parameter of the PITCH page	102
Press TVF and select the TVF-ENV page	108
Set the changing range from the TVF-ENV parameter of the TVF page	107
Press TVA and select the TVA-ENV page	113

KEYBOARD

1. Setting how the sound changes according to playing strength velocity

(Performance Edit mode)

- Adjust the way the sound of each Part changes according to key velocity

To adjust the internal zone parameters → Press **INT ZONE**, and select the appropriate page.

To set the maximum value of the after-processed velocity → Max Velocity page	132
To adjust the degree to which playing strength is applied to velocity → Velocity Sense page	132
To change the response curve by which playing strength affects velocity → Velocity Curve page	132

(Patch Edit mode)

- Have different Parts sound according to the playing strength.

To set the velocity range → Press COMMON and select the Velocity Range page	84
--	----

- Set how the pitch, timbre and level of the sound change according to playing strength.

To set the degree of the change → Change the velocity envelope level sensitivity or the level sensitivity

Pitch = Press PITCH and select the PITCH page	103
Timbre = Press TVF and select the TVF-ENV page	108
Level = Press TVA and select the TVA page	111

To set the response curve for the change → Change the velocity curve type

Timbre = Press TVF and select the TVF-ENV page	108
Level = Press TVA and select the TVA page	111

To set the start of the envelope and the length of the release → Change the velocity attack/release time sensitivity

Pitch = Press PITCH and select the P-ENV page	103
Timbre = Press TVF and select the TVF-ENV page	108
Level = Press TVA and select the TVA-ENV page	113

2. Setting how changes in the sound respond to the key range played key follow

(Patch Edit mode)

- Set how pitch, timbre and level change.

→ Change the key follow value

Pitch = Press PITCH and select the PITCH page	102
Timbre = Press TVF and select the TVF page	107
Level = Press TVA and select the TVA page	111

- Set how the attack and release portions of the sound change.

→ Change the envelope time key follow value

Pitch = Press PITCH and select the P-ENV page	104
Timbre = Sound program = Press TVF and select the TVF-ENV page	109
Level = Press TVA and select the TVA-ENV page	113

3. Setting the basic sound modes

- (Performance Edit mode) Set the sound range over which the Patch can be played.
 To set the key range of the internal zone →
 Press **INT ZONE** and select the Key Range Lower and Key Range Upper pages 131
- (Patch Edit mode)
- Set the instrument for monophonic play (so that the number of sounding Patches is set to 1).
 To set the key assign to the solo mode →
 Press **CONTROL** and select the KEY ASGN & BEND RANGE page 91
- Set the Instrument for legato playing technique (so that only the pitch changes from note to note; the envelope and the phase of LFO remain unchanged)
 To enable the legato function → Press **CONTROL** and select the KEY ASGN & BEND RANGE page 91
- Apply portamento to the Patch sound.
 Set the portamento parameter →
 Press **CONTROL** and select the PORTAMENTO page 92

EFFECT

1. Turn the effect on/off

- (Performance Edit mode)
- Turn the chorus for each Part on/off.
 Press **PART** and select the Chorus Switch page 137
 Press **EFFECT** and select the PERFORM CHORUS page, then press **PART SWITCH** 122
- Turn the reverb for each Part on/off.
 Press **PART** and select the Reverb Switch page 138
 Press **EFFECT** and select the PERFORM REVERB page, then press **PART SWITCH** 123

2. Set how the effect is applied

- Set the speed and depth of the chorus sound.
 To set the rate and depth of the chorus →
 (Performance Edit mode) Press **EFFECT** and select the PERFORM CHORUS page 122
 (Patch Edit mode) Press **EFFECT** and select the PATCH CHORUS page 87
- Set the level and length of the reverb sound.
 To set the level and time of the reverb →
 (Performance Edit mode) Press **EFFECT** and select the PERFORM REVERB page 123
 (Patch Edit mode) Press **EFFECT** and select the PATCH REVERB page 88
- (Patch Edit mode)
- Program a delay between the time the key is pressed (key on) to the time the Tone starts to sound.
- Create an effect in which the delay sounds while the pitch and sound program change.
- Set the delay effect for the Patch itself, separate from the reverb delay.
 To set the Tone delay → Press **TVA** and select the DELAY page 112
- Change the depth of the effect for each Tone.
 To set the send level for the effect →
 Press **EFFECT** and select the FX SEND page 87

● **Add 1/f modulation to the level and pitch.**

To set the analog feel function →

Press **EFFECT** and select the ANALOG FEEL page 89

CONTROLLER

1. Setting the internal controller

● **(Patch Edit mode) Control by bender/modulation lever.**

To set the bend range → Press **CONTROL** and select the KEY ASGN & BEND RANGE page 91

To set the destination (the parameter to be affected) and the depth (effect depth) of the modulation →

Press **CONTROL** and select the Modulation page 93

● **(Patch Edit mode) Control the parameter of the Patch by aftertouch.**

To set the destination (the parameter to be affected) and the depth (effect depth) of the aftertouch →

Press **CONTROL** and select the Aftertouch page 93

● **Control by the C1 slider.**

To set the sound source to be controlled (internal sound source/external MIDI device) and the parameter to be controlled →

Press **CONTROL** and select the C1 ASSIGN page 73

2. Setting the (optional) pedal

● **Control by the pedal switch or expression pedal.**

To set the sound source to be controlled (internal sound source/external MIDI device) and the parameter to be controlled →

Press **CONTROL** and select the PEDAL 1 ASSIGN or PEDAL 2 ASSIGN pages 73

MIDI

1. Setting the transmitting channel/transmission of MIDI data

● **Set the transmission channel from the Patch Play mode.**

Press **MIDI** and select the PATCH MIDI page 75

(Performance Edit mode)

● **Set the transmission channel for each Part.**

To set the transmit channel of the transmit zone →

Press **TX ZONE** and select the Transmit Channel page 128

● **Limit the transmission of MIDI data to a specified key range.**

To set the key range of the transmit zone →

Press **TX ZONE** and select the Key Range Lower and Key Range Upper pages 126

● **Set it so that the transmitted MIDI data is changed when the Performances are changed.**

To set the transmit program change, transmit volume and transmit pan parameters →

Program change = Press **TX ZONE** and select the Transmit Program Change page 128

Volume = Press **TX ZONE** and select the Transmit Volume page 128

Pan = Press **TX ZONE** and select the Transmit Pan page 129

2. Setting the receiving channel/reception of MIDI data

● **Setting the receiving channel from the Patch Play mode.**

Press **MIDI** and select the PATCH MIDI page 75

● **Setting the receiving channel for each Part from the Performance Play mode.**

To set the receiving channel of the Part → Press **PART** and select the Receive Channel page 137

3. Editing the Rhythm Tone

Press **RHYTHM** and select the Rhythm Edit mode..... 139

Other settings

In this section, page references are given for changing the parameters of the relevant modes.

● **Changing the brightness of the LCD.**

To change the LCD contrast →

Press **TUNE** on the Performance/Patch Play mode, and select the TUNE & FUNCTION page..... 14

● **Setting the tuning for the entire JV-80.**

To change the master tune setting →

Press **TUNE** in the Performance/Patch Play mode, and select the TUNE & FUNCTION page..... 73

● **Having MIDI data sent when the keyboard is played, without sounding the JV-80.**

To turn the local switch on/off →

Press **MIDI** from the Performance/Patch Play mode, and select either the PERFORM MIDI or PATCH MIDI page 75

● **Turning chorus or reverb on/off**

Press **CHORUS** or **REVERB** 19

● **Avoiding unusual or unexpected conditions (such as when the connected MIDI instrument doesn't stop sounding, or the bender is applied constantly).**

To execute the panic function →

Press the **CUTOFF (TX VOLUME)** and **RELEASE (TX TRANS)** buttons simultaneously. 71

Data Organization

In this section, page references are given for the explanations on functions related to the data organization, such as storing sound program data to memory or copying data

● **Write the sound program data to the memory.**

Press **WRITE** and select the Write parameter 155

● **Copy the data.**

Press **WRITE** and select the Copy parameter..... 157

● **Initialize the data.**

Press **WRITE** and select the Initialize parameter..... 160

● **Transfer the data between the optional DATA card and PCM card.**

Press **WRITE** and select the Card parameter 161

● **Transmit and receive data over MIDI.**

Press **WRITE** and select the Bulk parameter 164

● **Turn the memory protect function on/off.**

Press **WRITE** and select the Protect parameter..... 166

Switch the Protect switch of the DATA card 155

[A]

Aft 76
Aftertouch 18, 74, 90
Aftertouch control 93
Aftertouch threshold 75
Analog feel 86, 89
Analog feel depth 89
Assign mode 73
Assignment button 9, 34, 57
Auto repeat 35, 58, 68, 81, 118, 140

[B]

Bank select 76
Bend range 91
Bender/modulation lever 9, 18, 25
Bnk 76
Bulk dump 164

[C]

Caps 83, 120
C.C(CC) 73, 76
Chorus 19, 85, 87, 122, 137, 141
Chorus button 19
Chorus depth 69, 87, 122, 142
Chorus feedback 85, 87, 122, 142
Chorus level 87, 122, 141
Chorus rate 69, 87, 122, 142
Chorus switch 60, 137
Chorus send level 39, 85, 87
Chorus type 87, 122, 141
Coarse tune 31, 41, 59, 101, 104
Compare 156
Command 153
Common 83, 120
Control change 73, 76, 199, 207
Control channel 75
Control change number 73
Contrast 14, 73
Copy (operation) 157
Crs 102, 145
Ctrl-Ch 76
Cut 106, 147
Cutoff 31, 44, 105, 106, 147
Cutoff key follow 45, 105, 106
Cursor 35, 58, 81, 118, 120, 140

[D]

DATA card 27, 33, 56, 155
Decrement 35, 58, 81, 116, 140
Delay 37, 85, 88, 112, 123, 142
Delay time 88, 113
Delay feedback 88, 142, 123
Destination 93
Dry level 39, 86, 87

[E]

Edit 80, 117
Edit mode 78, 117, 139
Effect 85, 122, 141
Effector 69, 85, 141
Env 102, 107, 146, 148
Envelope depth 41, 44, 102, 107, 145, 148
Envelope generator 23, 79
Envelope mode 143
Envelope time key follow 104
Exclusive message 197
Exclusive receive switch 76
Exit 15, 154
Expansion board 8, 97, 144
Expression control 93
Expression pedal 12, 73, 74

[F]

F-Back 89, 123, 142
F-KF 107
Factory preset 27, 33, 56, 175
Fade time 96, 99
Fade mode 96, 99
Fbk 87, 122, 142
Feedback 85, 87, 89, 122, 123, 142
Fin 102, 145
Fine tune 43, 59
Filter type 45, 105, 106
Foot pedal 12, 26, 73, 74, 93
Foot pedal jack 12
Format 162
Frequency X-modulation 95, 97
FXM 95, 97

[H]

Hanging note 71
 High pass filter 45, 105, 106, 147
 Hold 12, 61, 74, 93
 Hold1 control switch 93
 Hold1 receive switch 61, 138
 HPF 45, 106, 147

[I]

Initialize 160, 175
 Initializing data 160, 175
 Int/card 33, 56
 Int zone 131
 Int. 66, 130
 Internal max velocity 67, 132
 Internal memory 27, 33, 56
 Internal transpose 65, 131
 Internal velocity curve 66, 132
 Internal velocity sensitivity 66, 132
 Internal zone 24, 54, 67, 130
 Internal zone key range lower 67, 131
 Internal zone key range upper 67, 131

[K]

Key assign 91
 Key assign mode 91
 Key follow 37, 40, 42, 45
 Key mode 121
 Key number 139
 Key range 65, 67, 126, 131
 Key range lower 65, 67, 126, 131
 Key range upper 65, 67, 126, 131
 Key transpose 63, 66, 73, 126, 131

[L]

L-KF 111
 LCD contrast 14, 73
 Legata 90, 91
 Lev 111
 Level 36, 59, 84, 110, 111, 136
 Level key follow 37, 111
 LFO 23, 37, 41, 45, 95, 98, 144
 LFO delay 99
 LFO depth 37, 41, 45, 100

LFO fade time 99
 LFO offset 99
 LFO rate 98
 LFO synchro 98
 LFO waveform 98
 Local switch 66, 75, 131, 133
 Low pass filter 45, 105, 106, 147
 LPF 45, 106, 147

[M]

Master tune 73
 Master volume 9, 13
 Memory 28, 33, 56
 MIDI 26, 75, 76, 126, 128, 137, 164
 MIDI implementation chart 207
 MIDI control change 73, 76, 199, 207
 MIDI channel 60, 63, 75, 128, 137
 MIDI transmit switch 62, 63, 126, 129
 MIDI volume 55, 62, 76
 MIDI receive switch 59, 138
 Modulation 93
 Mute group 144

[O]

Output jack 9, 12
 Output mode 74
 Output switch 88, 122, 142

[P]

P.C 76
 P-KF 102, 112
 Pan 39, 59, 84, 110, 112, 136, 150
 Panning key follow 40, 110, 111
 Pan offset 110, 111
 Panic 71
 Parameter slider 9, 25, 34, 57, 80, 140
 Part 24, 51, 52, 116, 134
 Part level 59, 136
 Part pan 59, 136
 Part tune 59, 137
 Patch 23, 30, 78
 Patch edit 80
 Patch edit mode 78
 Patch level 84
 Patch name 35, 83

Patch number 35
 Patch pan 84
 Patch parameter 23, 30, 78
 Patch play mode 30
 Patch receive channel 75
 Patch select 60, 136
 Patch transmit channel 75
 PCM card 97, 144
 Pedal 1/2 12, 25, 73, 74, 93
 Performance 24, 51, 115
 Performance edit 115
 Performance edit mode 115
 Performance number 57
 Performance name 57, 120
 Performance parameter 24, 51, 115
 Performance play mode 51
 Pitch bend 18, 76, 90, 91
 Pitch coarse 145
 Pitch envelope 101, 103, 146
 Pitch envelope depth 41, 102, 145
 Pitch key follow 42, 102
 Pitch shift coarse 102
 Pitch shift fine 102, 145
 Play mode 30, 51
 Portamento 90, 92
 Portamento mode 92
 Portamento switch 92
 Portamento speed 92
 Portamento time 92
 Poly 91
 Polyphonic mode 91
 Power up mode 73
 Program change 62, 70, 76, 128
 Program change receive switch 61, 138
 Protect 155, 166

[R]

Random pitch depth 43, 102
 Receive channel 60, 137
 Receive MIDI 76
 Receive switch 61, 138
 Res 106, 147
 Resonance 46, 106, 147
 Resonance mode 46, 107, 147
 Reverb 39, 88, 123, 142
 Reverb button 19
 Reverb level 69, 88, 123, 142
 Reverb send level 39, 85, 87, 141
 Reverb switch 61, 138

Reverb time 69, 88, 123, 142
 Reverb type 88, 123
 Rhythm 139
 Rhythm edit mode 139
 Rhythm set 24, 139, 183
 Rhythm tone 139
 Rnd 102, 145
 ROM play 15
 Rx. 59, 60, 75

[S]

Send level 39, 86, 87
 Sequencer 53, 55, 194
 Solo 91
 Solo mode 91
 System common parameter 72

[T]

T-KF 107
 Temporary area 28, 30, 51
 Thresh 75
 Time-KF 104
 Time key follow 48, 50, 104, 113
 Time variant amplifier (TVA) 23, 36, 110, 150
 Time variant filter (TVF) 23, 44, 105, 147
 Tone 23, 30, 78
 Tone switch 35, 97, 144
 Tone select button 81, 110
 Tone delay 37, 112
 Tone delay time 37, 113
 Tone delay mode 38, 112
 Tone level 36, 110, 111
 Transmit channel 63, 75, 128
 Transmit max velocity 64, 127
 Transmit MIDI 76
 Transmit pan 62, 129
 Transmit program change 62, 70, 128
 Transmit switch 62, 63, 123, 129
 Transmit transpose 63, 126
 Transmit velocity curve 64, 127
 Transmit velocity sensitivity 63, 127
 Transmit volume 62, 128
 Transmit zone 24, 51, 62, 116, 125
 Transmit zone key range upper 65, 126
 Transmit zone key range lower 65, 126
 Transpose 63, 66, 73, 126, 131
 Transpose button 19

Tune 41, 43, 59, 73, 137
 Tuning 73
 TVA 23, 36, 79
 TVA envelope 49
 TVA envelope time key follow 50, 113
 TVA level 36
 TVA level key follow 37, 110, 111
 TVA velocity attack time sensitivity 113
 TVA velocity curve type 36, 111
 TVA velocity level sensitivity 44, 111
 TVA velocity release time sensitivity 113
 TVF 23, 32, 79
 TVF envelope 47, 48
 TVF envelope depth 44, 107
 TVF envelope time key follow 48, 109
 TVF cutoff 44, 105, 106
 TVF cutoff key follow 45, 105, 106
 TVF resonance 46
 TVF velocity attack time sensitivity 105, 108
 TVF velocity curve type 108
 TVF velocity envelope level sensitivity 44, 108, 148
 TVF velocity release time sensitivity 105, 108
 Tx 62, 126

【U】

Unit number 76, 159
 User memory 28, 33, 56

【V】

V-Crv 36, 64
 V-T1 108
 V-T4 108
 V-Time 150
 V-Tm 145, 148
 Vel 103, 108, 111, 145, 148
 Velo-Sw 84
 Velo-T1 103, 113
 Velo-T4 103, 113
 Voice reserve 60, 134, 137
 Volume 9, 13, 62, 128
 Velocity 18
 Velocity attack time sensitivity 103, 108, 113
 Velocity curve type 36, 64, 66, 108, 111
 Velocity envelope level sensitivity 44, 108
 Velocity range lower 84
 Velocity range switch 84
 Velocity range upper 84

Velocity release time sensitivity 103, 108, 113
 Velocity sensitivity 36, 108, 111, 113
 Velocity time sensitivity 148, 150
 Volume control switch 93
 Volume receive switch 61, 138

【W】

Wave generator 23, 79
 Wave number 97, 144
 Waveform 97, 144
 Wave group 97, 144
 Write mode 154

For Nordic Countries

Apparatus containing Lithium batteries

ADVARSEL!

Lithiumbatteri – Eksplosionsfare ved fejlagtig håndtering.
Udskiftning må kun ske med batteri af samme fabrikat og type.
Levér det brugte batteri tilbage til leverandøren.

VARNING!

Explosionsfara vid felaktigt batteribyte.
Använd samma batterityp eller en ekvivalent typ som rekommenderas av apparattillverkaren.
Kassera använt batteri enligt fabrikantens instruktion.

ADVARSEL!

Lithiumbatteri – Eksplosjonsfare.
Ved utskifting benyttes kun batteri som anbefalt av apparatfabrikanten.
Brukt batteri returneres apparatleverandøren.

VAROITUS!

Paristo voi räjähtää, jos se on virheellisesti asennettu.
Vaihda paristo ainoastaan laitevalmistajan suosittelemaan tyyppiin. Hävitä käytetty paristo valmistajan ohjeiden mukaisesti.

For Germany

Bescheinigung des Herstellers/Importeurs

Hiermit wird bescheinigt, daß der/die/das
ROLAND MULTI TIMBRAL SYNTHESIZER JV-80
(Gerät. Typ. Bezeichnung)

in Übereinstimmung mit den Bestimmungen der
Amtsbl. Vfg 1046/1984
(Amtsblattverfügung)

funk-entstört ist.

Der Deutschen Bundespost wurde das Inverkehrbringen dieses Gerätes angezeigt und die Berechtigung zur Überprüfung der Serie auf Einhaltung der Bestimmungen eingeräumt.

Roland Corporation Osaka/Japan

Name des Herstellers/Importeurs

For the USA

RADIO AND TELEVISION INTERFERENCE

WARNING — This equipment has been verified to comply with the limits for a Class B computing device, pursuant to Subpart J, of Part 15, of FCC rules. Operation with non-certified or non-verified equipment is likely to result in interference to radio and TV reception.

The equipment described in this manual generates and uses radio frequency energy. If it is not installed and used properly, that is, in strict accordance with our instructions, it may cause interference with radio and television reception. This equipment has been tested and found to comply with the limits for a Class B computing device in accordance with the specifications in Subpart J, of Part 15, of FCC Rules. These rules are designed to provide reasonable protection against such a interference in a residential installation. However, there is no guarantee that the interference will not occur in a particular installation. If this equipment does cause interference to radio or television reception, which can be determined by turning the equipment on and off, the user is encouraged to try to correct the interference by the following measure:

- Disconnect other devices and their input/output cables one at a time. If the interference stops, it is caused by either the other device or its I/O cable. These devices usually require Roland designated shielded I/O cables. For Roland devices, you can obtain the proper shielded cable from your dealer. For non Roland devices, contact the manufacturer or dealer for assistance.
- If your equipment does cause interference to radio or television reception, you can try to correct the interference by using one or more of the following measures.
 - Turn the TV or radio antenna until the interference stops.
 - Move the equipment to one side or the other of the TV or radio.
 - Move the equipment farther away from the TV or radio.
 - Plug the equipment into an outlet that is on a different circuit than the TV or radio. (That is, make certain the equipment and the radio or television set are on circuits controlled by different circuit breakers or fuses.)
 - Consider installing a rooftop television antenna with coaxial cable lead-in between the antenna and TV. If necessary, you should consult your dealer or an experienced radiotelevision technician for additional suggestions. You may find helpful the following booklet prepared by the Federal Communications Commission: "How to Identify and Resolve Radio — TV Interference Problems"

This booklet is available from the U.S. Government Printing Office, Washington, D.C., 20402, Stock No. 004-000-00345-4.

For Canada

CLASS B

NOTICE

This digital apparatus does not exceed the Class B limits for radio noise emissions set out in the Radio Interference Regulations of the Canadian Department of Communications.

CLASSE B

AVIS

Cet appareil numérique ne dépasse pas les limites de la classe B au niveau des émissions de bruits radioélectriques fixés dans le Règlement des signaux parasites par le ministère canadien des Communications.

